

General Specifications	
Operating Temperature	0° to 60°C (32° to 140°F)
Storage Temperature	-20° to 70°C (-4° to 158°F)
Humidity	5 to 95% (non-condensing)
Environmental Air	No corrosive gases permitted
Vibration	IEC60068-2-6 (Test Fc)
Shock	IEC60068-2-27 (Test Ea)
Enclosure Type	Open Equipment
Agency Approvals	UL 61010-1 and UL 61010-2-201 File E139594, Canada and USA CE (EN 61131-2 EMC, EN 61010-1 and EN 61010-2-201 Safety)
Noise Immunity	NEMA ICS3-304
EU Directive	See the "EU Directive" topic in the BRX Help File.
Weight	110g (3.9oz)
Heat Dissipation	3W
Software Version Required	Do-more! Designer Version V2.6, or later.

\*Meets EMC and Safety requirements. See the D.O.C. for details.

RTD Input Specifications	
Input Channels	4 Differential
Commons	4
Resolution	16-bit, $\pm 0.1^\circ\text{C}$ or $^\circ\text{F}$
Input Ranges (RTD Types)	Pt100 -200°C/850°C (-328°F/1562°F) Pt1000 -200°C/595°C (-328°F/1103°F) JPt100 -100°C/450°C (-148°F / 842°F) 10Ω Cu -200°C/260°C (-328°F / 500°F) $\pm 3^\circ\text{C}$ 25Ω Cu -200°C/260°C (-328°F / 500°F) $\pm 3^\circ\text{C}$ 120Ω Ni - 80°C/260°C (-112°F / 500°F)

RTD Input Specifications – Continued	
Input Resistance Ranges	0 – 10,000 Ω 0 – 6,250 Ω 0 – 3,125 Ω 0 – 1,562.5 Ω 0 – 781.2 Ω 0 – 390.6 Ω 0 – 195.3 Ω
RTD Linearization	Automatic
Excitation Current (all ranges)	210μA
Accuracy vs. Temperature	$\pm 10\text{ppm}$ per $^\circ\text{C}$ (maximum)
Full Scale Calibration	$\pm 1^\circ\text{C}$
Offset Calibration Error	$\pm 1^\circ\text{C}$ , $\pm 3^\circ\text{C}$ for 10Ω/25Ω Cu.
Maximum Inaccuracy	$\pm 1^\circ\text{C}$ , $\pm 3^\circ\text{C}$ for 10Ω/25Ω Cu. maximum (excluding RTD error) (including temperature drift)
Warm-up Time	2 minutes for $\pm 0.2\%$ repeatability
Sample Duration	Dependent on digital Filter Settings – 125ms@16Hz, 4ms@470Hz
Filter Characteristics	Digital filter cutoff frequencies: 16Hz, 470Hz
All Channel Update Rate	Single channel sample duration times the number of enabled channels
Open Circuit Detection Time	Positive full scale reading within 2s
Max. Common Mode Voltage	4VDC
Common Mode Rejection	-90dB min. @ DC, -150dB min. @ 50/60 Hz
Absolute Maximum Ratings	Fault protected input, $\pm 50\text{V}$
Conversion Method	Sigma-Delta

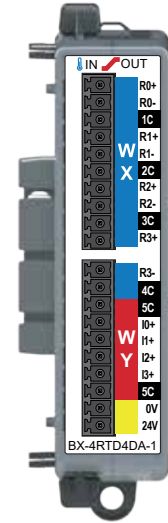

## BX-4RTD4DA-1

### Resistance Temperature Detector Input Analog Output Expansion Module

4-ch In, 4-ch Out, 16-bit

**I/O Terminal Blocks included.** (See Terminal Block Connector Spec. table inside.)  
 Not compatible with the ZIPLink Wiring System

**WARNING:** To minimize the risk of potential safety problems, you should follow all applicable local and national codes that regulate the installation and operation of your equipment. These codes vary from area to area and it is your responsibility to determine which codes should be followed, and to verify that the equipment, installation, and operation are in compliance with the latest revision of these codes.

**Equipment damage or serious injury to personnel can result from the failure to follow all applicable codes and standards. We do not guarantee the products described in this publication are suitable for your particular application, nor do we assume any responsibility for your product design, installation, or operation.**

If you have any questions concerning the installation or operation of this equipment, or if you need additional information, please call Technical Support at 770-844-4200.

This publication is based on information that was available at the time it was printed. At AutomationDirect.com® we constantly strive to improve our products and services, so we reserve the right to make changes to the products and/or publications at any time without notice and without any obligation. This publication may also discuss features that may not be available in certain revisions of the product.

Do-more BRX Manual available at  
[www.automationdirect.com/pn/doc/manual/BX-4RTD4DA-1](http://www.automationdirect.com/pn/doc/manual/BX-4RTD4DA-1)

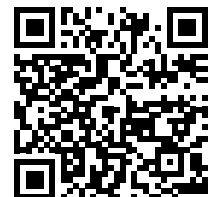

### IMPORTANT!



#### Hot-Swapping Information

**Note: This device cannot be Hot Swapped.**

Document Name	Edition/Revision	Date
BX-4RTD4DA-1	1st Ed.	11/3/2020

Copyright 2021, AutomationDirect.com Incorporated/All Rights Reserved Worldwide.

## I/O Wiring Terminal Block Input Wiring

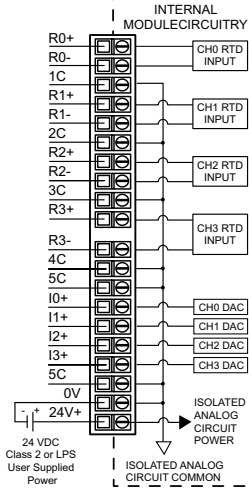

## Module Installation

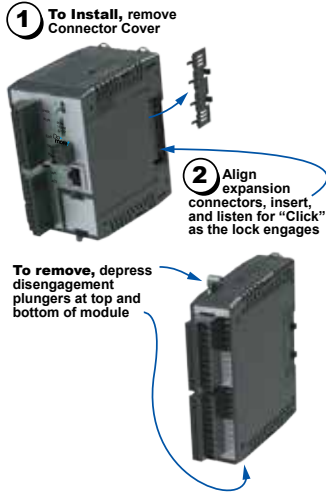

## Dimensional Information

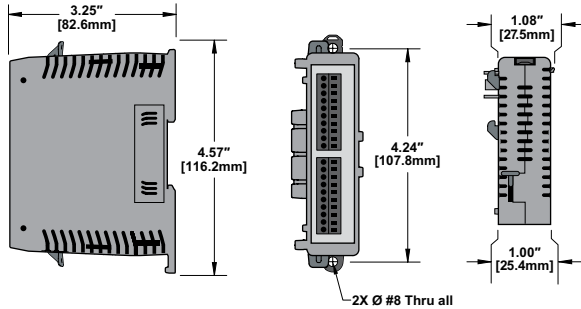

## I/O Wiring

### RTD Input Circuits

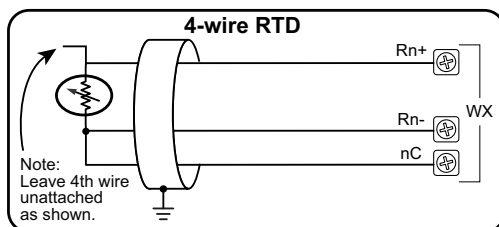
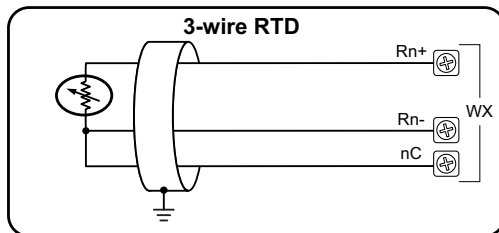
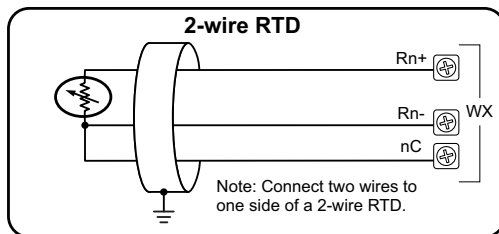

## Analog Current Output Specifications

Outputs per Module	4
Commons	1
Module Signal Output Range	0-20mA, 4-20mA (Default)
Signal Resolution	16 bit, 15 bit (Default)
Resolution Value of LSB (least significant bit) (@ 16 bit resolution)	(1 LSB = 1 count) 0-20mA = 0.305µA 4-20mA = 0.244µA
Output type	Current Sourcing up to 20mA
Output Value in Fault Mode	0mA in 0-20mA mode, 4mA in 4-20mA mode
Maximum Load Impedance	700Ω
Maximum Capacitive Load	1000pF
Allowed Load Type	Grounded
Maximum Continuous Overload	30mA
All Channel Update Rate	2.5ms per enabled channel
Maximum Inaccuracy	±0.1% of range
Maximum Full Scale Calibration Error	±0.08% of range
Maximum Offset Calibration Error	±0.08% of range
Conversion Method	Successive Approximation
Accuracy vs. Temperature	±25PPM / °C maximum
Maximum Crosstalk	+10µV
Linearity Error (end to end)	±0.08% of range
Output Stability and Repeatability	±0.03% of full range after 10 minute warm-up (typical)
Output Ripple	±0.03% of range/mA
Output Settling Time	320µs
Channel to Backplane Isolation	1800VAC applied for 1 second
Channel to Channel Isolation	None
Loop Fusing (external)	Fast-acting 0.032A recommended

## Module Power

Backplane Power Consumption	0.3W
External DC Power Required	Class 2 or LPS power supply 24VDC (±20%) 125mA

## I/O Wiring

### Notes for maximum accuracy:

- For 2-wire RTD, attach a third wire to module common.
- R+, R-, and COM wires to an RTD must be equal length and type. Refer to RTD manufacturer's recommendations.
- Do not use cable shield as sensing wire.
- When applicable, connect shield to RTD common only, otherwise connect to module common only. Do not connect shield to both ends.
- Jumper unused inputs to common.

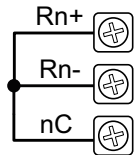

## Analog Current Source Output

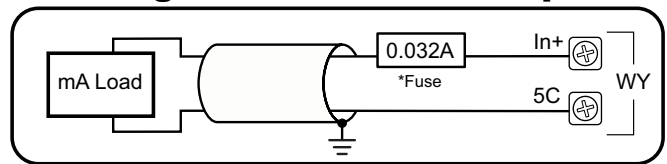

\*An Edison S500-32-R 0.032A fast-acting fuse is recommended for all analog voltage inputs, analog outputs, and current loops.

NOTE: Shield should be connected only at one end, to ground at the source device.

## Terminal Block Connector Specifications

Part Number	BX-RTB10 (Included)	BX-RTB10-1*	BX-RTB10-2*
Connector Type	Screw Type-90°	Spring Clamp Type-180°	Screw Type-180°
Pitch	3.81mm	3.81mm	3.81mm
Recommended Screw torque	<1.77 lb-in (0.2 N·m)	N/A	<1.77 lb-in (0.2 N·m)
Screwdriver Blade Width	2.5mm	2.5mm	2.5mm
Equiv. Dinkle part #	EC381V-10P-BK	ESC381V-10-BK	EC381F-10P-BK

\*Sold separately