



BRX-DM1-18ED2

BRX MPU with Do-more! DM1 technology
120 VAC required, serial port, microSD slot, Discrete Input: 10-point, sink / source, Discrete Output: 8-point, sourcing.

I/O Terminal Blocks sold separately.
(See Terminal Block Connection Options table).

Document Name	Edition/Revision	Date
BX-DM1-18ED2	1st Ed. RevD	9/8/2021

Copyright 2021, AutomationDirect.com Incorporated/All Rights Reserved Worldwide.

General Specifications	
Operating Temperature	0° to 60°C (32° to 140°F)
Storage Temperature	-20° to 85°C (-4° to 185°F)
Humidity	5 to 95% (non-condensing)
Environmental Air	No corrosive gases permitted
Vibration	IEC60068-2-6 (Test Fc)
Shock	IEC60068-2-27 (Test Ea)
Enclosure Type	Open Equipment
Agency Approvals	UL61010-2 - UL File # E185989 Canada and USA CE Compliant EN61131-2*
Noise Immunity	NEMA ICS3-304
EU Directive	See the "EU Directive" topic in the Help File
Weight	291g (10.3 oz)

*Meets EMC and Safety requirements. See the D.O.C. for details.

Power Supply Specifications	
Nominal Voltage Rating	120-240 VAC
Input Voltage Range (Tolerance)	85-264 VAC
Rated Operating Frequency	47-63 Hz
Maximum Input Power	40VA
Cold Start Inrush Current	1.5A, 2ms
Maximum Inrush Current (Hot Start)	1.5A, 2ms
Internal Input Fuse Protection	Micro fuse 250V, 2A Non-replaceable
Heat Dissipation	16.1W Max
Isolated User 24VDC Output	24VDC @ 0.3A max, <1V P-P Ripple, Integrated self-resetting short circuit protection
Voltage Withstand (dielectric)	1500VAC Power Inputs to Ground applied for 1 minute 1500VAC Ground to 24VDC applied for 1 minute

CPU Specifications	
Program Memory Type	FLASH memory
User Data Memory Type	Battery Backed RAM, User configurable
Pluggable Option Module	RS-232, RS-485, Ethernet 10/100 BASE-T (1Mbps throughput max), USB 2.0 Type B
Expansion Modules	4 expansion modules max
Real Time Clock Accuracy	±2.6s per day typical at 25°C ±8s per day max at 60°C
Programming Software	Do-more Designer – Ver. 2.0 or higher
Programming Cable Options	BX-PGM-CBL
Custom Label Window Size	0.75" x 2.25" (19mm x 57.2mm)

Terminal Block Connection Options	
BX-RTB18	Terminal Block Kit, 90-degree screw type, Fits all BRX 18-point PLCs. Kit includes (3) 5-pin 5mm plugs, (2) 6-pin 5mm plugs, (1) 3-pin 5mm plugs.
BX-RTB18-1	Terminal Block Kit, 180-degree spring clamp type, Fits all BRX 18-point PLCs. Kit includes (3) 5-pin 5mm plugs, (2) 6-pin 5mm plugs, (1) 3-pin 5mm plugs.
ZL-BX-CBL15	ZIPLink PLC I/O cable, 15-position terminal block to 24-pin connector, 24AWG. 0.5 meter (1.6 ft.) length, 2 required.
ZL-BX-CBL15-1	ZIPLink PLC I/O cable, 15-position terminal block to 24-pin connector, 24AWG. 1 meter (3.3 ft.) length, 2 required.
ZL-BX-CBL15-2	ZIPLink PLC I/O cable, 15-position terminal block to 24-pin connector, 24AWG. 2 meter (6.6 ft.) length, 2 required.
ZL-BX-CBL15-1P	ZIPLink PLC I/O cable, 15-position terminal block to pigtail connection, 24AWG. 1 meter (3.3 ft.) length, 2 required.
ZL-BX-CBL15-2P	ZIPLink PLC I/O cable, 15-position terminal block to pigtail connection, 24AWG. 2 meter (6.6 ft.) length, 2 required.
ZL-RTB20	ZIPLink Two-Level Feedthrough Module. 20 pole, 35mm DIN mount, 2 required.
ZL-RTB20-1	ZIPLink Three-Level Feedthrough Module. 20 pole, 35mm DIN mount, 2 required.

Built-in RS-232/485 Port Specifications	
Port Name	RS-232/RS-485 Serial Port
Description*	Non-isolated serial port that can communicate via RS-232 or RS-485 (software selectable). Includes ESD protection and built-in surge protection.
Supported Protocols	Do-more Protocol (Default) Modbus RTU (Master & Slave) K-Sequence (Slave) ASCII (In & Out)
Data Rates	1200, 2400, 4800, 9600, 19200, 38400, 57600, and 115200
Default Settings	RS-232, 115200 bps, No Parity, 8 Data Bits, 1 Stop Bit, Station #1
Port Type	3-pin terminal strip 3.5mm pitch
Port Status LED	Green LED is illuminated when active for TXD and RXD
RS-485 Station Addresses	1-247
Cable Recommendations	RS-232 use L19772-XXX from AutomationDirect.com RS-485 use L19827-XXX from AutomationDirect.com
Replacement Connector	ADC Part # BX-RTB03S

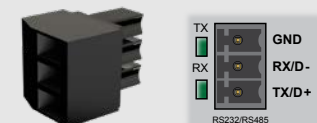

Pinout	RS232	RS485
1	GND	GND
2	RX	D-
3	TX	D+

Removable connector included.

* NOTE: When using RS-485, a terminator resistor is built-in and software selectable.

CPU Mode Switch Functions	
RUN position	CPU is forced into RUN Mode if no errors are encountered.
TERM position	RUN, PROGRAM and DEBUG modes are available. In this position, the mode of operation can be changed through the Do-more Designer Software.
STOP position	CPU is forced into STOP Mode.

Dimensional Information

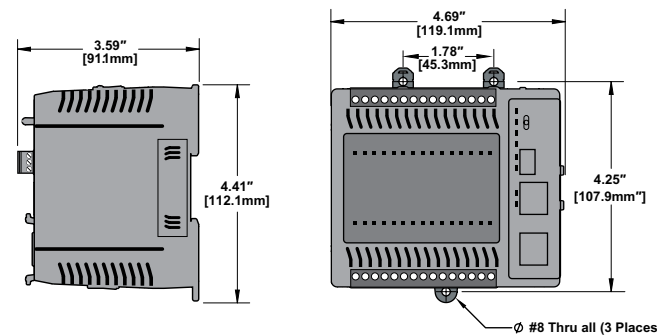

Mounting Restrictions

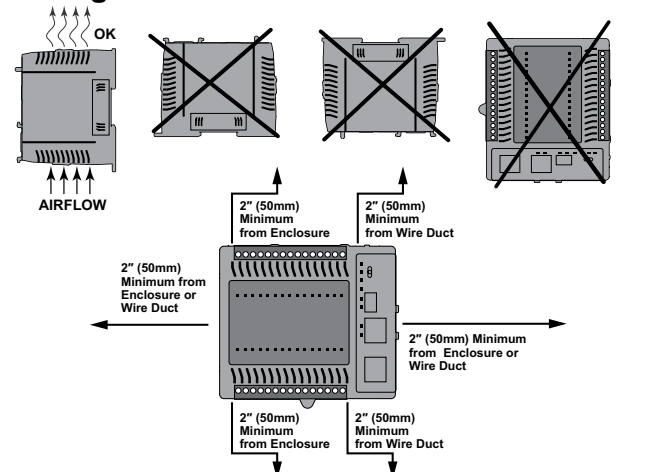

Terminal Block Connector Specifications			
Part Number	BX-RTB03S	BX-RTB18	BX-RTB18-1
Connector Type	Screw Type-90°	Screw Type-90°	Spring Clamp Type-180°
Wire Exit	180°	180°	180°
Pitch	3.5mm	5.0mm	5.0mm
Screw Size	M2	M2.5	N/A
Recommended Screw torque	<1.77 lb-in (0.2 N·m)	< 3.98 lb-in (0.45 N·m)	N/A
Screwdriver Blade Width	2.5mm	3.5mm	3.5mm
Wire Gauge (Single Wire)	28-16 AWG	28-12 AWG	28-14 AWG
Wire Gauge (Dual Wire)	28-16 AWG	28-16 AWG	28-16 AWG (Dual Wire Ferrule Required)
Wire Strip Length	0.24in (6mm)	0.3in (7.5mm)	0.37in (9.5mm)
Equiv. Dinkle part #	EC350V-03P-BK	5ESDV-0nP-BK*	5ESDSR-0nP-BK*

*NOTE: n=(3) 3-terminal, (5) 5-terminal, or (6) for 6-terminal

CPU Status Indicators		
Indicator	Status	Description
PWR	OFF	Base Power OFF
	Green	Base Power ON
	Yellow	Low Battery
RUN	OFF	CPU is in STOP Mode
	Green	CPU is in RUN Mode
	Yellow	Forces are Active
MEM	OFF	No ROM Activity, No SD Card
	Yellow	ROM Activity (Flash or SD Card)
	Green	SD Card Installed and Mounted
ERR	Red	SD Card Installed and Not Mounted
	OFF	CPU is functioning normally
	Red	CPU Fatal Hardware Error or Software Watchdog Error

Do-more BRX Manual available at www.automationdirect.com/pn/doc/manual/BX-DM1-18ED2



IMPORTANT!



Hot-Swapping Information

Note: This device cannot be Hot Swapped.

Terminal and Front Panel Layout

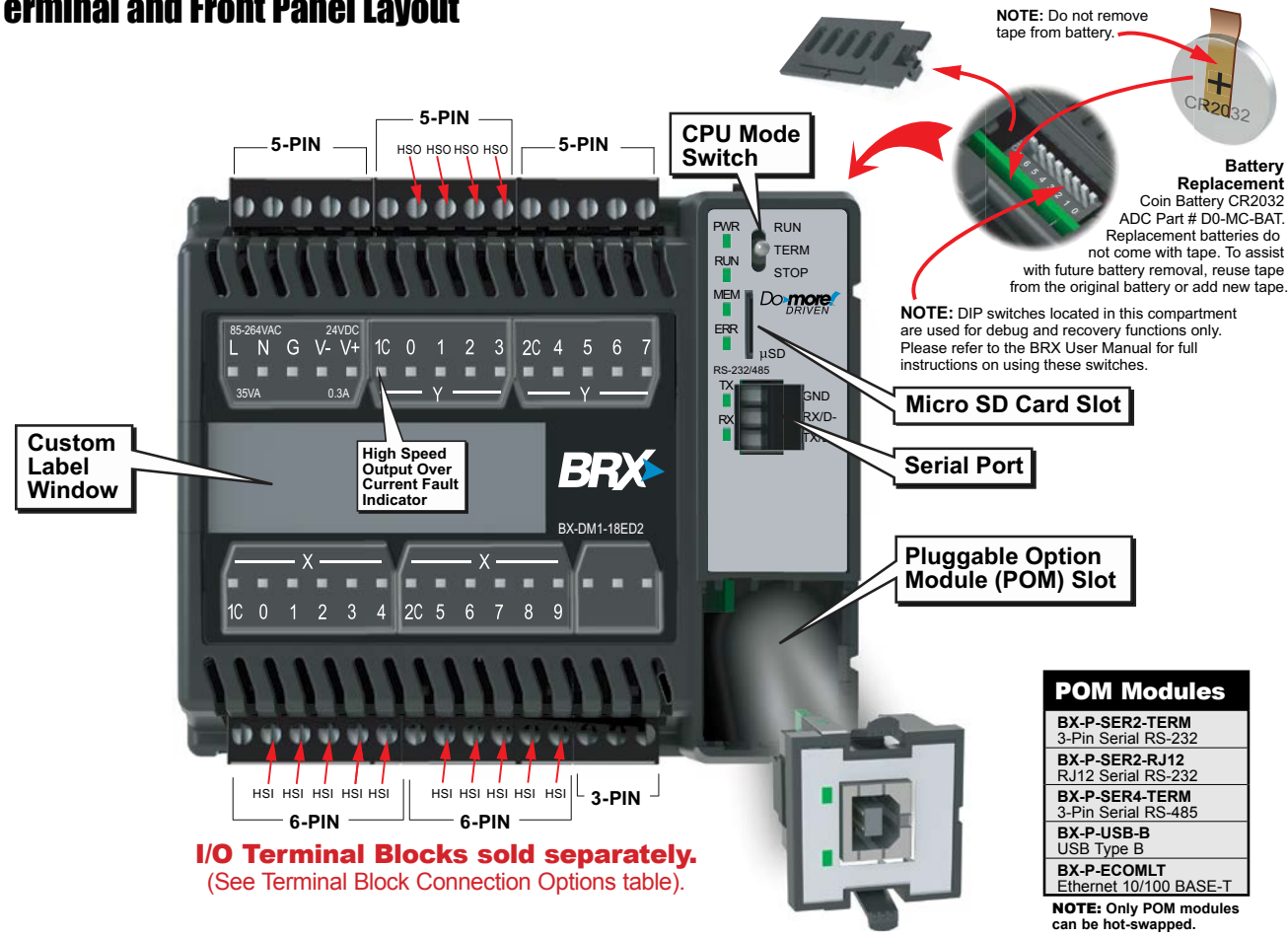

Discrete Input Specifications	
Input Type	Sink/Source
Total Inputs per Module	10 High Speed – All inputs may be used as standard inputs
Commons	2 (5 points/common) Isolated
Nominal Voltage Rating	12–24 VAC/DC
Input Voltage Range	9–30 VAC/DC
Maximum Voltage	30 VAC/DC
DC Frequency	0–250kHz - High Speed
Minimum Pulse Width	0.5 μs - High Speed
AC Frequency	47–63 Hz (60–240Hz filter must be set in software for AC operation)
Input Impedance	3kΩ @ 24VDC
Input Current (typical)	6mA @ 24 VAC/DC
Maximum Input Current	12mA @ 30 VAC/DC
Maximum OFF Current	2.0 mA
ON Voltage Level	> 9.0 VAC/VDC
OFF Voltage Level	< 2.0 VAC/VDC
Status Indicators	Logic Side, Green

Discrete Output Specifications	
Output Type	Sourcing
Total Outputs per Module	8 Total – 4 High Speed (Y0..Y3)* 4 Standard (Y4..Y7) *All outputs may be used as standard outputs
Commons	2 (4 points/common) Isolated
Maximum Current per Common	2A
Nominal Voltage Rating	12–24 VDC
Operating Voltage Range	5–36 VDC
Maximum Voltage	36VDC
Minimum Output Current	0.1mA @ 24VDC
Maximum Output Current	0.5 A per output, no derating over temperature range
Maximum Leakage Current	10μA
Maximum Switching Frequency	1m cable 250KHz 10m cable 100KHz
Status Indicators	Logic Side, Green

High Speed Input (HSI) Functions			
Input Function	Inputs Required ¹		10/10E 18/18E 36/36E
High-Speed Counting	1	Up counters	Up to (3)
	1	Down counters	
	2	Up/Down counters	
Position Scaling	2	Pulse/Direction (Bidirectional) counters	Up to (3)
	2	Quadrature (A and B) counters	
	3	Quadrature (A and B with Z) counters	
Frequency Measurement	1	Single Input (Edge) timers	Up to (3)
	2	Dual Input (Dual Edge) timers	
Interval Measurement	1	Single Input (Edge) timers	Up to (4)
Duration Measurement	1	Single Input (Edge) timers	
Table-Driven Output(s) ²		Programmable limit switches	Up to (4)
		Preset tables	
Interrupt(s)	4	Input interrupts	Up to (4)
	0	Timer interrupts	
	0	Match register interrupts	

1. Standard inputs may be used with high-speed functions, but at lower response frequencies of approximately 120Hz.
2. Table Driven Output(s) are triggered by an Axis Position or a high-speed counter/timer accumulator value. It requires the selection of 1 discrete output. (see HSO Note 1 below)

High Speed Output (HSO) Functions			
	Outputs Required ¹	Function ²	10/10E 18/18E 36/36E
Pulse Mode	0	Virtual axis	4 4 4
	2	PTO linear step/direction outputs	2 3 3
	2	PTO rotary clockwise/counter-clockwise (CW/CCW) outputs	2 3 3
	2	PTO quadrature (A and B) output	2 3 3
	1	PWM pulse width modulation outputs	4 4 4
Axis Profile		Relative/Absolute positioning, Velocity mode, Trapezoid, S-curve, Electronic gearing, Camming, Following, Homing, Jogging	

1. Standard outputs may be used for high-speed functions, but at lower response frequencies of approximately 110Hz. Use of relay outputs is not recommended.
2. This is the total number of functions. A combination of high-speed outputs and standard outputs may be used up to this total.

I/O Wiring

Discrete Input Wiring

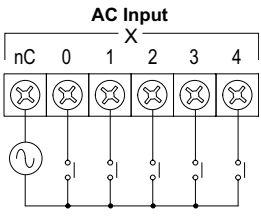
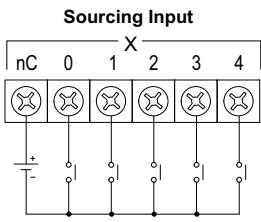
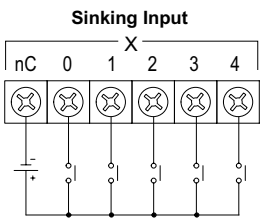

Discrete Output Wiring

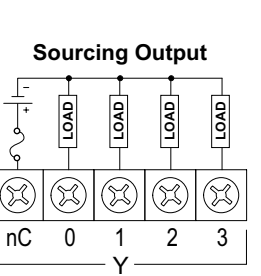

Supply Power Wiring

