

AC DRIVE PARAMETERS



TABLE OF CONTENTS

Chapter 4: AC Drive Parameters

Introduction	4-3
Video Tutorials	4-3
DURAPULSE GS20(X) Parameter Summary	4-3
Drive Parameters Summary (P00.xx)	4-3
Basic Parameters Summary (P01.xx)	4-10
Digital Input/Output Parameters Summary (P02.xx)	4-14
Analog Input/Output Parameters Summary (P03.xx)	4-20
Multi-Step Speed Parameters Summary (P04.xx)	4-23
Motor Parameters Summary (P05.xx)	4-24
Protection Parameters Summary (P06.xx)	4-27
Special Parameters Summary (P07.xx)	4-34
High-Function PID Parameters Summary (P08.xx)	4-37
Communication Parameters Summary (P09.xx)	4-39
Speed Feedback Control Parameters Summary (P10.xx)	4-42
Advanced Parameters Summary (P11.xx)	4-44
Macro / User Defined Macro Parameters Summary (P13.xx)	4-46
Protection Parameters (2) Summary (P14.xx)	4-48
DURAPULSE GS20(X) Parameter Details	4-50
Explanation of Parameter Details format	4-50
Group P00.xx Details – Drive Parameters	4-51
Group P01.xx Details – Basic Parameters	4-72
Group P02.xx Details – Digital Input/Output Parameters	4-83
Group P03.xx Details – Analog Input/Output Parameters	4-104
Analog Input Parameter Examples	4-116
Group P04.xx Details – Multi-Step Speed Parameters	4-139
Group P05.xx Details – Motor Parameters	4-141
Group P06.xx Details – Protection Parameters	4-150
Group P07.xx Details – Special Parameters	4-175
Group P08.xx Details – High-function PID Parameters	4-188
Group P09.xx Details – Communication Parameters	4-203
Group P10.xx Details – Speed Feedback Control Parameters	4-220
Group P11.xx Details – Advanced Parameters	4-229
Group P13.xx Details – Macro / User Defined Parameters	4-238
Group P14.xx Details – Protection Parameters (2)	4-251
Adjustments and Applications	4-257
FOC sensorless vector mode with standard induction motor (IM) adjustment procedure	4-257
TQC sensorless vector mode standard induction motor (IM) adjustment procedure	4-261
PMSVC mode with permanent magnet motor (PM) adjustment procedure	4-263

<i>Torque Calculation and Torque Parameter Setup Reference</i>	<i>4-267</i>
<i>Drive Motor Torque Calculation</i>	<i>4-267</i>
<i>GS20 Drive - Torque Limit in Speed Mode Detailed Explanation</i>	<i>4-268</i>
<i>Speed Mode with Torque Limits via Analog Input</i>	<i>4-269</i>
<i>GS20 Drive Quick Reference- Alternating between Torque and Speed Mode</i>	<i>4-270</i>

INTRODUCTION

This chapter covers all the parameters available for use with the GS20(X) series drives. The first section provides a summary of the parameters and some basic information. The second section provides detailed information about each parameter.

VIDEO TUTORIALS

Video tutorials for the GS20 family of drives are located here:

- www.automationdirect.com/videos (random search)
- www.automationdirect.com/cookbook (organized by subject/topic)

DURAPULSE GS20(X) PARAMETER SUMMARY

DRIVE PARAMETERS SUMMARY (P00.xx)

For detailed information about the P0.xx parameter group, please refer to [page 4-51](#).

GS20(X) Parameters Summary – Drive Parameters (P00.xx)						
Parameter	Range	Run ¹⁾ Read/ Write	Modbus Address		Settings	
			Hex	Dec	Default ²⁾	User
1) ♦ in the Run-Read/Write column indicates that the parameter can be set during RUN mode. R/W indicates "Read/Write." Read indicates "Read-only."						
2) Parameters can be restored to their <u>default values</u> using P00.02.						
P00.00	GS20 Model ID- Identity Code	102: 120 V, 1 Phase, 0.25 HP	Read	0000	40001	~
		103: 120 V, 1 Phase, 0.5 HP				
		104: 120 V, 1 Phase, 1 HP				
		302: 230 V, 1 Phase, 0.25 HP				
		303: 230 V, 1 Phase, 0.5 HP				
		304: 230 V, 1 Phase, 1 HP				
		305: 230 V, 1 Phase, 2 HP				
		306: 230 V, 1 Phase, 3 HP				
		202: 230 V, 3 Phase, 0.25 HP				
		203: 230 V, 3 Phase, 0.5 HP				
		204: 230 V, 3 Phase, 1 HP				
		205: 230 V, 3 Phase, 2 HP				
		206: 230 V, 3 Phase, 3 HP				
		207: 230 V, 3 Phase, 5 HP				
		208: 230 V, 3 Phase, 7.5 HP				
		209: 230 V, 3 Phase, 10 HP				
		210: 230 V, 3 Phase, 15 HP				
		211: 230 V, 3 Phase, 20 HP				
		403: 460 V, 3 Phase, 0.5 HP				
		404: 460 V, 3 Phase, 1 HP				
405: 460 V, 3 Phase, 2 HP						
406: 460 V, 3 Phase, 3 HP						
407: 460 V, 3 Phase, 5 HP						
408: 460 V, 3 Phase, 7.5 HP						
409: 460 V, 3 Phase, 10 HP						
410: 460 V, 3 Phase, 15 HP						
411: 460 V, 3 Phase, 20 HP						
412: 460 V, 3 Phase, 25 HP						
413: 460 V, 3 Phase, 30 HP						
504: 575 V, 3 Phase, 1 HP						
505: 575 V, 3 Phase, 2 HP						
506: 575 V, 3 Phase, 3 HP						
507: 575 V, 3 Phase, 5 HP						
508: 575 V, 3 Phase, 7.5 HP						
509: 575 V, 3 Phase, 10 HP						
P00.01	Rated Current	Display by models	Read	0001	40002	~

(table continued next page)

GS20(X) Parameters Summary – Drive Parameters (P00.xx) – (continued)

Parameter		Range	Run* Read/ Write	Modbus Address		Settings	
				Hex	Dec	Default	User
P00.02	Restore to Default	0: No function 1: Parameter Lock 2: Convert to GS2 mode (Step 1 of 2) 3: Not used 4: Not used 5: Reset kWh Display to 0 6: Reset PLC 8: Disable Keypad Run 9: Reset all parameters to 50Hz defaults 10: Reset all parameters to 60Hz defaults 11: Reset all parameters to 50Hz defaults (retain user-defined parameter values P13.01~P13.50) 12: Reset all parameters to 60Hz defaults (retain user-defined parameter values P13.01~P13.50) 13: Not used 20: Convert to GS2 mode (Step 2 of 2) Note: Reboot drive after resetting defaults.	R/W	0002	40003	0	
P00.03	Start-up display Selection	0: F – Freq Setpoint 1: H – Output Hz 2: U - User Display P00-04) 3: A – Output Amps	◆R/W	0003	40004	0	

(table continued next page)

GS20(X) Parameters Summary – Drive Parameters (P00.xx) – (continued)							
Parameter		Range	Run* Read/ Write	Modbus Address		Settings	
				Hex	Dec	Default	User
P00.04	User Display	0: Output Amps (A) (unit: Amp) 1: Counter Value (c) (unit: CNT) 2: Output Frequency (H.) (unit: Hz) 3: DC Bus Voltage (V) (unit: VDC) 4: Output Voltage (E) (unit: VAC) 5: Power Factor (n) (unit: deg) 6: Output Power (P) (unit: kW) 7: Calculated RPM (r) (unit: rpm) 8: Est Output Torque (t) (unit: %) 10: PID Feedback (b) (unit: %) 11: AI1 Analog Input Signal (1.) (unit: %) 12: AI2 Analog Input Signal (2.) (unit: %) 14: IGBT Temperature (i.) (unit: °C) 16: DI Input Status (ON / OFF) (i) 17: DO Output Status (ON / OFF) (o) 18: Multi-Speed Step (S) 19: CPU DI Input Status (d) 20: CPU DO Output Status (0.) 22: Pulse input frequency (S.) 25: Overload count (0.00–100.00%) (o.) (unit: %) 26: Ground fault GFF (G.) (unit: %) 27: DC bus voltage ripple (r.) (unit: VDC) 28: Display PLC register D1043 data (C) 30: Display the output of User-defined (U) 31: Display P00-05 user gain (K) 35: Control mode display 36: Present operating carrier frequency of the drive (J.) (Unit: Hz) 38: Display the drive status (6.) 39: Display the drive's estimated output torque, positive and negative, using N•m as unit (t 0.0: positive torque; -0.0: negative torque) (C.) 40: Torque command (L.) (unit: %) 41: kWh display (J) (unit: kWh) 42: PID target value (h.) (unit: %) 43: PID compensation (o.) (unit: %) 44: PID output frequency (b.) (unit: Hz) 46: Auxiliary frequency value (U.) (unit: Hz) 47: Master frequency value (A) (unit: Hz) 48: Frequency value after addition and subtraction of master and auxiliary frequency (L.) (unit: Hz) 51: PMSVC torque offset 58: P00.05 User gain display (K) (Does not display decimal places.) 62: I2t (o.) (unit: %) 63: Error code (E.) 64: Warning code (n.) 65: Accumulated motor operation record (day) (r.) (refer to P05.32)	◆R/W	0004	40005	3	
P00.05	Coefficient Gain in Actual Output Frequency Display (H Page scale)	0.00–160.00	◆R/W	0005	40006	1.00	
P00.06	Firmware version	Read only	Read	0006	40007	~	
P00.07	Parameter protection password input	0–65535 0–4: the number of password attempts allowed	◆R/W	0007	40008	0	

(table continued next page)

GS20(X) Parameters Summary – Drive Parameters (P00.xx) – (continued)							
Parameter		Range	Run* Read/ Write	Modbus Address		Settings	
				Hex	Dec	Default	User
P00.08	Parameter protection password setting	0-65535 0: No password protection or password entered correctly (P00-07) 1: Parameter has been set	◆R/W	0008	40009	0	
P00.10	Control Method	0: Speed Control mode 2: Torque mode	R/W	000A	40011	0	
P00.11	Speed (Velocity) Control mode	0: IMVF (V/F control) 1: IMVFPG (V/F control + encoder) 2: IM/PM SVC (IM or PM space vector control) 5: IMFOC Sensorless (field-oriented sensorless vector control) Note: For option 2 (SVC), see P05.33 for induction motor (IM) or permanent magnet (PM) motor selection.	R/W	000B	40012	0	
P00.16	Torque duty selection	0: Variable Torque (VT) 1: Constant Torque (CT)	R/W	0010	40017	1	
P00.17	Carrier frequency	Variable Torque: 2–15 kHz Constant Torque: 2–15 kHz Note: When P00-11=5 (IMFOC Sensorless), the maximum setting value for the carrier frequency is 10 kHz.	R/W	0011	40018	4	
P00.18	GS Series Number	20: GS20 series drive (GS21 or GS23) 21: GS20X series drive (GS21X or GS23X)	Read	0012	40019	–	
P00.19	PLC command mask	bit 0: Control command is forced by PLC control bit 1: Frequency command is forced by PLC control bit 3: Torque command is forced by PLC control	Read	0013	40020	0	
P00.20	Master frequency command source (AUTO, REMOTE)	0: Digital keypad 1: RS-485 communication input 2: External analog input (Refer to P03.00) 3: External UP / DOWN terminal (digital input terminals) 4: Pulse input (DI7) without direction command (refer to P10.16 for pulse input config) 6: Not used 7: Digital keypad VR/potentiometer dial (GS20 only) 8: Communication card 9: PID controller Note: HOA (Hand-Off-Auto) function is valid only when you use with digital input (DI) function setting 41/42 or 56 or with GS4-KPD (optional).	◆R/W	0014	40021	0	
P00.21	Operation command source (AUTO, REMOTE)	0: Digital keypad 1: External terminals 2: RS-485 communication input 3: Not used 5: Communication card Note: HOA (Hand-Off-Auto) function is valid only when you use with digital input (DI) function settings 41/42 or 56 or with GS4-KPD (optional)	◆R/W	0015	40022	0	
P00.22	Stop method	0: Ramp to stop 1: Coast to stop	◆R/W	0016	40023	0	

(table continued next page)

GS20(X) Parameters Summary – Drive Parameters (P00.xx) – (continued)							
Parameter		Range	Run* Read/ Write	Modbus Address		Settings	
				Hex	Dec	Default	User
P00.23	Motor direction control	0: Enable forward / reverse 1: Disable reverse 2: Disable forward	◆R/W	0017	40024	0	
P00.24	Digital operator (keypad) frequency command memory	Read only	Read	0018	40025	60	
P00.25	User-defined characteristics (COEFF ATT)	bit 0–3: user-defined decimal places 0000h,0000b: no decimal place 0001h,0001b: one decimal place 0002h,0010b: two decimal places 0003h,0011b: three decimal places bit 4–15: user-defined unit 000xh: Hz 001xh: rpm 002xh: % 003xh: kg 004xh: m/s 005xh: kW 006xh: HP 007xh: ppm 008xh: 1/m 009xh: kg/s 00Axh: kg/m 00Bxh: kg/h 00Cxh: lb/s 00Dxh: lb/m 00Exh: lb/h 00Fhx: ft/s 010xh: ft/m 011xh: m 012xh: ft 013xh: degC 014xh: degF 015xh: mbar 016xh: bar 017xh: Pa 018xh: kPa 019xh: mWG 01Axh: inWG 01Bxh: ftWG 01Cxh: psi 01Dxh: atm 01Exh: L/s 01Fhx: L/m 020xh: L/h 021xh: m ³ /s 022xh: m ³ /h 023xh: GPM 024xh: CFM	◆R/W	0019	40026	0	
P00.26	User-defined maximum value (COEFF MAX)	0: Disable 0–65535 (when P00.25 is set to no decimal place) 0.0–6553.5 (when P00.25 is set to one decimal place) 0.00–655.35 (when P00.25 is set to two decimal places) 0.000–65.535 (when P00.25 is set to three decimal places)	RW	001A	40027	0	
P00.27	User-defined value (COEFF SET)	Read only	Read	001B	40028	0	

(table continued next page)

GS20(X) Parameters Summary – Drive Parameters (P00.xx) – (continued)

Parameter	Range	Run* Read/ Write	Modbus Address		Settings		
			Hex	Dec	Default	User	
P00.29	LOCAL / REMOTE selection	0: Standard HOA function 1: When switching between local and remote, the drive stops. 2: When switching between local and remote, the drive runs with REMOTE settings for frequency and operating status. 3: When switching between local and remote, the drive runs with LOCAL settings for frequency and operating status. 4: When switching between local and remote, the drive runs with LOCAL settings when switched to Local and runs with REMOTE settings when switched to Remote for frequency and operating status.	R/W	001D	40030	4	
P00.30	Master frequency command source (HAND, LOCAL)	0: Digital keypad 1: RS-485 communication input 2: External analog input (refer to P03.00) 3: External UP / DOWN terminal (digital input terminals) 4: Pulse input without direction command (refer to P10.16 for pulse input config) 6: Not used 7: Digital keypad VR/potentiometer dial (GS20 only) 8: Communication card 9: PID controller Note: HOA (Hand-Off-Auto) function is valid only when you use with digital input (DI) function setting 41/42 or 56 or with GS4-KPD (optional).	◆R/W	001E	40031	0	
P00.31	Operation command source (HAND, LOCAL)	0: Digital keypad 1: External terminal 2: RS-485 communication input 3: Not used 5: Communication card Note: HOA (Hand-Off-Auto) function is valid only when you use with digital input (DI) function setting 41/42 or 56 or with GS4-KPD (optional).	◆R/W	001F	40032	0	
P00.32	Digital keypad STOP function	0: STOP key disabled 1: STOP key enabled	◆R/W	0020	40033	0	
P00.35	Auxiliary frequency source	0: Master and auxiliary frequency function disabled 1: Digital keypad 2: RS-485 communication input 3: Analog input 4: External UP / DOWN key input (digital input terminals) 5: Pulse input without direction command (refer to P10.16 for pulse input config) 6: Not used 7: Digital keypad VR/potentiometer dial (GS20 only) 8: Communication card	R/W	0023	40036	0	

(table continued next page)

GS20(X) Parameters Summary – Drive Parameters (P00.xx) – (continued)							
Parameter		Range	Run* Read/ Write	Modbus Address		Settings	
				Hex	Dec	Default	User
P00.36	Master and auxiliary frequency command selection	0: Master + auxiliary frequency 1: Master - auxiliary frequency 2: Auxiliary - master frequency	R/W	0024	40037	0	
P00.48	Display filter time (current)	0.001–65.535 sec.	◆R/W	0030	40049	0.100	
P00.49	Display filter time (keypad)	0.001–65.535 sec.	◆R/W	0031	40050	0.100	
P00.50	Date Code of Firmware version (date)	Read only	Read	0032	40051	0	

BASIC PARAMETERS SUMMARY (P01.xx)

For detailed information about the P01.xx parameter group, please refer to [page 4–72](#).

GS20(X) Parameters Summary – Basic Parameters (P01.xx)							
Parameter	Range	Run ¹⁾ Read/ Write	Modbus Address		Settings		User
			Hex	Dec	Default ²⁾		
1) ♦ in the Run-Read/Write column indicates that the parameter can be set during RUN mode. R/W indicates "Read/Write." Read indicates "Read-only."							
2) Parameters can be restored to their <u>default values</u> using P00.02.							
P01.00	Maximum operation frequency	0.00–599.00 Hz	R/W	0100	40257	60.00 / 50.00	
P01.01	Motor 1 Fbase	0.00–599.00 Hz	R/W	0101	40258	60.00 / 50.00	
P01.02	Motor 1, Rated Voltage (Nameplate)	120V / 230V models: 0.0–255.0 V 460V models: 0.0–510.0 V 575V models: 0.0–637.0 V	R/W	0102	40259	220.0 440.0 575.0	
P01.03	Motor 1, Mid-point frequency 1	0.00–599.00 Hz	R/W	0103	40260	3.00	
P01.04	Motor 1, Mid-point voltage 1	120V / 230V models: 0.0–240.0 V 460V models: 0.0–480.0 V 575V models: 0.0–600.0 V	♦R/W	0104	40261	11.0 22.0 40.0	
P01.05	Motor 1, Mid-point frequency 2	0.00–599.00 Hz	R/W	0105	40262	1.50	
P01.06	Motor 1, Mid-point voltage 2	120V / 230V models: 0.0–240.0 V 460V models: 0.0–480.0 V 575V models: 0.0–600.0 V	♦R/W	0106	40263	5.0 10.0 26.1	
P01.07	Motor 1, Minimum output frequency	0.00–599.00 Hz	R/W	0107	40264	0.50	
P01.08	Motor 1, Minimum output voltage	120V / 230V models: 0.0–240.0 V 460V models: 0.0–480.0 V 575V models: 0.0–600.0 V	♦R/W	0108	40265	1.0 2.0 16.7	
P01.09	Start-up frequency	0.00–599.00 Hz	R/W	0109	40266	0.50	
P01.10	Output frequency upper limit	0.00–599.00 Hz	♦R/W	010A	40267	599.00	
P01.11	Output frequency lower limit	0.00–599.00 Hz	♦R/W	010B	40268	0.00	
P01.12	Acceleration time 1	P01.45 = 0: 0.00–600.00 sec. P01.45 = 1: 0.0–6000.0 sec.	♦R/W	010C	40269	10.00 10.0	
P01.13	Deceleration time 1	P01.45 = 0: 0.00–600.00 sec. P01.45 = 1: 0.0–6000.0 sec.	♦R/W	010D	40270	10.00 10.0	
P01.14	Acceleration time 2	P01.45 = 0: 0.00–600.00 sec. P01.45 = 1: 0.0–6000.0 sec.	♦R/W	010E	40271	10.00 10.0	
P01.15	Deceleration time 2	P01.45 = 0: 0.00–600.00 sec. P01.45 = 1: 0.0–6000.0 sec.	♦R/W	010F	40272	10.00 10.0	
P01.16	Acceleration time 3	P01.45 = 0: 0.00–600.00 sec. P01.45 = 1: 0.0–6000.0 sec.	♦R/W	0110	40273	10.00 10.0	
P01.17	Deceleration time 3	P01.45 = 0: 0.00–600.00 sec. P01.45 = 1: 0.0–6000.0 sec.	♦R/W	0111	40274	10.00 10.0	
P01.18	Acceleration time 4	P01.45 = 0: 0.00–600.00 sec. P01.45 = 1: 0.0–6000.0 sec.	♦R/W	0112	40275	10.00 10.0	
P01.19	Deceleration time 4	P01.45 = 0: 0.00–600.00 sec. P01.45 = 1: 0.0–6000.0 sec.	♦R/W	0113	40276	10.00 10.0	
P01.20	JOG acceleration time	P01.45 = 0: 0.00–600.00 sec. P01.45 = 1: 0.0–6000.0 sec.	♦R/W	0114	40277	10.00 10.0	
P01.21	JOG deceleration time	P01.45 = 0: 0.00–600.00 sec. P01.45 = 1: 0.0–6000.0 sec.	♦R/W	0115	40278	10.00 10.0	
P01.22	JOG frequency	0.00–599.00 Hz	♦R/W	0116	40279	6.00	

(table continued next page)

GS20(X) Parameters Summary – Basic Parameters (P01.xx) – (continued)							
Parameter		Range	Run* Read/ Write	Modbus Address		Settings	
				Hex	Dec	Default	User
P01.23	TRANS ACC/DEC1-4 Switch frequency between first and fourth Accel./Decel.	0.00–599.00 Hz	◆R/W	0117	40280	0.00	
P01.24	S-curve for acceleration begin time 1	P01.45 = 0: 0.00–25.00 sec. P01.45 = 1: 0.0–250.0 sec.	◆R/W	0118	40281	0.20 0.2	
P01.25	S-curve for acceleration arrival time 2	P01.45 = 0: 0.00–25.00 sec. P01.45 = 1: 0.0–250.0 sec.	◆R/W	0119	40282	0.20 0.2	
P01.26	S-curve for deceleration begin time 1	P01.45 = 0: 0.00–25.00 sec. P01.45 = 1: 0.0–250.0 sec.	◆R/W	011A	40283	0.20 0.2	
P01.27	S-curve for deceleration arrival time 2	P01.45 = 0: 0.00–25.00 sec. P01.45 = 1: 0.0–250.0 sec.	◆R/W	011B	40284	0.20 0.2	
P01.28	Skip frequency 1 (upper limit)	0.00–599.00 Hz	R/W	011C	40285	0.00	
P01.29	Skip frequency 1 (lower limit)	0.00–599.00 Hz	R/W	011D	40286	0.00	
P01.30	Skip frequency 2 (upper limit)	0.00–599.00 Hz	R/W	011E	40287	0.00	
P01.31	Skip frequency 2 (lower limit)	0.00–599.00 Hz	R/W	011F	40288	0.00	
P01.32	Skip frequency 3 (upper limit)	0.00–599.00 Hz	R/W	0120	40289	0.00	
P01.33	Skip frequency 3 (lower limit)	0.00–599.00 Hz	R/W	0121	40290	0.00	
P01.34	Zero-speed mode	0: Output waiting 1: Zero-speed operation 2: Fmin (refer to P01.07 and P01.41)	R/W	0122	40291	0	
P01.35	Motor 2, Output frequency (Base frequency / Motor's rated frequency)	0.00–599.00 Hz	R/W	0123	40292	60.00 / 50.00	
P01.36	Motor 2, Output voltage (Base voltage / Motor's rated voltage)	120V / 230V models: 0.0–255.0 V 460V models: 0.0–510.0 V 575V models: 0.0–637.0 V	R/W	0124	40293	220.0 440.0 575.0	
P01.37	Motor 2, Mid-point frequency	0.00–599.00 Hz	R/W	0125	40294	3.0	
P01.38	Motor 2, Mid-point voltage 1	120V / 230V models: 0.0–240.0 V 460V models: 0.0–480.0 V 575V models: 0.0–600.0 V	◆R/W	0126	40295	11.0 22.0 40.0	
P01.39	Motor 2, Mid-point frequency 2	0.00–599.00 Hz	R/W	0127	40296	1.50	
P01.40	Motor 2, Mid-point voltage 2	120V / 230V models: 0.0–240.0 V 460V models: 0.0–480.0 V 575V models: 0.0–600.0 V	◆R/W	0128	40297	5.0 10.0 26.1	
P01.41	Motor 2, Minimum output frequency	0.00–599.00 Hz	R/W	0129	40298	0.50	
P01.42	Motor 2, Minimum output voltage	120V / 230V models: 0.0–240.0 V 460V models: 0.0–480.0 V 575V models: 0.0–600.0 V	◆R/W	012A	40299	1.0 2.0 16.7	
P01.43	V/F curve selection	0: V/F curve determined by P01.00–P01.08 1: V/F curve to the power of 1.5 2: V/F curve to the power of 2	R/W	012B	40300	0	

(table continued next page)

GS20(X) Parameters Summary – Basic Parameters (P01.xx) – (continued)							
Parameter		Range	Run* Read/ Write	Modbus Address		Settings	
				Hex	Dec	Default	User
P01.44	Auto-acceleration and auto-deceleration setting	0: Linear acceleration and deceleration 1: Auto-acceleration and linear deceleration 2: Linear acceleration and auto-deceleration 3: Auto-acceleration and auto-deceleration 4: Stall prevention by auto-acceleration and auto-deceleration (limited by P01.12 –P01.21)	◆R/W	012C	40301	0	
P01.45	Time unit for acceleration / deceleration and S-curve	0: Unit 0.01 sec. 1: Unit 0.1 sec.	R/W	012D	40302	0	
P01.49	Regenerative energy restriction control (decel method)	0: Disable 1: Over voltage energy restriction 2: Traction energy control (TEC)	R/W	0131	40306	0	
P01.52	Motor 2, Maximum operation frequency	0.00–599.00 Hz	R/W	0134	40309	60.00 / 50.00	
P01.53	Motor 3, Maximum operation frequency	0.00–599.00 Hz	R/W	0135	40310	60.00 / 50.00	
P01.54	Motor 3, Output frequency (Base frequency / Motor's rated frequency)	0.00–599.00 Hz	R/W	0136	40311	60.00 / 50.00	
P01.55	Motor 3, Output voltage (Base voltage / Motor's rated voltage)	120V / 230V models: 0.0–255.0 V 460V models: 0.0–510.0 V 575V models: 0.0–637.0 V	R/W	0137	40312	220.0 440.0 575.0	
P01.56	Motor 3, Mid-point frequency 1	0.00–599.00 Hz	R/W	0138	40313	3.00	
P01.57	Motor 3, Mid-point voltage 1	120V / 230V models: 0.0–240.0 V 460V models: 0.0–480.0 V 575V models: 0.0–600.0 V	◆R/W	0139	40314	11.0 22.0 40.0	
P01.58	Motor 3, Mid-point frequency 2	0.00–599.00 Hz	R/W	013A	40315	1.50	
P01.59	Motor 3, Mid-point voltage 2	120V / 230V models: 0.0–240.0 V 460V models: 0.0–480.0 V 575V models: 0.0–600.0 V	◆R/W	013B	40316	5.0 10.0 26.1	
P01.60	Motor 3, Minimum output frequency	0.00–599.00 Hz	R/W	013C	40317	0.50	
P01.61	Motor 3, Minimum output voltage	120V / 230V models: 0.0–240.0 V 460V models: 0.0–480.0 V 575V models: 0.0–600.0 V	◆R/W	013D	40318	1.0 2.0 16.7	
P01.62	Motor 4, Maximum operation frequency	0.00–599.00 Hz	R/W	013E	40319	60.00 / 50.00	
P01.63	Motor 4, Output frequency (Base frequency / Motor's rated frequency)	0.00–599.00 Hz	R/W	013F	40320	60.00 / 50.00	
P01.64	Motor 4, Output voltage (Base voltage / Motor's rated voltage)	120V / 230V models: 0.0–255.0 V 460V models: 0.0–510.0 V 575V models: 0.0–637.0 V	R/W	0140	40321	220.0 440.0 575.0	
P01.65	Motor 4, Mid-point frequency 1	0.00–599.00 Hz	R/W	0141	40322	3.00	
P01.66	Motor 4, Mid-point voltage 1	120V / 230V models: 0.0–240.0 V 460V models: 0.0–480.0 V 575V models: 0.0–600.0 V	◆R/W	0142	40323	11.0 22.0 40.0	

(table continued next page)

GS20(X) Parameters Summary – Basic Parameters (P01.xx) – (continued)							
Parameter		Range	Run* Read/ Write	Modbus Address		Settings	
				Hex	Dec	Default	User
P01.67	Motor 4, Mid-point frequency 2	0.00–599.00 Hz	R/W	0143	40324	1.50	
P01.68	Motor 4, Mid-point voltage 2	120V / 230V models: 0.0–240.0 V 460V models: 0.0–480.0 V 575V models: 0.0–600.0 V	◆R/W	0144	40325	5.0 10.0 26.1	
P01.69	Motor 4, Minimum output frequency	0.00–599.00 Hz	R/W	0145	40326	0.50	
P01.70	Motor 4, Minimum output voltage	120V / 230V models: 0.0–240.0 V 460V models: 0.0–480.0 V 575V models: 0.0–600.0 V	◆R/W	0146	40327	1.0 2.0 16.7	

DIGITAL INPUT/OUTPUT PARAMETERS SUMMARY (P02.xx)

For detailed information about the P02.xx parameter group, please refer to [page 4–83](#).

GS20(X) Parameters Summary – Digital Input/Output Parameters (P02.xx)						
Parameter	Range	Run ¹⁾ Read/ Write	Modbus Address		Settings	
			Hex	Dec	Default ²⁾	User
1) ♦ in the Run-Read/Write column indicates that the parameter can be set during RUN mode. R/W indicates "Read/Write." Read indicates "Read-only." 2) Parameters can be restored to their <u>default values</u> using P00.02.						
P02.00	Two-wire / three-wire operation control	R/W	0200	40513	1	
Note: On the drive, DI1 is labeled FWD, and DI2 is labeled REV. 0: No function 1: Two-wire mode 1, power on for operation control (DI1: FWD/STOP, DI2: REV/STOP) 2: Two-wire mode 2, power on for operation control (DI1: RUN/STOP, DI2: REV/FWD) 3: Three-wire, power on for operation control (DI1: RUN, DI2: REV/FWD, DI3: STOP) 4: Two-wire mode 1, Quick Start (DI1: FWD/STOP, DI2: REV/STOP) 5: Two-wire mode 2, Quick Start (DI1: RUN/STOP, DI2: REV/FWD) 6: Three-wire, Quick Start (DI1: RUN, DI2: REV/FWD, DI3: STOP) IMPORTANT 1) In the QuickStart function, terminal output remains in ready status, and the drive responds to the start command immediately. 2) When using the Quick Start function, output terminals U, V, and W are powered immediately. To avoid electric shock hazard, do not touch the terminals or modify the motor wiring.						

(table continued next page)

GS20(X) Parameters Summary – Digital Input/Output Parameters (P02.xx) – (continued)						
Parameter	Range	Run Read/Write	Modbus Address		Settings	
			Hex	Dec	Default	User
P02.01	Multi-function input command 1 (FWD/DI1)	R/W	0201	40514	0	
0: No function 1: Multi-step speed command 1 2: Multi-step speed command 2 3: Multi-step speed command 3 4: Multi-step speed command 4 5: Reset 6: JOG [by external control or GS4-KPD (optional)] 7: Acceleration / deceleration speed inhibit 8: 1st and 2nd acceleration / deceleration time selection 9: 3rd and 4th acceleration / deceleration time selection 10: External Fault (EF) Input (P07.20) 11: Base Block (B.B.) input from external source 12: Output stop 13: Cancel the setting of auto-acceleration / auto-deceleration time 15: Frequency command from AI1 16: Frequency command from AI2 18: Force to stop (P07.20) 19: Digital up command 20: Digital down command 21: PID function disabled 22: Clear the counter 23: Input the counter value (DI6) 24: FWD JOG command 25: REV JOG command 26: TQC / Field Oriented Control (FOC) mode selection 27: ASR1 / ASR2 selection 28: Emergency stop (EF1) 29: Signal confirmation for Y-connection 30: Signal confirmation for Δ-connection 31: High torque bias (P11.30) 32: Middle torque bias (P11.31) 33: Low torque bias (P11.32) 38: Disable writing EEPROM function 39: Torque command direction 40: Force coasting to stop 41: HAND switch 42: AUTO switch 48: Mechanical gear ratio switch 49: Enable drive 50: Slave dEb action to execute 51: Selection for PLC mode bit 0 52: Selection for PLC mode bit 1 56: Local / Remote selection						
<i>(table continued next page)</i>						

GS20(X) Parameters Summary – Digital Input/Output Parameters (P02.xx) – (continued)							
Parameter		Range	Run Read/Write	Modbus Address		Settings	
				Hex	Dec	Default	User
P02.01 (cont'd)	Multi-function input command 1 (FWD/DI1) (continued)	58: Enable fire mode (with RUN command) 59: Enable fire mode (without RUN command) 70: Force auxiliary frequency return to 0 71: Disable PID function, force PID output return to 0 72: Disable PID function, retain the output value before disabled 73: Force PID integral gain return to 0, disable integral 74: Reverse PID feedback 81: Simple positioning zero point position signal input 82: OOB loading balance detection 83: Multi-motor (IM) selection bit 0 84: Multi-motor (IM) selection bit 1	R/W	0201	40514	0	
P02.02	Multi-function input command 2 (REV/DI2)	See P02.01 for values.	R/W	0202	40515	0	
P02.03	Multi-function input command 3 (DI3)	See P02.01 for values.	R/W	0203	40516	1	
P02.04	Multi-function input command 4 (DI4)	See P02.01 for values.	R/W	0204	40517	2	
P02.05	Multi-function input command 5 (DI5)	See P02.01 for values.	R/W	0205	40518	3	
P02.06	Multi-function input command 6 (DI6)	See P02.01 for values.	R/W	0206	40519	4	
P02.07	Multi-function input command 7 (DI7)	See P02.01 for values. For pulse input, use selection 0 - No function.	R/W	0207	40520	0	
P02.09	UP / DOWN key mode	0: UP / DOWN by the acceleration / deceleration time 1: UP / DOWN constant speed (P02.10) 2: Pulse signal (P02.10) 3: External terminals UP / DOWN mode	◆R/W	0209	40522	0	
P02.10	Constant speed, acceleration / deceleration speed of the UP/DOWN Key	0.001–1.000 Hz/ms	◆R/W	020A	40523	0.001	
P02.11	Multi-function input response time	0.000–30.000 sec.	◆R/W	020B	40524	0.005	
P02.12	Multi-function input mode selection	0000h–FFFFh (0: N.O.; 1: N.C.)	◆R/W	020C	40525	0000	

(table continued next page)

GS20(X) Parameters Summary – Digital Input/Output Parameters (P02.xx) – (continued)							
Parameter		Range	Run Read/Write	Modbus Address		Settings	
				Hex	Dec	Default	User
P02.13	Multi-function output 1 (R1)	0: No function	◆R/W	020D	40526	11	
		1: Indication during RUN					
		2: Operation speed reached					
		3: Desired frequency reached 1 (P02.22)					
		4: Desired frequency reached 2 (P02.24)					
		5: Zero speed (Frequency command)					
		6: Zero speed including STOP (Frequency command)					
		7: Over-torque 1 (P06.06–06.08)					
		8: Over-torque 2 (P06.09–06.11)					
		9: Drive is ready					
		10: Low voltage warning (Lv) (P06.00)					
		11: Malfunction indication					
		13: Overheat warning (P06.15)					
		14: Software brake signal indicator (P07.00)					
		15: PID feedback error (P08.13, P08.14)					
		16: Slip error (oSL)					
		17: Count value reached, does not return to 0 (P02.20)					
		18: Count value reached, return to 0 (P02.19)					
		19: External interrupt B.B. input (Base Block)					
		20: Warning output					
		21: Over-voltage					
		22: Over-current stall prevention					
		23: Over-voltage stall prevention					
		24: Operation mode					
		25: Forward command					
		26: Reverse command					
		29: Output when frequency ≥ P02.34					
		30: Output when frequency < P02.34					
		31: Y-connection for the motor coil					
		32: Δ-connection for the motor coil					
		33: Zero speed (actual output frequency)					
		34: Zero speed including STOP (actual output frequency)					
		35: Error output selection 1 (P06.23)					
		36: Error output selection 2 (P06.24)					
		37: Error output selection 3 (P06.25)					
		38: Error output selection 4 (P06.26)					
		40: Speed reached (including STOP)					
		42: Crane function					
		43: Motor speed detection					
		44: Low current output (use with P06.71–06.73)					
		45: UVW output electromagnetic valve switch					
		46: Master dEb output					

(table continued next page)

GS20(X) Parameters Summary – Digital Input/Output Parameters (P02.xx) – (continued)							
Parameter		Range	Run Read/Write	Modbus Address		Settings	
				Hex	Dec	Default	User
P02.13 <i>(cont'd)</i>	Multi-function output 1 (R1) (continued)	51: Digital output control for serial modbus 52: Digital output control for communication card 53: Fire mode indication 66: SO output logic A 67: Analog input level reached 68: SO output logic B 73: Over-torque 3 74: Over-torque 4 75: Forward RUN status 76: Reverse RUN status	◆R/W	020D	40526	11	
P02.16	Multi-function output 2 (DO1)	See P02.13 for values.	◆R/W	0210	40529	0	
P02.17	Multi-function output 3 (DO2)	See P02.13 for values.	◆R/W	0211	40530	0	
P02.18	Multi-function output direction ACT	0000h–FFFFh (0: N.O.; 1: N.C.)	◆R/W	0212	40531	0000h	
P02.19	Terminal counting value reached (returns to 0)	0–65500	◆R/W	0213	40532	0	
P02.20	Preliminary (Middle) counting value reached (does not return to 0)	0–65500	◆R/W	0214	40533	0	
P02.21	Digital output gain (DO)	1–55	◆R/W	0215	40534	1	
P02.22	Desired frequency reached 1	0.00–599.00 Hz	◆R/W	0216	40535	60.00 / 50.00	
P02.23	The bandwidth of the desired frequency reached 1	0.00–599.00 Hz	◆R/W	0217	40536	2.00	
P02.24	Desired frequency reached 2	0.00–599.00 Hz	◆R/W	0218	40537	60.00 / 50.00	
P02.25	The bandwidth of the desired frequency reached 2	0.00–599.00 Hz	◆R/W	0219	40538	2.00	
P02.34	Output frequency setting for digital output terminal	0.00–599.00 Hz (Motor speed when using PG Card)	◆R/W	0222	40547	0.00	
P02.35	External operation control selection after fault reset and reboot	0: Disable 1: Drive runs if the RUN command remains after reset or reboot	◆R/W	0223	40548	0	
P02.47	Motor RPM zero-speed level	0–65535 rpm	◆R/W	022F	40560	0	
P02.50	Display the status of multi-function input terminals DI1-DI7	Monitor the status of multi-function input terminals	Read	0232	40563	0	
P02.51	Display the status of multi-function output terminals R1, DO1, DO2	Monitor the status of digital output terminals	Read	0233	40564	0	
P02.52	Display the external multi-function input terminals DI1-DI7 used by PLC	Monitor which inputs are controlled by the PLC	Read	0234	40565	0	

(table continued next page)

GS20(X) Parameters Summary – Digital Input/Output Parameters (P02.xx) – (continued)							
Parameter		Range	Run Read/Write	Modbus Address		Settings	
				Hex	Dec	Default	User
P02.53	Display the external multi-function output terminals R1, DO1, DO2 used by PLC	Monitor which outputs are controlled by the PLC	Read	0235	40566	0	
P02.54	Display the frequency command executed by external terminal (EXT Speed REC)	0.00–599.00 Hz (Read only)	Read	0236	40567	0	
P02.58	Multi-function output terminal (function 42): brake frequency check point	0.00–599.00 Hz	◆R/W	023A	40571	0.00	
P02.78	Motor deceleration gear ratio	4.0–1000.0	R/W	024E	40591	200.0	
P02.79	Automatic index positioning angle setting	0.0–6480.0	R/W	024F	40592	180.0	
P02.80	Automatic index positioning deceleration time	0.00: Disable the function 0.01–100.00 sec.	◆R/W	0250	40593	0.00	
P02.81	EF activates when the terminal count value reached	0: Terminal count value reached, no EF displays (continues to operate) 1: Terminal count value reached, EF activates	◆R/W	0251	40594	0	
P02.82	Initial Frequency com-mand (F) mode after stop	0: Use current Frequency command 1: Use zero Frequency Command 2: Refer to P02.83 to set up	◆R/W	0252	40595	0	
P02.83	Initial Frequency com-mand (F) setting after stop	0.00–599.00 Hz	◆R/W	0253	40596	60.00	

ANALOG INPUT/OUTPUT PARAMETERS SUMMARY (P03.xx)

For detailed information about the P03.xx parameter group, please refer to [page 4–104](#).

GS20(X) Parameters Summary – Analog Input/Output Parameters (P03.xx)							
Parameter	Range	Run ¹⁾ Read/ Write	Modbus Address		Settings		
			Hex	Dec	Default ²⁾	User	
1) ♦ in the Run-Read/Write column indicates that the parameter can be set during RUN mode. R/W indicates "Read/Write." Read indicates "Read-only."							
2) Parameters can be restored to their <u>default values</u> using using P00.02.							
P03.00	Analog input selection (AI1)	0: No function 1: Frequency command 2: Torque command (torque limit under speed mode) 3: Torque compensation command 4: PID target value 5: PID feedback signal 6: Thermistor (PTC) input value	♦R/W	0300	40769	1	
P03.01	Analog input selection (AI2)	7: Positive torque limit 8: Negative torque limit 9: Regenerative torque limit 10: Positive / negative torque limit 11: PT100 RTD input value 12: Auxiliary frequency input 13: PID compensation value	♦R/W	0301	40770	0	
P03.03	Analog input bias (AI1)	-100.0–100.0%	♦R/W	0302	40771	0	
P03.04	Analog input bias (AI2)	-100.0–100.0%	♦R/W	0303	40772	0	
P03.07	Positive / negative bias mode (AI1)	0: No bias 1: Lower than or equal to bias 2: Greater than or equal to bias	♦R/W	0304	40773	0	
P03.08	Positive / negative bias mode (AI2)	3: The absolute value of the bias voltage while serving as the center 4: Bias serves as the center	♦R/W	0308	40777	0	
P03.10	Reverse setting when analog signal input is negative frequency	0: Negative frequency input is not allowed. The digital keypad or external terminal controls the forward and reverse direction. 1: Negative frequency input is allowed. Positive frequency = run in a forward direction; negative frequency = run in a reverse direction. The digital keypad or external terminal control cannot change the running direction.	♦R/W	030A	40779	0	
P03.11	Analog input gain (AI1)	-500.0–500.0%	♦R/W	030B	40780	100.0	
P03.12	Analog input gain (AI2)	-500.0–500.0%	♦R/W	030C	40781	100.0	
P03.15	Analog input filter (LPF) time (AI1)	0.00–20.00 sec.	♦R/W	030F	40784	0.01	
P03.16	Analog input filter (LPF) time (AI2)	0.00–20.00 sec.	♦R/W	0310	40785	0.01	
P03.18	Analog input addition function	0: Disable (AI1, AI2) 1: Enable	♦R/W	0312	40787	0	
P03.19	Signal loss selection for analog input 4–20 mA	0: Disable 1: Continue operation at the last frequency 2: Decelerate to 0 Hz 3: Stop immediately and display "ACE"	R/W	0313	40788	0	

(table continued next page)

GS20(X) Parameters Summary – Analog Input/Output Parameters (P03.xx) – (continued)							
Parameter		Range	Run* Read/ Write	Modbus Address		Settings	
				Hex	Dec	Default	User
P03.20	Multi-function output (A01)	0: Output frequency (Hz) 1: Frequency command (Hz) 2: Motor speed (Hz) 3: Output current (rms) 4: Output voltage 5: DC bus voltage 6: Power factor 7: Power 8: Output torque 9: AI1 10: AI2 12: Iq current command 13: Iq feedback value 14: Id current command 15: Id feedback value 16: Vq-axis voltage command 17: Vd-axis voltage command 18: Torque command 19: PG2 (DI7) frequency command 21: RS-485 analog output 22: Communication card analog output 23: Constant voltage output	◆R/W	0314	40789	0	
P03.21	Analog output gain (A01)	0.0–500.0%	◆R/W	0315	40790	100.0	
P03.22	Analog output in REV direction (A01)	0: Absolute value in output voltage 1: Reverse output 0 V; forward output 0–10 V 2: Reverse output 5–0 V; forward output 5–10 V	◆R/W	0316	40791	0	
P03.27	A01 output bias	-100.00–100.00%	◆R/W	031B	40796	0.00	
P03.28	AI1 terminal input selection	0: 0–10 V (only P03.63–P03.68 are valid) 3: -10–10 V (only P03.63–P03.74 are valid)	◆R/W	031C	40797	0	
P03.29	AI2 terminal input selection	0: 4–20 mA 1: 0–10 V 2: 0–20 mA	◆R/W	031D	40798	0	
P03.30	PLC analog output terminal status	Monitor the status of the PLC analog output terminals bit 0: A01 status	Read	031E	40799	0	
P03.31	A01 output selection	0: 0–10 V output 1: 0–20 mA output 2: 4–20 mA output	◆R/W	031F	40800	0	
P03.32	A01 DC output setting level	0.00–100.00%	◆R/W	0320	40801	0.00	
P03.35	A01 output filter time	0.00–20.00 sec.	◆R/W	0323	40804	0.01	
P03.39	VR (keypad dial) input selection	0: Disable 1: Frequency command	◆R/W	0327	40808	1	
P03.40	VR (keypad dial) input bias	-100.0–100.0%	◆R/W	0328	40809	0.0	
P03.41	VR (keypad dial) positive / negative bias	0: No bias 1: Lower than or equal to bias 2: Greater than or equal to bias 3: The absolute value of the bias voltage while serving as the center 4: Bias serves as the center	◆R/W	0329	40810	0	
P03.42	VR (keypad dial) gain	-500.0–500.0%	◆R/W	032A	40811	100.0	
P03.43	VR (keypad dial) filter time	0.00–2.00 sec.	◆R/W	032B	40812	0.01	

(table continued next page)

GS20(X) Parameters Summary – Analog Input/Output Parameters (P03.xx) – (continued)							
Parameter		Range	Run* Read/ Write	Modbus Address		Settings	
				Hex	Dec	Default	User
P03.44	Multi-function output (DO) by AI level source	0: AI1 1: AI2	◆R/W	032C	40813	0	
P03.45	AI upper level	-100–100%	◆R/W	032D	40814	50	
P03.46	AI lower level	-100–100%	◆R/W	032E	40815	10	
P03.47	AI1%	-100–100%	Read	032F	40816	0	
P03.48	AI2%	-100–100%	Read	0330	40817	0	
P03.50	Analog input curve calculation selection	0: Normal curve 1: Three-point curve of AI1 2: Three-point curve of AI2 3: Three-point curve of AI1 & AI2	◆R/W	0332	40819	0	
P03.57	AI2 lowest point	P03.29 = 1, 0.00–10.00 V P03.29 ≠ 1, 0.00–20.00 mA	◆R/W	0339	40826	4.00	
P03.58	AI2 proportional lowest point	-100.00–100.00%	◆R/W	033A	40827	0.00	
P03.59	AI2 mid-point	P03.29 = 1, 0.00–10.00 V P03.29 ≠ 1, 0.00–20.00 mA	◆R/W	033B	40828	12.00	
P03.60	AI2 proportional mid-point	-100.00–100.00%	◆R/W	033C	40829	50.00	
P03.61	AI2 highest point	P03.29 = 1, 0.00–10.00 V P03.29 ≠ 1, 0.00–20.00 mA	◆R/W	033D	40830	20.00	
P03.62	AI2 proportional highest point	-100.00–100.00%	◆R/W	033E	40831	100.00	
P03.63	AI1 voltage lowest point	0.00–10.00 V	◆R/W	033F	40832	0.00	
P03.64	AI1 proportional lowest point	-100.00–100.00%	◆R/W	0340	40833	0.00	
P03.65	AI1 voltage mid-point	0.00–10.00 V	◆R/W	0341	40834	5.00	
P03.66	AI1 proportional mid-point	-100.00–100.00%	◆R/W	0342	40835	50.00	
P03.67	AI1 voltage highest point	0.00–10.00 V	◆R/W	0343	40836	10.00	
P03.68	AI1 proportional highest point	-100.00–100.00%	◆R/W	0344	40837	100.00	
P03.69	Negative AI1 voltage highest point	-10.00–0.00 V (valid when P03.28 sets as -10–10 V)	◆R/W	0345	40838	0.00	
P03.70	Negative AI1 proportional highest point	-100.00–100.00% (valid when P03.28 sets as -10–10 V)	◆R/W	0346	40839	0.00	
P03.71	Negative AI1 voltage mid-point	-10.00–0.00 V (valid when P03.28 sets as -10–10 V)	◆R/W	0347	40840	-5.00	
P03.72	Negative AI1 proportional mid-point	-100.00–100.00% (valid when P03.28 sets as -10–10 V)	◆R/W	0348	40841	-50.00	
P03.73	Negative AI1 voltage lowest point	-10.00–0.00 V (valid when P03.28 sets as -10–10 V)	◆R/W	0349	40842	-10.00	
P03.74	Negative AI1 proportional lowest point	-100.00–100.00% (valid when P03.28 sets as -10–10 V)	◆R/W	034A	40843	-100.00	

MULTI-STEP SPEED PARAMETERS SUMMARY (P04.xx)

For detailed information about the P04.xx parameter group, please refer to [page 4-139](#).

GS20(X) Parameters Summary – Multi-Step Speed Parameters (P04.xx)							
Parameter	Range	Run ¹⁾ Read/ Write	Modbus Address		Settings		User
			Hex	Dec	Default ²⁾		
1) ♦ in the Run-Read/Write column indicates that the parameter can be set during RUN mode. R/W indicates "Read/Write." Read indicates "Read-only."							
2) Parameters can be restored to their <u>default values</u> using P00.02.							
P04.00	1st step speed frequency	0.00–599.00 Hz	♦R/W	0400	41025	0.00	
P04.01	2nd step speed frequency	0.00–599.00 Hz	♦R/W	0401	41026	0.00	
P04.02	3rd step speed frequency	0.00–599.00 Hz	♦R/W	0402	41027	0.00	
P04.03	4th step speed frequency	0.00–599.00 Hz	♦R/W	0403	41028	0.00	
P04.04	5th step speed frequency	0.00–599.00 Hz	♦R/W	0404	41029	0.00	
P04.05	6th step speed frequency	0.00–599.00 Hz	♦R/W	0405	41030	0.00	
P04.06	7th step speed frequency	0.00–599.00 Hz	♦R/W	0406	41031	0.00	
P04.07	8th step speed frequency	0.00–599.00 Hz	♦R/W	0407	41032	0.00	
P04.08	9th step speed frequency	0.00–599.00 Hz	♦R/W	0408	41033	0.00	
P04.09	10th step speed frequency	0.00–599.00 Hz	♦R/W	0409	41034	0.00	
P04.10	11th step speed frequency	0.00–599.00 Hz	♦R/W	040A	41035	0.00	
P04.11	12th step speed frequency	0.00–599.00 Hz	♦R/W	040B	41036	0.00	
P04.12	13th step speed frequency	0.00–599.00 Hz	♦R/W	040C	41037	0.00	
P04.13	14th step speed frequency	0.00–599.00 Hz	♦R/W	040D	41038	0.00	
P04.14	15th step speed frequency	0.00–599.00 Hz	♦R/W	040E	41039	0.00	
P04.50	PLC buffer 0	0–65535	♦R/W	0432	41075	0	
P04.51	PLC buffer 1	0–65535	♦R/W	0433	41076	0	
P04.52	PLC buffer 2	0–65535	♦R/W	0434	41077	0	
P04.53	PLC buffer 3	0–65535	♦R/W	0435	41078	0	
P04.54	PLC buffer 4	0–65535	♦R/W	0436	41079	0	
P04.55	PLC buffer 5	0–65535	♦R/W	0437	41080	0	
P04.56	PLC buffer 6	0–65535	♦R/W	0438	41081	0	
P04.57	PLC buffer 7	0–65535	♦R/W	0439	41082	0	
P04.58	PLC buffer 8	0–65535	♦R/W	043A	41083	0	
P04.59	PLC buffer 9	0–65535	♦R/W	043B	41084	0	
P04.60	PLC buffer 10	0–65535	♦R/W	043C	41085	0	
P04.61	PLC buffer 11	0–65535	♦R/W	043D	41086	0	
P04.62	PLC buffer 12	0–65535	♦R/W	043E	41087	0	
P04.63	PLC buffer 13	0–65535	♦R/W	043F	41088	0	
P04.64	PLC buffer 14	0–65535	♦R/W	0440	41089	0	
P04.65	PLC buffer 15	0–65535	♦R/W	0441	41090	0	
P04.66	PLC buffer 16	0–65535	♦R/W	0442	41091	0	
P04.67	PLC buffer 17	0–65535	♦R/W	0443	41092	0	
P04.68	PLC buffer 18	0–65535	♦R/W	0444	41093	0	
P04.69	PLC buffer 19	0–65535	♦R/W	0445	41094	0	

MOTOR PARAMETERS SUMMARY (P05.xx)

For detailed information about the P05.xx parameter group, please refer to [page 4-141](#).

GS20(X) Parameters Summary – Motor Parameters (P05.xx)							
Parameter	Range	Run ¹⁾ Read/ Write	Modbus Address		Settings		User
			Hex	Dec	Default ²⁾		
1) ♦ in the Run-Read/Write column indicates that the parameter can be set during RUN mode. R/W indicates "Read/Write." Read indicates "Read-only." 2) Parameters can be restored to their <u>default values</u> using P00.02.							
P05.00	Motor parameter auto-tuning	0: No function 1: Dynamic test for induction motor (IM) 2: Static test for induction motor (IM) 5: Rolling auto-tuning for PM (IPM / SPM) 6: Simple rolling auto-tuning for induction motor (IM) 12: FOC sensorless inertia estimation (IM) 13: High frequency stall test for PM	R/W	0500	41281	0	
P05.01	Induction Motor 1, Full-load amps	10–120% of the drive's rated current	R/W	0501	41282	Model dependent	
P05.02	Induction Motor 1, Rated power (kW)	0.00–655.35 kW	♦R/W	0502	41283	Model dependent	
P05.03	Induction Motor 1, Rated speed (rpm)	0–xxxx rpm (Depending on the motor's number of poles) 1710 (60Hz, 4 poles); 1410 (50Hz, 4 poles)	♦R/W	0503	41284	1710	
P05.04	Induction Motor 1, Number of poles	2–20	R/W	0504	41285	4	
P05.05	Induction Motor 1, No-load amps	0.00–P05.01 default	R/W	0505	41286	Model dependent	
P05.06	Induction Motor 1, Stator resistance (Rs)	0.000–65.535 Ω	R/W	0506	41287	Model dependent	
P05.07	Induction Motor 1, Rotor resistance (Rr)	0.000–65.535 Ω	R/W	0507	41288	0.000	
P05.08	Induction Motor 1, Magnetizing inductance (Lm)	0.0–6553.5 mH	R/W	0508	41289	0.0	
P05.09	Induction Motor 1, Stator inductance (Lx)	0.0–6553.5 mH	R/W	0509	41290	0.0	
P05.13	Induction Motor 2, Full-load amps	10–120% of the drive's rated current	R/W	050D	41294	Model dependent	
P05.14	Induction Motor 2, Rated power (kW)	0.00–655.35 kW	♦R/W	050E	41295	Model dependent	
P05.15	Induction Motor 2, Rated speed (rpm)	0–xxxx rpm (Depending on the motor's number of poles) 1710 (60Hz, 4 poles); 1410 (50Hz, 4 poles)	♦R/W	050F	41296	1710	
P05.16	Induction Motor 2, Number of poles	2–20	R/W	0510	41297	4	
P05.17	Induction Motor 2, No-load amps	0.00–P05.13 default	R/W	0511	41298	Model dependent	
P05.18	Induction Motor 2, Stator resistance (Rs)	0.000–65.535 Ω	R/W	0512	41299	Model dependent	
P05.19	Induction Motor 2, Rotor resistance (Rr)	0.000–65.535 Ω	R/W	0513	41300	0.000	
P05.20	Induction Motor 2, Magnetizing inductance (Lm)	0.0–6553.5 mH	R/W	0514	41301	0.0	

(table continued next page)

GS20(X) Parameters Summary – Motor Parameters (P05.xx) – (continued)							
Parameter		Range	Run* Read/ Write	Modbus Address		Settings	
				Hex	Dec	Default	User
P05.21	Induction Motor 2, Stator inductance (Lx)	0.0–6553.5 mH	R/W	0515	41302	0.0	
P05.22	Multi-motor (induction) selection	1: Motor 1 2: Motor 2 3: Motor 3 (VF or SVC control mode only) 4: Motor 4 (VF or SVC control mode only)	R/W	0516	41303	1	
P05.23	Frequency for Y-connection / Δ-connection switch for an induction motor	0.00–599.00 Hz	◆R/W	0517	41304	60.00	
P05.24	Y-connection /Δ-connection switch for an induction motor	0: Disable 1: Enable	R/W	0518	41305	0	
P05.25	Delay time for Y-connection /Δ-connection switch for an induction motor	0.000–60.000 sec.	◆R/W	0519	41306	0.200	
P05.26	Accumulated Watt-second for a motor (W-msec.)	Read only	Read	051A	41307	0	
P05.27	Accumulated Watt-second for a motor (W-sec.)	Read only	Read	051B	41308	0	
P05.28	Accumulated Watt-hour for a motor (W-hour)	Read only	Read	051C	41309	0	
P05.29	Accumulated Watt-hour for a motor (kW-hour)	Read only	Read	051D	41310	0	
P05.30	Accumulated Watt-hour for a motor (MW-hour)	Read only	Read	051E	41311	0	
P05.31	Accumulated motor operation time (Minutes)	0–1439	R/W	051F	41312	0	
P05.32	Accumulated motor operation time (days)	0–65535	R/W	0520	41313	0	
P05.33	Induction motor (IM) or permanent magnet synchronous AC motor (PM) selection	0: IM (Induction motor) 1: SPM (Surface permanent magnet synchronous AC motor) 2: IPM (Interior permanent magnet synchronous AC motor)	R/W	0521	41314	0	
P05.34	Full-load current for a permanent magnet synchronous AC motor	0–120% of the drive’s rated current	R/W	0522	41315	Model dependent	
P05.35	Rated power for a permanent magnet synchronous AC motor	0.00–655.35 kW	R/W	0523	41316	Model dependent	
P05.36	Rated speed for a permanent magnet synchronous AC motor	0–65535 rpm	R/W	0524	41317	2000	
P05.37	Number of poles for a permanent magnet synchronous AC motor	0–65535	R/W	0525	41318	10	
P05.39	Stator resistance Rs for a permanent magnet synchronous AC motor	0.000–65.535 Ω	R/W	0527	41320	0.000	

(table continued next page)

GS20(X) Parameters Summary – Motor Parameters (P05.xx) – (continued)							
Parameter		Range	Run* Read/ Write	Modbus Address		Settings	
				Hex	Dec	Default	User
P05.40	Permanent magnet synchronous AC motor Ld	0.00–655.35 mH	R/W	0528	41321	0.00	
P05.41	Permanent magnet synchronous AC motor Lq	0.00–655.35 mH	R/W	0529	41322	0.00	
P05.43	Ke parameter of a permanent magnet synchronous AC motor	0–65535 (Unit: V / krpm)	R/W	052B	41324	0	
P05.64	Induction Motor 3, Full-load amps	10–120% of the drive's rated current	R/W	0540	41345	Model dependent	
P05.65	Induction Motor 3, Rated power (kW)	0.00–655.35 kW	◆R/W	0541	41346	Model dependent	
P05.66	Induction Motor 3, Rated speed (rpm)	0–xxxx rpm (Depending on the motor's number of poles) 1710 (60Hz, 4 poles); 1410 (50Hz, 4 poles)	◆R/W	0542	41347	1710	
P05.67	Induction Motor 3, Number of poles	2–20	R/W	0543	41348	4	
P05.68	Induction Motor 3, No-load amps	0.00–P05.64 default	R/W	0544	41349	Model dependent	
P05.69	Induction Motor 3, Stator resistance (Rs)	0.000–65.535 Ω	R/W	0545	41350	Model dependent	
P05.70	Induction Motor 4, Full-load amps	10–120% of the drive's rated current	R/W	0546	41351	Model dependent	
P05.71	Induction Motor 4, Rated power for (kW)	0.00–655.35 kW	◆R/W	0547	41352	Model dependent	
P05.72	Induction Motor 4, Rated speed (rpm)	0–xxxx rpm (Depending on the motor's number of poles) 1710 (60Hz, 4 poles); 1410 (50Hz, 4 poles)	◆R/W	0548	41353	1710	
P05.73	Induction Motor 4, Number of poles	2–20	R/W	0549	41354	4	
P05.74	Induction Motor 4, No-load amps	0.00–P05.70 default	R/W	054A	41355	Model dependent	
P05.75	Induction Motor 4, Stator resistance (Rs)	0.000–65.535 Ω	R/W	054B	41356	Model dependent	

PROTECTION PARAMETERS SUMMARY (P06.xx)

For detailed information about the P06.xx parameter group, please refer to [page 4–150](#).

GS20(X) Parameters Summary – Protection Parameters (P06.xx)							
Parameter	Range	Run ¹⁾ Read/ Write	Modbus Address		Settings		User
			Hex	Dec	Default ²⁾		
1) ♦ in the Run-Read/Write column indicates that the parameter can be set during RUN mode. R/W indicates "Read/Write." Read indicates "Read-only." 2) Parameters can be restored to their <u>default values</u> using P00.02.							
P06.00	Low voltage level	120V / 230V models: 150.0–220.0 VDC 460V models: 300.0–440.0 VDC 575V models: 375.0–550.0 VDC	♦R/W	0600	41537	180.0 360.0 450.0	
P06.01	Over-voltage stall prevention	0: Disable 120V / 230V models: 0.0–390.0 VDC 460V models: 0.0–900.0 VDC 575V models: 0.0–1000.0 VDC	♦R/W	0601	41538	380.0 760.0 975.0	
P06.02	Selection for over-voltage stall prevention	0: Traditional over-voltage stall prevention 1: Smart over-voltage stall prevention	♦R/W	0602	41539	0	
P06.03	Over-current stall prevention during acceleration (OCA)	VT: 0–150% (100% corresponds to the rated current of the drive) CT: 0–200% (100% corresponds to the rated current of the drive)	♦R/W	0603	41540	120 180	
P06.04	Over-current stall prevention during operation (OCN)	VT: 0–150% (100% corresponds to the rated current of the drive) CT: 0–200% (100% corresponds to the rated current of the drive)	♦R/W	0604	41541	120 180	
P06.05	Acceleration / deceleration time selection for stall prevention at constant speed	0: By current acceleration / deceleration time 1: By the first acceleration / deceleration time 2: By the second acceleration / deceleration time 3: By the third acceleration / deceleration time 4: By the fourth acceleration / deceleration time 5: By Auto-acceleration / auto-deceleration	♦R/W	0605	41542	0	
P06.06	Over-torque detection selection (motor 1)	0: No function 1: Continue operation after over-torque detection during constant speed operation 2: Stop after over-torque detection during constant speed operation 3: Continue operation after over-torque detection during RUN 4: Stop after over-torque detection during RUN	♦R/W	0606	41543	0	
P06.07	Over-torque detection level (motor 1)	10–250% (100% corresponds to the rated current of the drive)	♦R/W	0607	41544	120	
P06.08	Over-torque detection time (motor 1)	0.1–60.0 sec.	♦R/W	0608	41545	0.1	
(table continued next page)							

GS20(X) Parameters Summary – Protection Parameters (P06.xx) – (continued)							
Parameter		Range	Run* Read/ Write	Modbus Address		Settings	
				Hex	Dec	Default	User
P06.09	Over-torque detection selection (motor 2)	0: No function 1: Continue operation after over-torque detection during constant speed operation 2: Stop after over-torque detection during constant speed operation 3: Continue operation after over-torque detection during RUN 4: Stop after over-torque detection during RUN	◆R/W	0609	41546	0	
P06.10	Over-torque detection level (motor 2)	10–250% (100% corresponds to the rated current of the drive)	◆R/W	060A	41547	120	
P06.11	Over-torque detection time (motor 2)	0.1–60.0 sec.	◆R/W	060B	41548	0.1	
P06.12	Current limit	0–250% (100% corresponds to the rated current of the drive)	◆R/W	060C	41549	150	
P06.13	Electronic thermal relay selection 1 (motor 1)	0: Inverter motor (with external forced cooling) 1: Standard motor (motor with fan on the shaft) 2: Disabled	◆R/W	060D	41550	1	
P06.14	Electronic thermal relay action time 1 (motor 1)	30.0–600.0 sec.	◆R/W	060E	41551	60.0	
P06.15	Temperature level overheat (OH) warning	0.0–110.0°C	◆R/W	060F	41552	Model dependent	
P06.16	Stall prevention limit level (Weak magnetic field current stall prevention level)	0–100% (refer to P06.03–P06.04)	◆R/W	0610	41553	100	

(table continued next page)

GS20(X) Parameters Summary – Protection Parameters (P06.xx) – (continued)							
Parameter		Range	Run* Read/ Write	Modbus Address		Settings	
				Hex	Dec	Default	User
P06.17	Fault record 1	0: No fault record	Read	0611	41554	0	
		1: Over-current during acceleration (ocA)					
		2: Over-current during deceleration (ocd)					
		3: Over-current during steady operation (ocn)					
		4: Ground fault (GFF)					
		6: Over-current at stop (ocS)					
		7: Over-voltage during acceleration (ovA)					
		8: Over-voltage during deceleration (ovd)					
		9: Over-voltage during constant speed (ovn)					
		10: Over-voltage at stop (ovS)					
		11: Low-voltage during acceleration (LvA)					
		12: Low-voltage during deceleration (Lvd)					
		13: Low-voltage during constant speed (Lvn)					
		14: Low-voltage at stop (LvS)					
		15: Phase loss protection (orP)					
		16: IGBT overheating (oH1)					
		18: IGBT temperature detection failure (tH1o)					
		21: Over load (oL)					
		22: Electronic thermal relay 1 protection (EoL1)					
		23: Electronic thermal relay 2 protection (EoL2)					
		24: Motor PTC overheating (oH3)					
		26: Over torque 1 (ot1)					
		27: Over torque 2 (ot2)					
		28: Under current (uC)					
		31: EEPROM read error (cf2)					
		33: U-phase error (cd1)					
		34: V-phase error (cd2)					
		35: W-phase error (cd3)					
		36: cc (current clamp) hardware error (Hd0)					
		37: oc (over-current) hardware error (Hd1)					
		40: Auto-tuning error (AUE)					
		41: PID loss AI2 (AFE)					
		43: PG feedback loss (PGF2)					
		48: AI2 loss (ACE)					
		49: External fault (EF)					
		50: Emergency stop (EF1)					
		51: External Base Block (bb)					
		52: Password is locked (Pcod)					
		54: Illegal command (CE1)					
		55: Illegal data address (CE2)					
		56: Illegal data value (CE3)					
		57: Data is written to read-only address (CE4)					
		58: Modbus transmission time-out (CE10)					

(table continued next page)

GS20(X) Parameters Summary – Protection Parameters (P06.xx) – (continued)							
Parameter	Range	Run* Read/ Write	Modbus Address		Settings		
			Hex	Dec	Default	User	
P06.17 <i>(cont'd)</i>	Fault record 1 (continued)	61: Y-connection / Δ-connection switch error (ydc) 62: Deceleration energy backup error (dEb) 63: Over slip error (oSL) 72: STO Loss (STL1) 76: STO (STo) 77: STO Loss 2 (STL2) 78: STO Loss 3 (STL3) 79: U-phase Over-current before run (Aoc) 80: V-phase Over-current before run (boc) 81: W-phase Over-current before run (coc) 82: Output phase loss U phase (oPL1) 83: Output phase loss V phase (oPL2) 84: Output phase loss W phase (oPL3) 87: Low frequency overload protection (oL3) 89: Rotor position detection error (roPd) 97: Ethernet Card Timeout (CD10) 111: InrCOM time-out error (ictE) 121: Internal communication error (CP20) 123: Internal communication error (CP22) 124: Internal communication error (CP30) 126: Internal communication error (CP32) 127: Internal communication error (CP33) 128: Over-torque 3 (ot3) 129: Over-torque 4 (ot4) 134: Internal communication error (EoL3) 135: Internal communication error (EoL4) 140: Oc hardware error (Hd6) 141: GFF occurs before run (b4GFF) 142: Auto-tune error 1 (DC test stage) (AuE1) 143: Auto-tune error 2 (High frequency test stage) (AuE2) 144: Auto-tune error 3 (Rotary test stage) (AuE3) 149: Auto-tune error 5 (Rotor resistance measure test stage) (AuE5)	Read	0611	41554	0	
P06.18	Fault record 2	See P06.17 for ranges.	Read	0612	41555	0	
P06.19	Fault record 3	See P06.17 for ranges.	Read	0613	41556	0	
P06.20	Fault record 4	See P06.17 for ranges.	Read	0614	41557	0	
P06.21	Fault record 5	See P06.17 for ranges.	Read	0615	41558	0	
P06.22	Fault record 6	See P06.17 for ranges.	Read	0616	41559	0	
P06.23	Fault output option 1	0–65535 (refer to bit table for fault code)	◆R/W	0617	41560	0	
P06.24	Fault output option 2	0–65535 (refer to bit table for fault code)	◆R/W	0618	41561	0	
P06.25	Fault output option 3	0–65535 (refer to bit table for fault code)	◆R/W	0619	41562	0	
P06.26	Fault output option 4	0–65535 (refer to bit table for fault code)	◆R/W	061A	41563	0	
P06.27	Electronic thermal relay selection 2 (motor 2)	0: Inverter motor (with external forced cooling) 1: Standard motor (motor with fan on the shaft) 2: Disabled	◆R/W	061B	41564	1	

(table continued next page)

GS20(X) Parameters Summary – Protection Parameters (P06.xx) – (continued)							
Parameter		Range	Run* Read/ Write	Modbus Address		Settings	
				Hex	Dec	Default	User
P06.28	Electronic thermal relay action time 2 (motor 2)	30.0–600.0 sec.	◆R/W	061C	41565	60.0	
P06.29	PTC detection selection	0: Warn and continue operation 1: Fault and ramp to stop 2: Fault and coast to stop 3: No warning	◆R/W	061D	41566	0	
P06.30	PTC level	0.0–100.0%	◆R/W	061E	41567	50.0	
P06.31	Frequency command at malfunction	0.00–599.00 Hz	Read	061F	41568	0	
P06.32	Output frequency at malfunction	0.00–599.00 Hz	Read	0620	41569	0	
P06.33	Output voltage at malfunction	0.0–6553.5 V	Read	0621	41570	0	
P06.34	DC bus voltage at malfunction	0.0–6553.5 V	Read	0622	41571	0	
P06.35	Output current at malfunction	0.00–655.35 Amp	Read	0623	41572	0	
P06.36	IGBT temperature at malfunction	-3276.7–3276.7°C	Read	0624	41573	0	
P06.38	Motor speed at malfunction	-32767–32767 rpm	Read	0626	41575	0	
P06.39	Torque command at malfunction	-32767–32767%	Read	0627	41576	0	
P06.40	Status of the digital input terminal at malfunction	0000h–FFFFh	Read	0628	41577	0	
P06.41	Status of the digital output terminal at malfunction	0000h–FFFFh	Read	0629	41578	0	
P06.42	Drive status at malfunction	0000h–FFFFh	Read	062A	41579	0	
P06.43	IGBT Temperature	-3276.7–3276.7°C	Read	062B	41580	-	
P06.44	STO latch selection	0: STO latch 1: STO no latch	◆R/W	062C	41581	0	
P06.45	Output phase loss detection action (OPHL)	0: Warn and continue operation 1: Fault and ramp to stop 2: Fault and coast to stop 3: No warning	◆R/W	062D	41582	3	
P06.46	Detection time for output phase loss	0.000–65.535 sec.	◆R/W	062E	41583	0.500	
P06.47	Current detection level for output phase loss	0.00–100.00%	◆R/W	062F	41584	1.00	
P06.48	DC brake time for output phase loss	0.000–65.535 sec.	◆R/W	0630	41585	0.000	
P06.49	LvX auto-reset	0: Disable 1: Enable	R/W	0631	41586	0	
P06.53	Input phase loss detection action (OrP)	0: Fault and ramp to stop 1: Fault and coast to stop	◆R/W	0635	41590	0	

(table continued next page)

GS20(X) Parameters Summary – Protection Parameters (P06.xx) – (continued)							
Parameter		Range	Run* Read/ Write	Modbus Address		Settings	
				Hex	Dec	Default	User
P06.55	Derating protection	0: Constant rated current and limit carrier frequency by load current and temperature 1: Constant carrier frequency and limit load current by setting carrier frequency 2: Constant rated current (same as setting 0), but close current limit	◆R/W	0637	41592	0	
P06.56	PT100 RTD voltage level 1	0.000–10.000 V	◆R/W	0638	41593	5.000	
P06.57	PT100 RTD voltage level 2	0.000–10.000 V	◆R/W	0639	41594	7.000	
P06.58	PT100 RTD level 1 frequency protection	0.00–599.00 Hz	◆R/W	063A	41595	0.00	
P06.59	PT100 RTD activation level 1 protection frequency delay time	0–6000 sec.	◆R/W	063B	41596	60	
P06.60	Software detection GFF current level	0.0–6553.5%	◆R/W	063C	41597	60.0	
P06.61	Software detection GFF filter time	0.00–655.35 sec.	◆R/W	063D	41598	0.10	
P06.63	Operation time of fault record 1 (Days)	0–65535 days	Read	063F	41600	0	
P06.64	Operation time of fault record 1 (Minutes)	0–1439 min.	Read	0640	41601	0	
P06.65	Operation time of fault record 2 (Days)	0–65535 days	Read	0641	41602	0	
P06.66	Operation time of fault record 2 (Minutes)	0–1439 min.	Read	0642	41603	0	
P06.67	Operation time of fault record 3 (Days)	0–65535 days	Read	0643	41604	0	
P06.68	Operation time of fault record 3 (Minutes)	0–1439 min.	Read	0644	41605	0	
P06.69	Operation time of fault record 4 (Days)	0–65535 days	Read	0645	41606	0	
P06.70	Operation time of fault record 4 (Minutes)	0–1439 min.	Read	0646	41607	0	
P06.71	Low current setting level	0.0–100.0%	◆R/W	0647	41608	0.0	
P06.72	Low current detection time	0.00–360.00 sec.	◆R/W	0648	41609	0.00	
P06.73	Low current action	0: No function 1: Fault and coast to stop 2: Fault and ramp to stop by the second deceleration time 3: Warn and continue operation	◆R/W	0649	41610	0	
P06.80	Fire mode	0: Disable 1: Operates in a counterclockwise direction 2: Operates in a clockwise direction	R/W	0650	41617	0	
P06.81	Operating frequency in fire mode	0.00–599.00 Hz	◆R/W	0651	41618	60.00	
P06.88	Operation times in fire mode	0–65535 times	Read			0	

(table continued next page)

GS20(X) Parameters Summary – Protection Parameters (P06.xx) – (continued)							
Parameter		Range	Run* Read/ Write	Modbus Address		Settings	
				Hex	Dec	Default	User
P06.90	Operation time of fault record 5 (days)	0–65535 days	Read	065A	41627	0	
P06.91	Operation time of fault record 5 (Minutes)	0–1439 min.	Read	065B	41628	0	
P06.92	Operation time of fault record 6 (days)	0–65535 days	Read	065C	41629	0	
P06.93	Operation time of fault record 6 (Minutes)	0–1439 min.	Read	065D	41630	0	

SPECIAL PARAMETERS SUMMARY (P07.xx)

For detailed information about the P07.xx parameter group, please refer to [page 4-175](#).

GS20(X) Parameters Summary – Special Parameters (P07.xx)							
Parameter	Range	Run ¹⁾ Read/ Write	Modbus Address		Settings		
			Hex	Dec	Default ²⁾	User	
1) ♦ in the Run-Read/Write column indicates that the parameter can be set during RUN mode. R/W indicates "Read/Write." Read indicates "Read-only."							
2) Parameters can be restored to their <u>default values</u> using P00.02.							
P07.00	Software brake chopper threshold level	120V / 230V models: 350.0–450.0 VDC 460V models: 700.0–900.0 VDC 575V models: 875.0–1000.0 VDC	♦R/W	0000	41793	370.0 740.0 950.0	
P07.01	DC brake current level	0–100%	♦R/W	0701	41794	0	
P07.02	DC brake time at start-up	0.0–60.0 sec.	♦R/W	0702	41795	0.0	
P07.03	DC brake time at STOP	0.0–60.0 sec.	♦R/W	0703	41796	0.0	
P07.04	DC brake frequency at STOP	0.00–599.00 Hz	♦R/W	0704	41797	0.00	
P07.05	Voltage increasing gain	1–200%	♦R/W	0705	41798	100	
P07.06	Restart after momentary power loss	0: Stop operation 1: Speed tracking by the speed before the power loss 2: Speed tracking by the minimum output frequency	♦R/W	0706	41799	0	
P07.07	Allowed power loss duration	0.0–20.0 sec.	♦R/W	0707	41800	2.0	
P07.08	Base Block time	0.0–60.0 sec.	♦R/W	0708	41801	0.5	
P07.09	Current limit of speed tracking	20–200%	♦R/W	0709	41802	100	
P07.10	Restart after fault action	0: Stop operation 1: Speed tracking by current speed 2: Speed tracking by minimum output frequency	♦R/W	070A	41803	0	
P07.11	Number of times of restart after fault	0–10	♦R/W	070B	41804	0	
P07.12	Speed tracking during start-up	0: Disable 1: Speed tracking by the maximum output frequency 2: Speed tracking by the motor frequency at start-up 3: Speed tracking by the minimum output frequency	♦R/W	070C	41805	0	
P07.13	dEb function selection	0: Disable 1: dEb with auto-acceleration / auto-deceleration, the drive does not output the frequency after the power is restored. 2: dEb with auto-acceleration / auto-deceleration, the drive outputs the frequency after the power is restored. 3: dEb low-voltage control, then the drive's voltage increases to 350 VDC / 700 VDC and ramps to stop after low frequency 4: dEb high-voltage control of 350 VDC / 700 VDC, and the drive ramps to stop	♦R/W	070D	41806	0	

(table continued next page)

GS20(X) Parameters Summary – Special Parameters (P07.xx) – (continued)							
Parameter		Range	Run* Read/ Write	Modbus Address		Settings	
				Hex	Dec	Default	User
P07.15	Dwell time at acceleration	0.00–600.00 sec.	◆R/W	070F	41808	0.00	
P07.16	Dwell frequency at acceleration	0.00–599.00 Hz	◆R/W	0710	41809	0.00	
P07.17	Dwell time at deceleration	0.00–600.00 sec.	◆R/W	0711	41810	0.00	
P07.18	Dwell frequency at deceleration	0.00–599.00 Hz	◆R/W	0712	41811	0.00	
P07.19	Fan cooling control	0: Fan is always ON 1: Fan is OFF after the AC motor drive stops for one minute. 2: Fan is ON when the AC motor drive runs, fan is OFF when the AC motor drive stops. 3: Fan turns ON when temperature (IGBT) reaches approx 60°C.	◆R/W	0713	41812	3	
P07.20	Emergency stop (EF) & force to stop selection	0: Coast to stop 1: Stop by the first deceleration time 2: Stop by the second deceleration time 3: Stop by the third deceleration time 4: Stop by the fourth deceleration time 5: System deceleration 6: Automatic deceleration	◆R/W	0714	41813	0	
P07.21	Automatic energy-saving setting	0: Disable 1: Enable	◆R/W	0715	41814	0	
P07.22	Energy-saving gain	10–1000%	◆R/W	0716	41815	100	
P07.23	Automatic voltage regulation (AVR) function	0: Enable AVR 1: Disable AVR 2: Disable AVR during deceleration	◆R/W	0717	41816	0	
P07.24	Torque command filter time (V/F and SVC control mode)	0.001–10.000 sec.	◆R/W	0718	41817	0.050	
P07.25	Slip compensation filter time (V/F and SVC control mode)	0.001–10.000 sec.	◆R/W	0719	41818	0.100	
P07.26	Torque compensation gain (V/F and SVC control mode)	IM: 0–10 (when P05.33 = 0) PM: 0–5000 (when P05.33 = 1 or 2)	◆R/W	071A	41819	1	
P07.27	Slip compensation gain (V/F and SVC control mode)	0.00–10.00	◆R/W	071B	41820	0.00 (Default value is 1.00 in SVC mode)	
P07.29	Slip deviation level	0.0–100.0% 0: No detection	◆R/W	071D	41822	0	
P07.30	Over-slip deviation detection time	0.0–10.0 sec.	◆R/W	071E	41823	1.0	
P07.31	Over-slip deviation treatment	0: Warn and continue operation 1: Fault and ramp to stop 2: Fault and coast to stop 3: No warning	◆R/W	071F	41824	0	
P07.32	Motor oscillation compensation factor	0–10000	◆R/W	0720	41825	1000	
P07.33	Auto-restart interval of fault	0.0–6000.0 sec.	◆R/W	0721	41826	60.0	
P07.38	PMSVC voltage feed forward gain	0.50–2.00	R/W	0726	41831	1.00	
P07.46	OOB sampling time	0.1–120.0 sec.	R/W	072E	41839	1.0	

(table continued next page)

GS20(X) Parameters Summary – Special Parameters (P07.xx) – (continued)							
Parameter		Range	Run* Read/ Write	Modbus Address		Settings	
				Hex	Dec	Default	User
P07.47	Number of OOB sampling times	00–32	R/W	072F	41840	20	
P07.48	OOB average sampling angle	Read only	Read	0730	41841	0	
P07.62	dEb gain (Kp)	0–65535	◆R/W	073E	41855	8000	
P07.71	Torque compensation gain (motor 2)	IM: 0–10 (when P05.33 = 0) PM: 0–5000 (when P05.33 = 1 or 2)	◆R/W	0747	41864	1	
P07.72	Slip compensation gain (motor 2)	0.00–10.00	◆R/W	0748	41865	0.00 (Default value is 1.00 in SVC mode)	
P07.73	Torque compensation gain (motor 3)	IM: 0–10 (when P05.33 = 0) PM: 0–5000 (when P05.33 = 1 or 2)	◆R/W	0749	41866	1	
P07.74	Slip compensation gain (motor 3)	0.00–10.00	◆R/W	074A	41867	0.00 (Default value is 1.00 in SVC mode)	
P07.75	Torque compensation gain (motor 4)	IM: 0–10 (when P05.33 = 0) PM: 0–5000 (when P05.33 = 1 or 2)	◆R/W	074B	41868	1	
P07.76	Slip compensation gain (motor 4)	0.00–10.00	◆R/W	074C	41869	0.00 (Default value is 1.00 in SVC mode)	

HIGH-FUNCTION PID PARAMETERS SUMMARY (P08.xx)

For detailed information about the P08.xx parameter group, please refer to [page 4-188](#).

GS20(X) Parameters Summary – High-Function PID Parameters (P08.xx)							
Parameter	Range	Run ¹⁾ Read/ Write	Modbus Address		Settings		User
			Hex	Dec	Default ²⁾		
1) ♦ in the Run-Read/Write column indicates that the parameter can be set during RUN mode. R/W indicates "Read/Write." Read indicates "Read-only."							
2) Parameters can be restored to their <u>default values</u> using P00.02.							
P08.00	Terminal selection of PID feedback	0: No function 1: Negative PID feedback: by analog input (P03.00, P03.01) 2: Negative PID feedback: by single-phase input (DI7), without direction (P10.16=5) 4: Positive PID feedback: by analog input (P03.00, P03.01) 5: Positive PID feedback: by single-phase input (DI7), without direction (P10.16=5) 7: Negative PID feedback: by communication protocols 8: Positive PID feedback: by communication protocols	♦R/W	0800	42049	0	
P08.01	Proportional gain (P)	0.0–1000.0 (When P08.23 bit 1=0) 0.00–100.00 (When P08.23 bit 1=1)	♦R/W	0801	42050	1.00	
P08.02	Integral time (I)	0.00–100.00 sec.	♦R/W	0802	42051	1.00	
P08.03	Differential time (D)	0.00–1.00 sec.	♦R/W	0803	42052	0.00	
P08.04	Upper limit of integral control	0.0–100.0%	♦R/W	0804	42053	100.0	
P08.05	PID output command limit (positive limit)	0.0–110.0%	♦R/W	0805	42054	100.0	
P08.06	PID feedback value by communication protocol	-200.00–200.00%	♦R/W	0806	42055	0.00	
P08.07	PID delay time	0.0–2.5 sec.	♦R/W	0807	42056	0.0	
P08.08	Feedback signal detection time	0.0–3600.0 sec.	♦R/W	0808	42057	0.0	
P08.09	Feedback signal fault treatment	0: Warn and continue operation 1: Fault and ramp to stop 2: Fault and coast to stop 3: Warn and operate at last frequency	♦R/W	0809	42058	0	
P08.10	Sleep frequency	0.00–599.00 Hz	♦R/W	080A	42059	0.00	
P08.11	Wake-up frequency	0.00–599.00 Hz	♦R/W	080B	42060	0.00	
P08.12	Sleep time	0.0–6000.0 sec.	♦R/W	080C	42061	0.0	
P08.13	PID feedback signal error deviation level	1.0–50.0%	♦R/W	080D	42062	10.0	
P08.14	PID feedback signal error deviation detection time	0.1–300.0 sec.	♦R/W	080E	42063	5.0	
P08.15	PID feedback signal filter time	0.1–300.0 sec.	♦R/W	080F	42064	5.0	
P08.16	PID compensation selection	0: Parameter setting 1: Analog input	♦R/W	0810	42065	0	
P08.17	PID compensation	-100.0–100.0%	♦R/W	0811	42066	0	
P08.18	Sleep mode function setting	0: Refer to PID output command 1: Refer to PID feedback signal	R/W	0812	42067	0	
P08.19	Wake-up integral limit	0.0–200.0%	♦R/W	0813	42068	50.0	

(table continued next page)

GS20(X) Parameters Summary – High-Function PID Parameters (P08.xx) – (continued)							
Parameter		Range	Run* Read/ Write	Modbus Address		Settings	
				Hex	Dec	Default	User
P08.20	PID mode selection	0: Dependent ISA PID structure 1: Independent ISA PID structure	R/W	0814	42069	0	
P08.21	Enable PID to change the operation direction	0: Operation direction cannot be changed 1: Operation direction can be changed	R/W	0815	42070	0	
P08.22	Wake-up delay time	0.00–600.00 sec.	◆R/W	0816	42071	0.00	
P08.23	PID control flag	bit 0 = 1: PID running in reverse follows the setting for P00.23. bit 0 = 0: PID running in reverse refers to PID's calculated value. bit 1 = 1: two decimal places for PID Kp bit 1 = 0: one decimal place for PID Kp	◆R/W	0817	42072	2	
P08.26	PID output command limit (reverse limit)	0.0–100.0%	◆R/W	081A	42075	100.0	
P08.27	Acceleration / deceleration time for PID command	0.00–655.35 sec.	◆R/W	081B	42076	0.00	
P08.29	Frequency base corresponding to 100.00% PID	0: PID control output 100.00% corresponding to maximum operation frequency (P01.00) 1: PID control output 100.00% corresponding to the input value of the auxiliary frequency	◆R/W	081D	42078	0	
P08.31	Proportional gain 2	0.0–1000.0 (when P08.23 setting bit1=0) 0.00–100.00 (when P08.23 setting bit1=1)	◆R/W	081F	42080	1.00	
P08.32	Integral time 2	0.00–100.00 sec.	◆R/W	0820	42081	1.00	
P08.33	Differential time 2	0.00–1.00 sec.	◆R/W	0821	42082	0.00	
P08.65	PID target value source	0: Frequency command (P00.20, P00.30) 1: P08.66 setting 2: RS-485 communication input 3: External analog input (refer to P03.00, P03.01) 6: Communication card 7: Digital keypad potentiometer dial (GS20 only)	◆R/W	0841	42114	0	
P08.66	PID target value setting	-100.00–100.00%	◆R/W	0842	42115	50.00	
P08.67	Master and auxiliary reverse running cutoff frequency	0.0–100.0%	◆R/W	0843	42116	10.0	
P08.68	PID deviation limit	0.00–100.00%	◆R/W	0844	42117	0.00	
P08.69	Integral separation level	0.00–100.00%	◆R/W	0845	42118	0.00	
P08.70	Smart start-up level	0.00–100.00%	R/W	0846	42119	5.00	
P08.71	Smart start-up frequency command	0.00–599.00 Hz	◆R/W	0847	42120	0.00	
P08.72	Smart start-up acceleration time	0.00–600.00 sec.	◆R/W	0848	42121	3.00	
P08.75	PID2 parameter switch condition	0: No switching (refer to P08.01–P08.03) 1: Auto-switch based on the output frequency 2: Auto-switch based on the deviation	◆R/W	084B	42124	0	
P08.76	PID2 parameter switch deviation 1	0.00–P08.77%	◆R/W	084C	42125	10.00	
P08.77	PID2 parameter switch deviation 2	P08.76–100.00%	◆R/W	084D	42126	40.00	
P08.78	Allowed reverse running time after start-up	0.0–6553.5 sec.	◆R/W	084E	42127	0.0	

COMMUNICATION PARAMETERS SUMMARY (P09.xx)

For detailed information about the P09.xx parameter group, please refer to [page 4–203](#).

GS20(X) Parameters Summary – Communication Parameters (P09.xx)							
Parameter	Range	Run ¹⁾ Read/ Write	Modbus Address		Settings		User
			Hex	Dec	Default ²⁾		
1) ♦ in the Run-Read/Write column indicates that the parameter can be set during RUN mode. R/W indicates "Read/Write." Read indicates "Read-only."							
2) Parameters can be restored to their <u>default values</u> using P00.02.							
P09.00	Communication address	1–254	♦R/W	0900	42305	1	
P09.01	COM1 transmission speed	4.8–115.2 Kbps	♦R/W	0901	42306	9.6	
P09.02	COM1 transmission fault treatment	0: Warn and continue operation 1: Fault and ramp to stop 2: Fault and coast to stop 3: No warning, no fault, and continue operation	♦R/W	0902	42307	3	
P09.03	COM1 time-out detection	0.0–100.0 sec.	♦R/W	0903	42308	0.0	
P09.04	COM1 communication protocol	1: 7, N, 2 (ASCII) 2: 7, E, 1 (ASCII) 3: 7, O, 1 (ASCII) 4: 7, E, 2 (ASCII) 5: 7, O, 2 (ASCII) 6: 8, N, 1 (ASCII) 7: 8, N, 2 (ASCII) 8: 8, E, 1 (ASCII) 9: 8, O, 1 (ASCII) 10: 8, E, 2 (ASCII) 11: 8, O, 2 (ASCII) 12: 8, N, 1 (RTU) 13: 8, N, 2 (RTU) 14: 8, E, 1 (RTU) 15: 8, O, 1 (RTU) 16: 8, E, 2 (RTU) 17: 8, O, 2 (RTU)	♦R/W	0904	42309	15	
P09.09	Communication response delay time	0.0–200.0 ms	♦R/W	0909	42314	2.0	
P09.10	Communication main frequency	0.00–599.00 Hz	R/W	090A	42315	60.00	
P09.11	Block transfer 1	0–65535	♦R/W	090B	42316	0	
P09.12	Block transfer 2	0–65535	♦R/W	090C	42317	0	
P09.13	Block transfer 3	0–65535	♦R/W	090D	42318	0	
P09.14	Block transfer 4	0–65535	♦R/W	090E	42319	0	
P09.15	Block transfer 5	0–65535	♦R/W	090F	42320	0	
P09.16	Block transfer 6	0–65535	♦R/W	0910	42321	0	
P09.17	Block transfer 7	0–65535	♦R/W	0911	42322	0	
P09.18	Block transfer 8	0–65535	♦R/W	0912	42323	0	
P09.19	Block transfer 9	0–65535	♦R/W	0913	42324	0	
P09.20	Block transfer 10	0–65535	♦R/W	0914	42325	0	
P09.21	Block transfer 11	0–65535	♦R/W	0915	42326	0	
P09.22	Block transfer 12	0–65535	♦R/W	0916	42327	0	
P09.23	Block transfer 13	0–65535	♦R/W	0917	42328	0	
P09.24	Block transfer 14	0–65535	♦R/W	0918	42329	0	
P09.25	Block transfer 15	0–65535	♦R/W	0919	42330	0	
P09.26	Block transfer 16	0–65535	♦R/W	091A	42331	0	
P09.30	Communication decoding method	0: Decoding method 1 1: Decoding method 2	R/W	091E	42335	0	

GS20(X) Parameters Summary – Communication Parameters (P09.xx) – (continued)							
Parameter		Range	Run* Read/ Write	Modbus Address		Settings	
				Hex	Dec	Default	User
P09.33	PLC command force to 0	0–65535	◆R/W	0921	42338	0	
P09.35	PLC address	1–254	R/W	0923	42340	2	
P09.60	Communication card identification	0: No communication card 4: Modbus-TCP slave 5: EtherNet/IP slave 10: Backup power supply	Read	093C	42365	0	
P09.61	Firmware version of communication card	Read only (Hex format)	Read	093D	42366	0	
P09.62	Product code	Read only	Read	093E	42367	0	
P09.63	Error code	Read only	Read	093F	42368	0	
P09.74	Set Comm Master Protocol	0: Ethernet IP and Modbus TCP both 1: Ethernet IP 2: Modbus TCP	◆R/W	094A	42379	1	
P09.75	Communication card IP configuration (Ethernet)	0: Static IP 1: Dynamic IP (DHCP)	◆R/W	094B	42380	0	
P09.76	Communication card IP address 1 (Ethernet)	0–255	◆R/W	094C	42381	0	
P09.77	Communication card IP address 2 (Ethernet)	0–255	◆R/W	094D	42382	0	
P09.78	Communication card IP address 3 (Ethernet)	0–255	◆R/W	094E	42383	0	
P09.79	Communication card IP address 4 (Ethernet)	0–255	◆R/W	094F	42384	0	
P09.80	Communication card address mask 1 (Ethernet)	0–255	◆R/W	0950	42385	0	
P09.81	Communication card address mask 2 (Ethernet)	0–255	◆R/W	0951	42386	0	
P09.82	Communication card address mask 3 (Ethernet)	0–255	◆R/W	0952	42387	0	
P09.83	Communication card address mask 4 (Ethernet)	0–255	◆R/W	0953	42388	0	
P09.84	Communication card gateway address 1 (Ethernet)	0–255	◆R/W	0954	42389	0	
P09.85	Communication card gateway address 2 (Ethernet)	0–255	◆R/W	0955	42390	0	
P09.86	Communication card gateway address 3 (Ethernet)	0–255	◆R/W	0956	42391	0	
P09.87	Communication card gateway address 4 (Ethernet)	0–255	◆R/W	0957	42392	0	
P09.88	Communication card password (low word) (Ethernet)	0–99	◆R/W	0958	42393	0	
P09.89	Communication card password (high word) (Ethernet)	0–99	◆R/W	0959	42394	0	
P09.90	Reset communication card (Ethernet)	0: Disable 1: Reset to defaults	◆R/W	095A	42395	0	

GS20(X) Parameters Summary – Communication Parameters (P09.xx) – (continued)							
Parameter		Range	Run* Read/ Write	Modbus Address		Settings	
				Hex	Dec	Default	User
P09.91	Additional settings for the communication card (Ethernet)	bit 0: Enable IP filter bit 1: Enable internet parameters (1 bit) When the IP address is set, this bit is enabled. After updating the parameters for the communication card, this bit changes to disabled. bit 2: Enable login password (1 bit) When you enter the login password, this bit is enabled. After updating the communication card parameters, this bit changes to disabled.	◆R/W	095B	42396	0	
P09.92	Communication card status (Ethernet)	bit 0: Enable password When the communication card is set with a password, this bit is enabled. When the password is cleared, this bit is disabled.	R/W	095C	42397	0	
P09.93	ENETIP Comm Card Fault Select	0: Warn & Continue Operation 1: Warn & Ramp to Stop 2: Warn & Coast to Stop 3: No Warning & Continue Operation	◆R/W	095D	42398	3	
P09.94	ENETIP Comm Card Time Out Detection	0: Disable 1: Enable	◆R/W	095E	42399	1	
P09.95	ENETIP Comm Card Time Out Duration	0.1 to 100.0 seconds	◆R/W	095F	42400	3.0	

SPEED FEEDBACK CONTROL PARAMETERS SUMMARY (P10.xx)

For detailed information about the P10.xx parameter group, please refer to [page 4–220](#).

GS20(X) Parameters Summary – Speed Feedback Control Parameters (P10.xx)							
Parameter	Range	Run ¹⁾ Read/ Write	Modbus Address		Settings		
			Hex	Dec	Default ²⁾	User	
1) ♦ in the Run-Read/Write column indicates that the parameter can be set during RUN mode. R/W indicates "Read/Write." Read indicates "Read-only."							
2) Parameters can be restored to their <u>default values</u> using P00.02.							
P10.00	Encoder type selection	0: Disabled 5: Pulse input (DI7)	R/W	0A00	42561	0	
P10.01	Encoder pulses per revolution	1–20000	R/W	0A01	42562	600	
P10.02	Encoder input type setting	0: Disable 5: Single-phase input (DI7)	R/W	0A02	42563	0	
P10.04	Electrical gear at load side A1	1–65535	♦R/W	0A04	42565	100	
P10.05	Electrical gear at motor side B1	1–65535	♦R/W	0A05	42566	100	
P10.06	Electrical gear at load side A2	1–65535	♦R/W	0A06	42567	100	
P10.07	Electrical gear at motor side B2	1–65535	♦R/W	0A07	42568	100	
P10.10	Encoder stall level	0: No function 0–120%	♦R/W	0A0A	42571	115	
P10.11	Detection time of encoder stall	0.0–2.0 sec.	♦R/W	0A0B	42572	0.1	
P10.12	Encoder stall action	0: Warn and continue operation 1: Fault and ramp to stop 2: Fault and coast to stop	♦R/W	0A0C	42573	2	
P10.13	Encoder slip range	0: Disable 0–50%	♦R/W	0A0D	42574	50	
P10.14	Detection time of encoder slip	0.0–10.0 sec.	♦R/W	0A0E	42575	0.5	
P10.15	Encoder stall and slip error action	0: Warn and continue operation 1: Fault and ramp to stop 2: Fault and coast to stop	♦R/W	0A0F	42576	2	
P10.16	Pulse input type setting	0: Disabled 5: Single-phase input (DI7)	♦R/W	0A10	42577	0	
P10.17	Electrical gear A	1–65535	♦R/W	0A11	42578	100	
P10.18	Electrical gear B	1–65535	♦R/W	0A12	42579	100	
P10.21	PG2 (DI7) pulse input speed command low pass filter time	0.000–65.535 sec.	♦R/W	0A15	42582	0.100	
P10.24	FOC & TQC function control	0–65535	♦R/W	0A18	42585	0	
P10.25	FOC bandwidth for speed observer	20.0–100.0 Hz	♦R/W	0A19	42586	40.0	
P10.26	FOC minimum stator frequency	0.0–10.0% fN	♦R/W	0A1A	42587	2.0	
P10.27	FOC low pass filter time constant	1–1000 ms	♦R/W	0A1B	42588	50	
P10.28	FOC gain for excitation current rise time	33–100% Tr	♦R/W	0A1C	42589	100	
P10.29	Upper limit of frequency deviation	0.00–200.00 Hz	♦R/W	0A1D	42590	20.00	
P10.31	I/F mode, current command	0–150% rated current of the motor	♦R/W	0A1F	42592	40	
P10.32	PM sensorless speed estimator bandwidth	0.00–600.00 Hz	♦R/W	0A20	42593	5.00	

(table continued next page)

GS20(X) Parameters Summary – Speed Feedback Control Parameters (P10.xx) – (continued)							
Parameter		Range	Run* Read/ Write	Modbus Address		Settings	
				Hex	Dec	Default	User
P10.34	PM sensorless speed estimator low-pass filter gain	0.00–655.35	◆R/W	0A22	42595	1.00	
P10.35	Active Magnetic Regulator (AMR) (Kp) gain	0.00–3.00	◆R/W	0A23	42596	1.00	
P10.36	Active Magnetic Regulator (AMR) (Ki) gain	0.00–3.00	◆R/W	0A24	42597	0.20	
P10.39	Frequency point to switch from I/F mode to PM sensorless mode	0.00–599.00 Hz	◆R/W	0A27	42600	20.00	
P10.42	Initial angle detection pulse value	0.0–3.0	◆R/W	0A2A	42603	1.0	
P10.49	Zero voltage time during start-up	0.000–60.000 sec.	◆R/W	0A31	42610	0.000	
P10.51	Injection frequency	0–1200 Hz	◆R/W	0A33	42612	500	
P10.52	Injection magnitude	120V / 230V models: 100.0 V 460V models: 200.0 V 575V models: 200.0 V Note: The setting range varies depending on the voltage.	◆R/W	0A34	42613	15.0 30.0 37.5	
P10.53	Angle detection method	0: Disabled 1: Force attracting the rotor to zero degrees 2: High frequency injection 3: Pulse injection	◆R/W	0A35	42614	0	

ADVANCED PARAMETERS SUMMARY (P11.xx)

For detailed information about the P11.xx parameter group, please refer to [page 4-229](#).

GS20(X) Parameters Summary – Advanced Parameters (P11.xx)							
Parameter	Range	Run ¹⁾ Read/ Write	Modbus Address		Settings		User
			Hex	Dec	Default ²⁾		
1) ♦ in the Run-Read/Write column indicates that the parameter can be set during RUN mode. R/W indicates "Read/Write." Read indicates "Read-only."							
2) Parameters can be restored to their <u>default values</u> using P00.02.							
P11.00	System control	bit 0: Auto-tuning for ASR bit 3: Dead time compensation closed bit 7: Save or do not save the frequency	R/W	0B00	42817	0	
P11.01	Per-unit of system inertia	1–65535 (256 = 1 PU)	R/W	0B01	42818	256	
P11.02	ASR1/ASR2 switch frequency	5.00–599.00 Hz	♦R/W	0B02	42819	7.00	
P11.03	ASR1 low-speed bandwidth	1–40 Hz	Read	0B03	42820	0	
P11.04	ASR2 high-speed bandwidth	1–40 Hz	Read	0B04	42821	0	
P11.05	Zero-speed bandwidth	1–40 Hz	Read	0B05	42822	0	
P11.06	ASR1 (Kp) gain	0–40 Hz	♦R/W	0B06	42823	10	
P11.07	ASR1 (Ki) integral time	0.000–10.000 sec.	♦R/W	0B07	42824	0.100	
P11.08	ASR2 (Kp) gain	0–40 Hz	♦R/W	0B08	42825	10	
P11.09	ASR2 (Ki) integral time	0.000–10.000 sec.	♦R/W	0B09	42826	0.100	
P11.10	ASR Kp gain of zero speed	0–40 Hz	♦R/W	0B0A	42827	10	
P11.11	ASR (Ki) integral time of zero speed	0.000–10.000 sec.	♦R/W	0B0B	42828	0.100	
P11.12	Gain for ASR speed feed forward	0–200%	♦R/W	0B0C	42829	0	
P11.13	PDFF gain value	0–200%	♦R/W	0B0D	42830	30	
P11.14	ASR output low pass filter time	0.000–0.350 sec.	♦R/W	0B0E	42831	0.008	
P11.15	Notch filter depth	0–20 db	♦R/W	0B0F	42832	0	
P11.16	Notch filter frequency	0.00–200.00 Hz	♦R/W	0B10	42833	0.00	
P11.17	Forward motor torque limit	0–500%	♦R/W	0B11	42834	500	
P11.18	Forward regenerative torque limit	0–500%	♦R/W	0B12	42835	500	
P11.19	Reverse motor torque limit	0–500%	♦R/W	0B13	42836	500	
P11.20	Reverse regenerative torque limit	0–500%	♦R/W	0B14	42837	500	
P11.21	Flux weakening curve for motor 1 gain value	0–200%	♦R/W	0B15	42838	90	
P11.22	Flux weakening curve for motor 2 gain value	0–200%	♦R/W	0B16	42839	90	
P11.23	Flux weakening area speed response	0–150%	♦R/W	0B17	42840	65	
P11.27	Maximum torque command	0–500%	♦R/W	0B1B	42844	100	
P11.28	Torque offset source	0: Disable 1: Analog signal input 2: RS-485 communication (P11.29) 3: Controlled through external terminals (P11.30–P11.32)	♦R/W	0B1C	42845	0	
P11.29	Torque offset setting	-100.0–100.0%	♦R/W	0B1D	42846	0.0	
P11.30	High torque offset	-100.0–100.0%	♦R/W	0B1E	42847	30.0	
P11.31	Middle torque offset	-100.0–100.0%	♦R/W	0B1F	42848	20.0	

GS20(X) Parameters Summary – Advanced Parameters (P11.xx) – (continued)							
Parameter		Range	Run* Read/ Write	Modbus Address		Settings	
				Hex	Dec	Default	User
P11.32	Low torque offset	-100.0–100.0%	◆R/W	0B20	42849	10.0	
P11.33	Torque command source	0: Digital keypad 1: RS-485 communication (P11.34) 2: Analog signal input (P03.00) 5: Communication Card	◆R/W	0B21	42850	0	
P11.34	Torque command	-100.0–100.0%	◆R/W	0B22	42851	0.0	
P11.35	Torque command filter time	0.000–1.000 sec.	◆R/W	0B23	42852	0.000	
P11.36	Speed limit selection	0: Set by P11.37 (forward speed limit) and P11.38 (reverse speed limit) 1: Set by P00.20 (Master frequency command (AUTO, REMOTE) source) and P11.37, P11.38 2: Set by P00.20 (master frequency command (AUTO, REMOTE) source)	R/W	0B24	42853	0	
P11.37	Forward speed limit (Torque mode)	0–120%	◆R/W	0B25	42854	10	
P11.38	Reverse speed limit (Torque mode)	0–120%	◆R/W	0B26	42855	10	
P11.41	PWM mode selection	0: Two-phase modulation mode 2: Space vector modulation mode	R/W	0B29	42858	2	
P11.42	System control flag	0000–FFFFh	◆R/W	0B2A	42859	0000	

MACRO / USER DEFINED MACRO PARAMETERS SUMMARY (P13.xx)

For detailed information about the P13.xx parameter group, please refer to [page 4-238](#).

GS20(X) Parameters Summary – Macro / User-Defined Macro Parameters (P13.xx)							
Parameter	Range	Run ¹⁾ Read/ Write	Modbus Address		Settings		
			Hex	Dec	Default ²⁾	User	
1) ♦ in the Run-Read/Write column indicates that the parameter can be set during RUN mode. R/W indicates "Read/Write." Read indicates "Read-only."							
2) Parameters can be restored to their <u>default values</u> using P00.02.							
P13.00	Industry-specific parameter application	00: Disabled 01: User-defined parameter 02: Compressor 03: Fan 04: Pump 05: Conveyor 06: Machine tool 07: Packing 08: Textiles 10: Logistics 11: Tension PID 12: Tension PID + master / auxiliary frequency	R/W	0D0D	43329	00	
P13.01	User-defined parameter			0D01	43330		
P13.02	User-defined parameter			0D02	43331		
P13.03	User-defined parameter			0D03	43332		
P13.04	User-defined parameter			0D04	43333		
P13.05	User-defined parameter			0D05	43334		
P13.06	User-defined parameter			0D06	43335		
P13.07	User-defined parameter			0D07	43336		
P13.08	User-defined parameter			0D08	43337		
P13.09	User-defined parameter			0D09	43338		
P13.10	User-defined parameter			0D0A	43339		
P13.11	User-defined parameter			0D0B	43340		
P13.12	User-defined parameter			0D0C	43341		
P13.13	User-defined parameter			0D0D	43342		
P13.14	User-defined parameter			0D0E	43343		
P13.15	User-defined parameter			0D0F	43344		
P13.16	User-defined parameter			0D10	43345		
P13.17	User-defined parameter			0D11	43346		
P13.18	User-defined parameter			0D12	43347		
P13.19	User-defined parameter			0D13	43348		
P13.20	User-defined parameter			0D14	43349		
P13.21	User-defined parameter			0D15	43350		
P13.22	User-defined parameter			0D16	43351		
P13.23	User-defined parameter			0D17	43352		
P13.24	User-defined parameter			0D18	43353		
P13.25	User-defined parameter			0D19	43354		
P13.26	User-defined parameter			0D1A	43355		
P13.27	User-defined parameter			0D1B	43356		
P13.28	User-defined parameter			0D1C	43357		
P13.29	User-defined parameter			0D1D	43358		
P13.30	User-defined parameter			0D1E	43359		
P13.31	User-defined parameter			0D1F	43360		
P13.32	User-defined parameter			0D20	43361		
P13.33	User-defined parameter			0D21	43362		
P13.34	User-defined parameter			0D22	43363		

GS20(X) Parameters Summary – Macro / User-Defined Macro Parameters (P13.xx) – (continued)							
Parameter		Range	Run* Read/ Write	Modbus Address		Settings	
				Hex	Dec	Default	User
P13.35	User-defined parameter			0D23	43364		
P13.36	User-defined parameter			0D24	43365		
P13.37	User-defined parameter			0D25	43366		
P13.38	User-defined parameter			0D26	43367		
P13.39	User-defined parameter			0D27	43368		
P13.40	User-defined parameter			0D28	43369		
P13.41	User-defined parameter			0D29	43370		
P13.42	User-defined parameter			0D2A	43371		
P13.43	User-defined parameter			0D2B	43372		
P13.44	User-defined parameter			0D2C	43373		
P13.45	User-defined parameter			0D2D	43374		
P13.46	User-defined parameter			0D2E	43375		
P13.47	User-defined parameter			0D2F	43376		
P13.48	User-defined parameter			0D30	43377		
P13.49	User-defined parameter			0D31	43378		
P13.50	User-defined parameter			0D32	43379		

PROTECTION PARAMETERS (2) SUMMARY (P14.xx)

For detailed information about the P14.xx parameter group, please refer to [page 4–251](#).

GS20(X) Parameters Summary – Protection Parameters (2) (P14.xx)							
Parameter	Range	Run ¹⁾ Read/ Write	Modbus Address		Settings		
			Hex	Dec	Default ²⁾	User	
1) ♦ in the Run-Read/Write column indicates that the parameter can be set during RUN mode. R/W indicates "Read/Write." Read indicates "Read-only."							
2) Parameters can be restored to their <u>default values</u> using P00.02.							
P14.50	Output frequency at malfunction 2	0.00–599.00 Hz	Read	0E32	43635	0	
P14.51	DC bus voltage at malfunction 2	0.0–6553.5 V	Read	0E33	43636	0	
P14.52	Output current at malfunction 2	0.00–655.35 Amp	Read	0E34	43637	0	
P14.53	IGBT temperature at malfunction 2	-3276.7–3276.7°C	Read	0E35	43638	0	
P14.54	Output frequency at malfunction 3	0.00–599.00 Hz	Read	0E36	43639	0	
P14.55	DC bus voltage at malfunction 3	0.0–6553.5 V	Read	0E37	43640	0	
P14.56	Output current at malfunction 3	0.00–655.35 Amp	Read	0E38	43641	0	
P14.57	IGBT temperature at malfunction 3	-3276.7–3276.7°C	Read	0E39	43642	0	
P14.58	Output frequency at malfunction 4	0.00–599.00 Hz	Read	0E3A	43643	0	
P14.59	DC bus voltage at malfunction 4	0.0–6553.5 V	Read	0E3B	43644	0	
P14.60	Output current at malfunction 4	0.00–655.35 Amp	Read	0E3C	43645	0	
P14.61	IGBT temperature at malfunction 4	-3276.7–3276.7°C	Read	0E3D	43646	0	
P14.62	Output frequency at malfunction 5	0.00–599.00 Hz	Read	0E3E	43647	0	
P14.63	DC bus voltage at malfunction 5	0.0–6553.5 V	Read	0E3F	43648	0	
P14.64	Output current at malfunction 5	0.00–655.35 Amp	Read	0E40	43649	0	
P14.65	IGBT temperature at malfunction 5	-3276.7–3276.7°C	Read	0E41	43650	0	
P14.66	Output frequency at malfunction 6	0.00–599.00 Hz	Read	0E42	43651	0	
P14.67	DC bus voltage at malfunction 6	0.0–6553.5 V	Read	0E43	43652	0	
P14.68	Output current at malfunction 6	0.00–655.35 Amp	Read	0E44	43653	0	
P14.69	IGBT temperature at malfunction 6	-3276.7–3276.7°C	Read	0E45	43654	0	
P14.70	Fault record 7	Refer to fault record P06.17–P06.22	Read	0E46	43655	0	
P14.71	Fault record 8	Refer to fault record P06.17–P06.22	Read	0E47	43656	0	
P14.72	Fault record 9	Refer to fault record P06.17–P06.22	Read	0E48	43657	0	
P14.73	Fault record 10	Refer to fault record P06.17–P06.22	Read	0E49	43658	0	

GS20(X) Parameters Summary – Protection Parameters (2) (P14.xx) – (continued)							
Parameter		Range	Run* Read/ Write	Modbus Address		Settings	
				Hex	Dec	Default	User
P14.74	Over-torque detection selection (motor 3)	0: No function 1: Continue operation after over-torque detection during constant speed operation 2: Stop after over-torque detection during constant speed operation 3: Continue operation after over-torque detection during RUN 4: Stop after over-torque detection during RUN	◆R/W	0E4A	43659	0	
P14.75	Over-torque detection level (motor 3)	10–250% (100% corresponds to the rated current of the drive)	◆R/W	0E4B	43660	120	
P14.76	Over-torque detection time (motor 3)	0.1–60.0 sec.	◆R/W	0E4C	43661	0.1	
P14.77	Over-torque detection selection (motor 4)	0: No function 1: Continue operation after over-torque detection during constant speed operation 2: Stop after over-torque detection during constant speed operation 3: Continue operation after over-torque detection during RUN 4: Stop after over-torque detection during RUN	◆R/W	0E4D	43662	0	
P14.78	Over-torque detection level (motor 4)	10–250% (100% corresponds the rated current of the drive)	◆R/W	0E4E	43663	120	
P14.79	Over-torque detection time (motor 4)	0.1–60.0 sec.	◆R/W	0E4F	43664	0.1	
P14.80	Electronic thermal relay selection 3 (motor 3)	0: Inverter motor (with external forced cooling) 1: Standard motor (motor with the fan on the shaft) 2: Disable	◆R/W	0E50	43665	2	
P14.81	Electronic thermal relay action time 3 (motor 3)	30.0–600.0 sec.	◆R/W	0E51	43666	60.0	
P14.82	Electronic thermal relay selection 4 (motor 4)	0: Inverter motor (with external forced cooling) 1: Standard motor (motor with the fan on the shaft) 2: Disable	◆R/W	0E52	43667	2	
P14.83	Electronic thermal relay action time 4 (motor 4)	30.0–600.0 sec.	◆R/W	0E53	43668	60.0	



NOTE: For Command and Status addresses (2000h-2200h), refer to page 4-210.

DURAPULSE GS20(X) PARAMETER DETAILS

EXPLANATION OF PARAMETER DETAILS FORMAT

<u>Pxx.xx</u>	<u>Descriptive Parameter Name</u>	<u>Type</u>	<u>Hex Addr</u>	<u>Dec Addr</u>
	<u>Range/Units</u>	◆R/W	xxxx	4xxxx
	xx~xxx.xx	<u>Default</u>		
		xx		

Where:

- Pxx.xx = Parameter number, followed by descriptive parameter name
- Type = Parameter type (◆R/W)
 - ◆ = Parameter can be set while drive is in run mode
 - R/W = Read/Write parameter
 - Read = Read-only; parameter can be read from, but not written to
- Hex Addr = Hexadecimal parameter address
- Dec Addr = Modbus decimal parameter address
- Range/Units = Range of parameter settings, including units if applicable
- Default = Parameter default setting
(Parameters can be restored to their default values using P00.02.)

GROUP P00.xx DETAILS – DRIVE PARAMETERS

	<i>Type</i>	<i>Hex Addr</i>	<i>Dec Addr</i>
P00.00 GS20(X) Model ID	Read	0000	40001
<i>Range/Units (Format: 16-bit unsigned)</i>	<i>Default</i>		
102: 120 V, 1 Phase, 0.25 HP	0		
103: 120 V, 1 Phase, 0.5 HP			
104: 120 V, 1 Phase, 1 HP			
302: 230 V, 1 Phase, 0.25 HP			
303: 230 V, 1 Phase, 0.5 HP			
304: 230 V, 1 Phase, 1 HP			
305: 230 V, 1 Phase, 2 HP			
306: 230 V, 1 Phase, 3 HP			
202: 230 V, 3 Phase, 0.25 HP			
203: 230 V, 3 Phase, 0.5 HP			
204: 230 V, 3 Phase, 1 HP			
205: 230 V, 3 Phase, 2 HP			
206: 230 V, 3 Phase, 3 HP			
207: 230 V, 3 Phase, 5 HP			
208: 230 V, 3 Phase, 7.5 HP			
209: 230 V, 3 Phase, 10 HP			
210: 230 V, 3 Phase, 15 HP			
211: 230 V, 3 Phase, 20 HP			
403: 460 V, 3 Phase, 0.5 HP			
404: 460 V, 3 Phase, 1 HP			
405: 460 V, 3 Phase, 2 HP			
406: 460 V, 3 Phase, 3 HP			
407: 460 V, 3 Phase, 5 HP			
408: 460 V, 3 Phase, 7.5 HP			
409: 460 V, 3 Phase, 10 HP			
410: 460 V, 3 Phase, 15 HP			
411: 460 V, 3 Phase, 20 HP			
412: 460 V, 3 Phase, 25 HP			
413: 460 V, 3 Phase, 30 HP			
504: 575 V, 3 Phase, 1 HP			
505: 575 V, 3 Phase, 2 HP			
506: 575 V, 3 Phase, 3 HP			
507: 575 V, 3 Phase, 5 HP			
508: 575 V, 3 Phase, 7.5 HP			
509: 575 V, 3 Phase, 10 HP			

P00.00 displays a code that corresponds to the voltage, phase, and horsepower rating of the GS20(X) drive.

	<i>Type</i>	<i>Hex Addr</i>	<i>Dec Addr</i>
P00.01 GS20 Drive Rated Amps	Read	0001	40002
<i>Range/Units (Format: 16-bit unsigned)</i>	<i>Default</i>		
Display by models	0		

P00.01 displays rated current in amps for the drive. By default this displays the value for constant torque. Set P00.16=0 to display the variable torque rating instead.

P00.02	Restore to Default	<i>Type</i>	<i>Hex Addr</i>	<i>Dec Addr</i>
	<i>Range/Units (Format: 16-bit binary)</i>	R/W	0002	40003
		<i>Default</i>		
	0: No function	0		
	1: Parameter Lock			
	2: Enter GS2 Mode (Step 1 of 2)			
	5: Reset kWh Display to 0			
	6: Reset PLC			
	7: No function			
	8: Disable Keypad Run			
	9: Reset all parameters to 50Hz defaults			
	10: Reset all parameters to 60Hz defaults			
	11: Reset all parameters to 50Hz defaults (retain user-defined parameter values P13.01~P13.50)			
	12: Reset all parameters to 60Hz defaults (retain user-defined parameter values P13.01~P13.50)			
	20: Enter GS2 Mode (Step 2 of 2)			

P00.02 allows the resetting of various parameter sets and drive functions.

Setting Explanations

- P00.02=1, all parameters are set to read only except for P00.02, P00.07, and P00.08. P00.02 must be changed to 0 to change parameter settings.
- P00.02=5, returns the kWh displayed value to 0, even during drive operation. For example, P05.26 accumulated W-s will be set to zero.
- P00.02=6, clears the internal PLC program.
- P00.02=8, disables the RUN key on the drive keypad.
- P00.02=9, resets all parameters to default for base frequency of 50Hz.
- P00.02=10, resets all parameters to default for base frequency of 60Hz.
- P00.02=11, resets all parameters to default for base frequency of 50Hz, but keeps any user-defined parameter values (P13.01 through P13.50).
- P00.02=12, resets all parameters to default for base frequency of 60Hz, but keeps any user-defined parameter values (P13.01 through P13.50).
- If a password has been set using P00.08, you must unlock and clear the password (P00.07) before resetting parameters.



NOTE: For settings 6, 9, 10, 11, and 12 you must reboot the drive after adjusting the setting to enable the change.

- To convert the drive parameter set to GS2 Mode:

- Step 1 - P00.02 = 2
- Step 2 - P00.02 = 20

This sequence reverts the GS20 parameter set to the reduced parameter set of a GS2 drive. To revert back to GS20 mode after the drive is in GS2 mode, set P09.08 to 20 (see GS2 Mode appendix). All parameter values will reset to default with these actions.

P00.03	Start-up Display Selection	<i>Type</i>	<i>Hex Addr</i>	<i>Dec Addr</i>
		◆R/W	0003	40004
	<i>Range/Units (Format: 16-bit binary)</i>	<i>Default</i>		
	0: F – Freq Setpoint	0		
	1: H – Output Hz			
	2: U - User Display P00-04)			
	3: A – Output Amps			

P00.03 determines the start-up display page when the drive is powered on. The user-defined contents display according to the P00.04 settings.

	<i>Type</i>	<i>Hex Addr</i>	<i>Dec Addr</i>
P00.04 User Display	◆R/W	0004	40005
<i>Range/Units (Format: 16-bit binary)</i>	<i>Default</i>		
0: Output Amps (A) (unit: Amp)	3		
1: Counter Value (c) (unit: CNT)			
2: Output Frequency (H.) (unit: Hz)			
3: DC Bus Voltage (V) (unit: VDC)			
4: Output Voltage (E) (unit: VAC)			
5: Power Factor (n) (unit: deg)			
6: Output Power (P) (unit: kW)			
7: Calculated RPM (r) (unit: rpm)			
8: Est Output Torque (t) (unit: %)			
10: PID Feedback (b) (unit: %)			
11: AI1 Analog Input Signal (1.) (unit: %)			
12: AI2 Analog Input Signal (2.) (unit: %)			
14: IGBT Temperature (i.) (unit: °C)			
16: DI Input Status (ON / OFF) (i)			
17: DO Output Status (ON / OFF) (o)			
18: Multi-Speed Step (S)			
19: CPU DI Input Status (d)			
20: CPU DO Output Status (0.)			
22: Pulse input frequency (S.)			
25: Overload count (0.00–100.00%) (o.) (unit: %)			
26: Ground fault GFF (G.) (unit: %)			
27: DC bus voltage ripple (r.) (unit: VDC)			
28: Display PLC register D1043 data (C)			
30: Display the output of User-defined (U)			
31: Display P00.05 user gain (K)			
35: Control mode display:			
0 = Speed control mode (SPD) (t.)			
1 = Torque control mode (TQR) (t.)			
36: Present operating carrier frequency of the drive (J.) (Unit: Hz)			
38: Display the drive status (6.)			
39: Display the drive's estimated output torque, positive and negative, using Nt-m as unit (t 0.0: positive torque; -0.0: negative torque) (C.)			
40: Torque command (L.) (unit: %)			
41: kWh display (J) (unit: kWh)			
42: PID target value (h.) (unit: %)			
43: PID compensation (o.) (unit: %)			
44: PID output frequency (b.) (unit: Hz)			
46: Auxiliary frequency value (U.) (unit: Hz)			
47: Master frequency value (A.) (unit: Hz)			
48: Frequency value after addition and subtraction of master and auxiliary frequency (L.) (unit: Hz)			
51: PMSVC torque offset (t.)			
58: P00.05 User gain display (K) (Does not display decimal places.)			
62: I2t (o.) (unit: %)			
63: Error code (E.)			
64: Warning code (n.)			
65: Accumulated motor operation record (day) (r.) (refer to P05.32)			

P00.04 is used to configure the user display.

Explanation 1:

It can also display negative values when setting analog input bias (P03.03 to P03.10).

Example: Assume that AI1 input voltage is 0V, P03.03 is 10.0%, P03.07 is 4 (bias serves as center).

Explanation 2:

Example: If DI1 and DI2 are ON, the following table shows the status of the terminals.

Normally opened contact (N.O.): (0: OFF, 1:ON)

Terminal	DI7	DI6	DI5	DI4	DI3	DI2	DI1
Status	0	1	0	0	0	0	1

- The value is 0000 0000 0010 0001 in binary and 0021H in HEX. When P00.04 is set to 16 or 19, the User Defined Display on the keypad displays 0021h.
- Setting 16 is the ON/OFF status of digital input according to P02.12 setting, and setting 19 is the corresponding CPU pin ON/OFF status of the digital input.
- When DI1/DI2 default setting is two-wire/three-wire operation control (P02.00≠0) and DI3 is set to three-wire, it is not affected by P02.12.
- You can use setting 16 to monitor the digital input ON/OFF status, and then set 19 to check if the circuit is normal.

Explanation 3:

Example: Assume that RY:P02.13 is set to 9 (Drive is ready). After the drive is powered on, if there is no other abnormal status, the contact is ON. The display status is shown below:

Normally opened contact (N.O.):

Terminal	D02	D01	R1
Status	0	0	1

- If P00.04 is set to 17 or 20, it displays in hexadecimal "0001h" and the User Defined Display shows ON in the keypad.
- Setting 17 is the ON/OFF status of digital output according to P02.18 setting, and setting 20 is the corresponding CPU pin ON/OFF status of the digital output.
- You can use setting 17 to monitor the digital output ON/OFF status, and then set 20 to check if the circuit is normal.

Explanation 4:

For setting 8, 100% represents the motor’s rated torque.

$$\text{Motor rated torque} = (\text{motor rated power} \times 60/2\pi) / \text{motor rated speed}$$

Explanation 5:

For setting 25, when the displayed value reaches 100.00%, the drive shows “oL” as an overload warning.

Explanation 6:

When set to 38, the bits are defined as follows:

- Bit 0: The drive is running forward
- Bit 1: The drive is running backward
- Bit 2: The drive is ready
- Bit 3: Errors occurred on the drive
- Bit 4: The drive is running
- Bit 5: Warnings occurred on the drive

	Type	Hex Addr	Dec Addr
P00.05 Coefficient gain in actual output frequency	R/W	0005	40006
<i>Range/Units (Format: 16-bit unsigned)</i>	<i>Default</i>		
0.00–160.00	1.00		

P00.05 is used to set the user-defined coefficient gain. Set P00.04=31 to display the calculation result on the screen (calculation = output frequency x P00.05).

	Type	Hex Addr	Dec Addr
P00.06 Firmware Version	Read	0006	40007
<i>Range/Units (Format: 16-bit unsigned)</i>	<i>Default</i>		
Read only	0		

P00.06 displays the current firmware version of the drive. Also, check parameter 00.50 for FW date code. Minor updates may only increment a change in date code.

	Type	Hex Addr	Dec Addr
P00.07 Parameter Protection Password Input	◆R/W	0007	40008
<i>Range/Units (Format: 16-bit unsigned)</i>	<i>Default</i>		
0–65535	0		
0–4: the number of password attempts allowed			

P00.07 allows you to enter the password set via P00.08 to unlock parameter protection and make changes to parameters.

- P00.07 and P00.08 are used to prevent personnel from accidentally changing parameter values.
- When password protection is on, all parameters will read 0 except for P00.08.
- Incorrect passwords can be entered up to four times. Each time an incorrect password is entered, the keypad will display the number of incorrect attempts (01, 02, 03). When the final incorrect password is entered, the keypad will flash "Pcode" and the keypad will lock. To re-activate the keypad, reboot the drive and either enter the correct password or reset it.
- To reset a forgotten password, input 9999 and press ENTER, then input 9999 again and press ENTER again within 10 seconds. All settings will return to default.

	Type	Hex Addr	Dec Addr
P00.08 Parameter Protection Password Setting	◆R/W	0008	40009
<i>Range/Units (Format: 16-bit unsigned)</i>	<i>Default</i>		
0–65535	0		
0: No password protection or password entered correctly (P00.07)			
1: Parameter has been set			

P00.08 allows you to set a password to protect parameter settings. If P00.08=1, password protection is active. If P00.08=0, password protection is disabled.

- To change parameters once a password has been set, you must enter the correct password using P00.07 which temporarily deactivates parameter protection and sets P00.08=0. Once parameter changes are complete, reboot the drive and P00.08 will reset to 1.
- To permanently disable the password, manually change P00.08 to 0. Otherwise, password protection is always reactivated after you reboot the motor drive.
- The keypad copy function works only when the password protection is deactivated (temporarily or permanently), and the password set in P00.08 cannot be copied to the keypad. So when copying parameters from the keypad to the motor drive, set the password manually again in the motor drive to activate password protection.

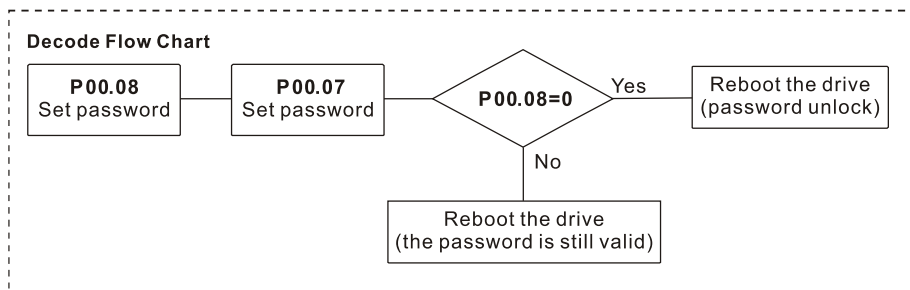
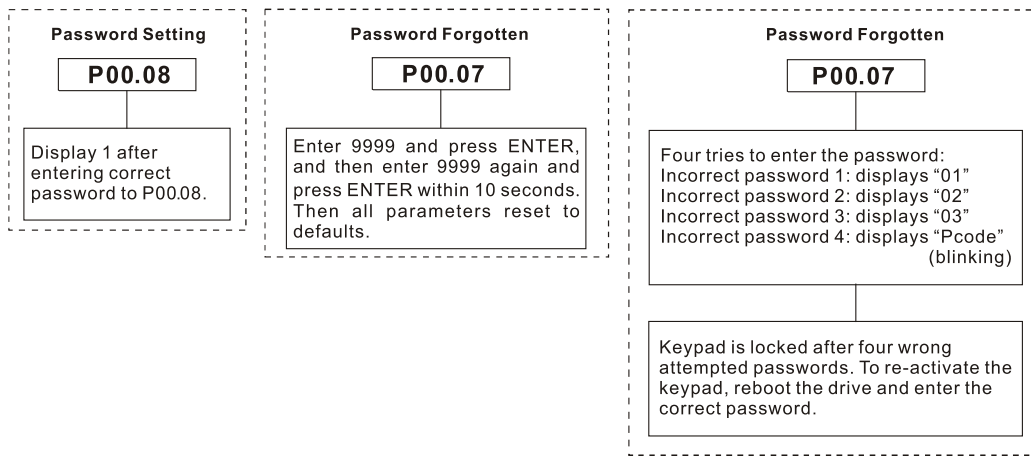

P00.10 Control Mode

Range/Units (Format: 16-bit binary)

- 0: Speed control mode
- 2: Torque mode (TQC Sensorless Mode)

Type	Hex Addr	Dec Addr
R/W	000A	40011
<u>Default</u>		0

P00.10 determines the control mode of the GS20(X) drive.

- If P00.10=0: Speed Control mode, use parameter P00.11 to set the specific speed control format.
- If P00.10=2: Torque mode, the drive is in TQC sensorless mode. P00.11 is not used. This mode supports induction motors only.

See Adjustments and Applications section on page 4–257 for further info on setting up this mode.

See the next page for the torque mode control diagram.

Torque mode control diagram:

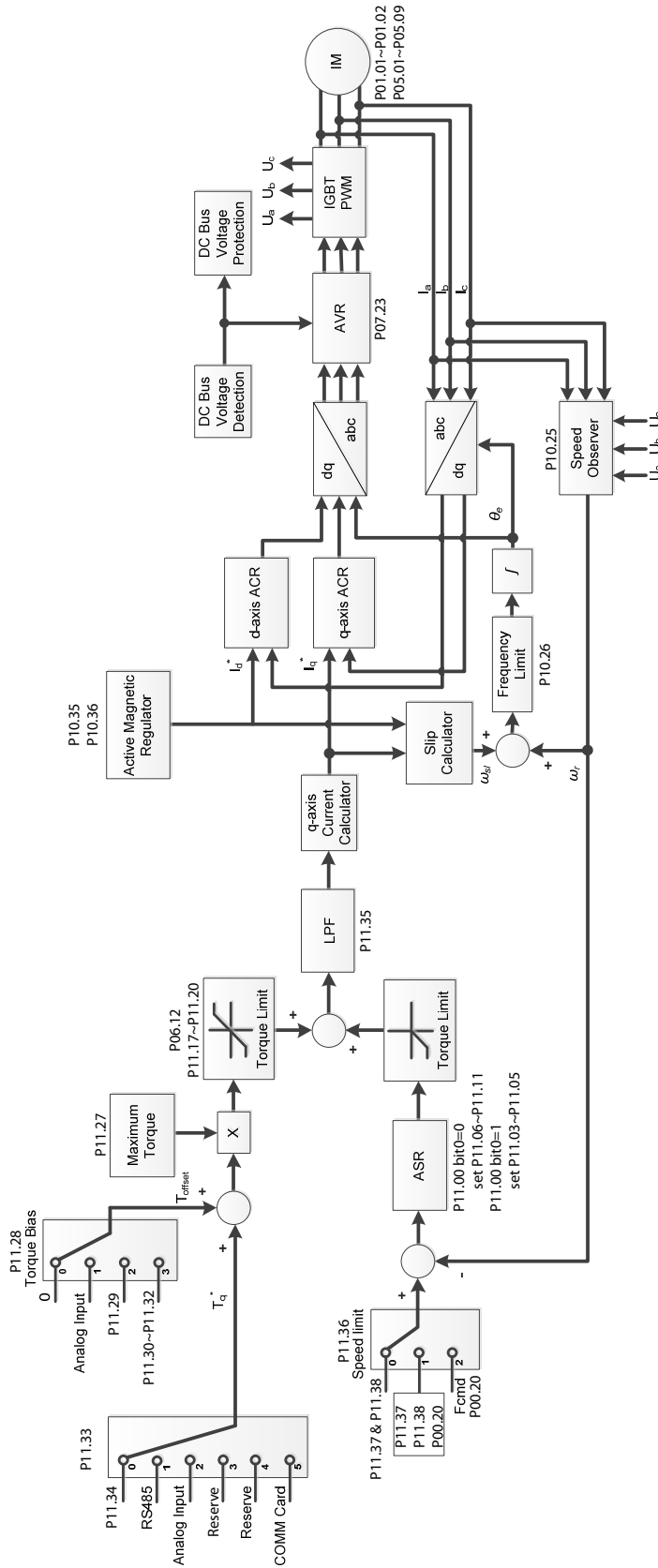

P00.11	Speed Control Mode	Type	Hex Addr	Dec Addr
		R/W	000B	40012
	<i>Range/Units (Format: 16-bit binary)</i>	<i>Default</i>		
	0: IMVF (IM V/F control)	0		
	1: IMVFPG (IM V/F control + encoder)			
	2: IM/PM SVC (IM / PM space vector control)			
	5: IMFOC Sensorless (IM field-oriented sensorless vector control)			

P00.11 determines the speed control mode of the GS20 drive.

P00.10 must be set to 0:Speed Control mode to enable this parameter.

Speed control abbreviations:

- IM = Induction Motor
- PM = Permanent Magnet Motor
- SVC = Sensorless Vector Control
- VF = Volt/Frequency
- PG = Pulse Generator (encoder)
- FOC = Field Oriented Control

Setting Explanations

- P00.11=0, drive is set to IM V/F control. You can configure the proportion of V/F as required and control multiple motors simultaneously.
- P00.11=1, drive is set to IM V/F control with Pulse Generator (PG) input (encoder). The encoder can be used for closed-loop speed control.
- P00.11=2, drive is set to IM/PM space vector control. This auto-tunes motor parameters for optimal control. This is the only control mode that supports permanent magnet motors (IPM or SPM). Set P05.33=1 or 2 for PM motors.
- P00.11=5, drive is set to IM FOC sensorless: IM field-oriented sensorless vector control. Field oriented control (FOC) provides the most precise vector control algorithm for induction motors. This control method can separately control the motor’s magnetic field and torque. When controlling the torque, the magnetic field won’t be interfered and quick feedback from torque wresults in more stable operation. With optimized current control, the maximum torque can be reached with the minimum current. The motor’s temperature will decrease and system efficiency will increase. FOC sensorless control is suitable for applications which require activation of torque at low frequency, quick feedback on speed chasing, and stable rotation speed and torque force.
- See Adjustments and Applications section on page 4–257 for further info on setting up various speed modes.

NOTE: If DI7 single-phase pulse input is used as speed feedback, the following settings must be used:



- P00.11 speed control mode must be set to 1:IMVFPG only
- P02.07 must be set to 0
- P10.00 and P10.02 must be set to 5

Control Diagrams

IM V/F Control (IMVF)

When P00.10=0 and P00.11 is set to 0:IMVF, the V/F control diagram is:

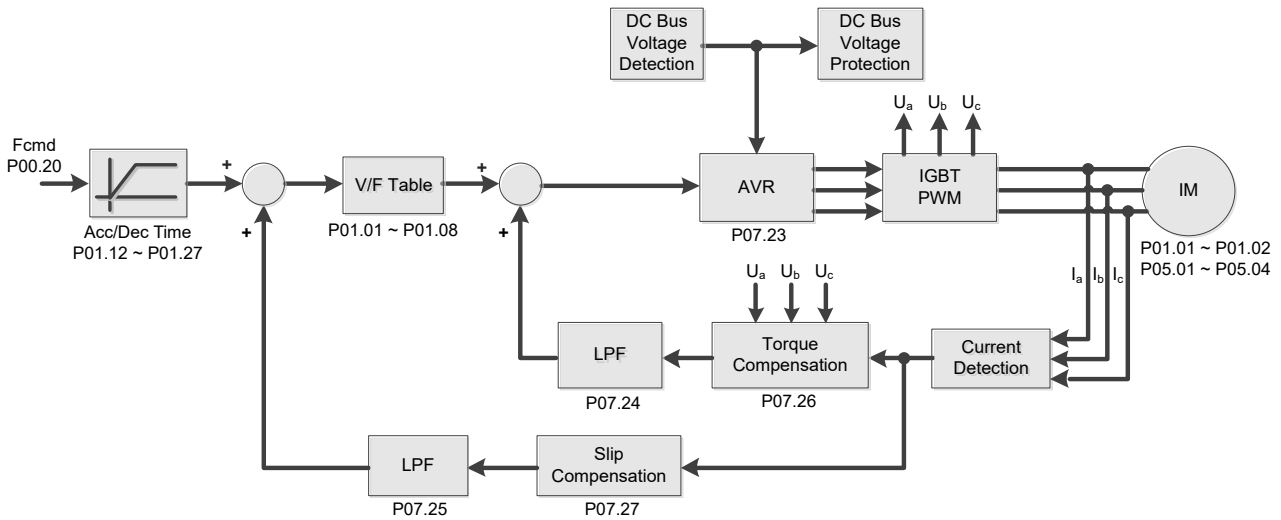

IM V/F control + encoder (IMVFPG)

When P00.10=0 and P00.11 is set to 1:IMVFPG, the V/F control + encoder diagram is:

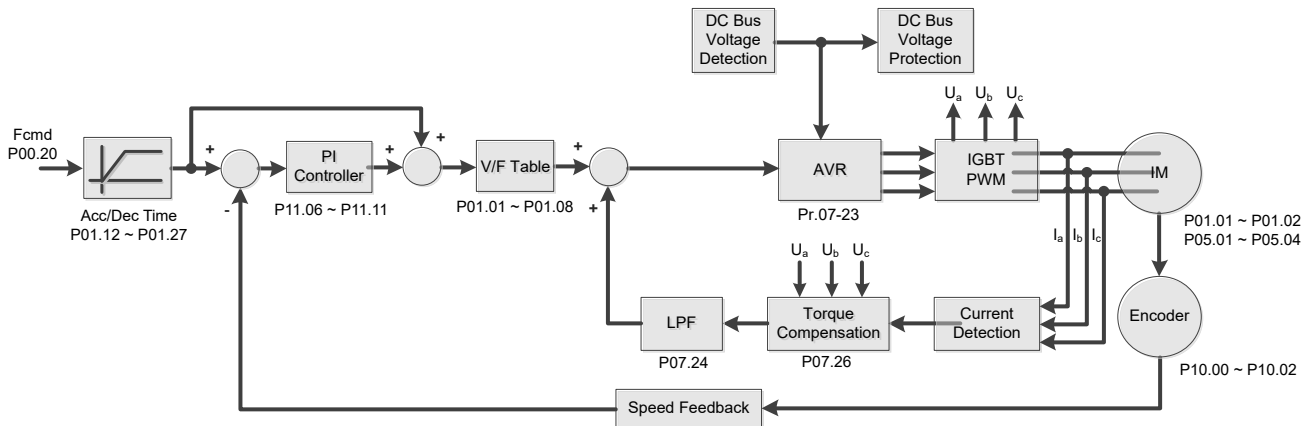

IM Space Vector Control (IMSVC)

When P00.10=0 and P00.11 is set to 2:IM/PM SVC for an IM motor (P05.33=0), the sensorless vector control diagram is:

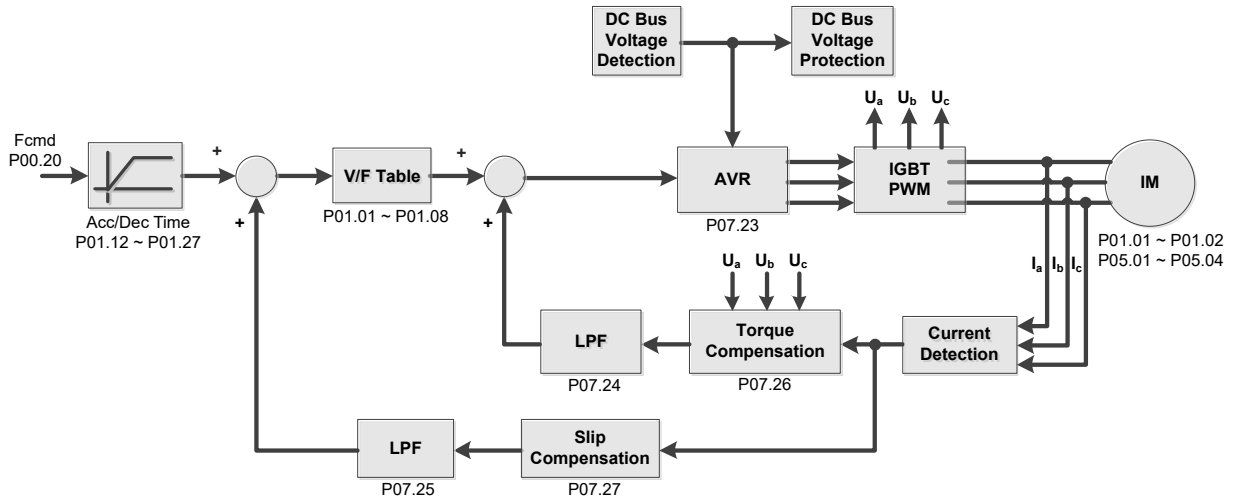

PM Space Vector Control (PMSVC)

When P00.10=0 and P00.11 is set to 2:IM/PM SVC for a PM motor (P05.33=1 or 2), the sensorless vector control diagram is:

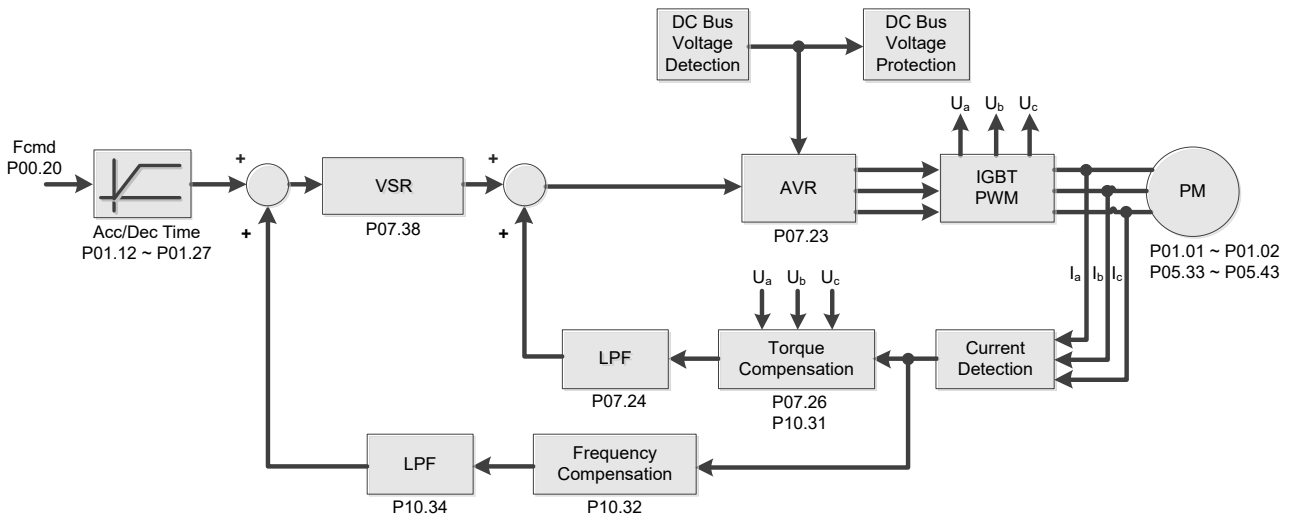

See Adjustments and Applications section on page 4-257 for further info on setting up this mode.

IMFOC Sensorless

When P00.10=0 and P00.11 is set to 5:IMFOC Sensorless, the IMFOC sensorless control diagram is:

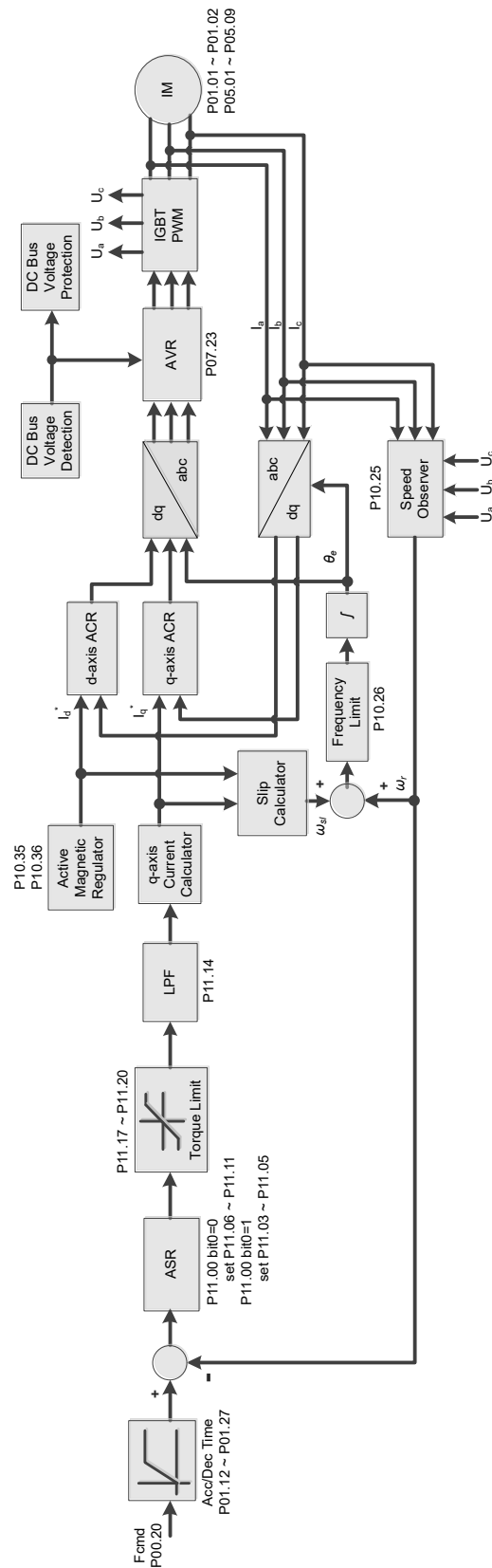

See Adjustments and Applications section on page 4–257 for further info on setting up this mode.

P00.16 Torque Duty Selection	Type	Hex Addr	Dec Addr
	R/W	0010	40017
<u>Range/Units (Format: 16-bit binary)</u>	<u>Default</u>		
0: Variable Torque	1		
1: Constant Torque			

P00.16 is used to configure the GS20(X) drive for variable torque or constant torque load.

- Variable Torque (VT): overload rated output current 150% in 3 seconds. (120%, 1 minute). Refer to P00.17 for the setting for the carrier frequency. Refer to Chapter 1 or P00.01 for the rated current.
- Constant Torque (CT): overload rated output current 200% in 3 seconds. (150%, 1 minute) Refer to P00.17 for the setting for the carrier frequency. Refer to Chapter 1 or P00.01 for the rated current.
- P00.01 varies with the set value of P00.16. The default value and maximum of P06.03 and P06.04 also vary with the value of P00.16.
- In VT mode, the default setting of P06.03 and P06.04 is 120%, and the maximum is 150%.
- In CT mode, the default setting of P06.03 and P06.04 is 180%, and the maximum is 200%.

P00.17 Carrier Frequency	Type	Hex Addr	Dec Addr
	R/W	0011	40018
<u>Range/Units (Format: 16-bit unsigned)</u>	<u>Default</u>		
VT: 2–15 kHz	4		
CT: 2–15 kHz			
Note: When P00.11=5 (IMFOC Sensorless), the maximum setting value for the carrier frequency is 10 kHz.			

P00.17 is used to set the PWM carrier frequency for the GS20(X) drive. Note that the maximum value is dependent on the horsepower and voltage ratings of the drive.

<u>Model</u>	<u>Range</u>
120V, 1/4–1 hp	2–15 kHz
230V, 1/4–15 hp	2–15 kHz
230V, 20–30 hp	2–10 kHz
460V, 1/2–20 hp	2–15 kHz
460V, 25–40 hp	2–10 kHz
575V, 1–10 hp	2–15 kHz

The table below shows that the PWM carrier frequency has significant influences on the electromagnetic noise, the AC motor drive heat dissipation, and the motor acoustic noise. Therefore, if the surrounding noise is greater than the motor noise, lower the carrier frequency to reduce the temperature rise. Although the motor has quiet operation in the higher carrier frequency, consider the entire wiring and interference.

Carrier Frequency	Acoustic Noise	Electromagnetic Noise or Leakage Current	Heat Dissipation	Current Wave
2 kHz	Significant ↑ ↓ Minimal	Minimal ↑ ↓ Significant	Minimal ↑ ↓ Significant	
8 kHz				
15 kHz				

When the carrier frequency is higher than the default, decrease the carrier frequency to protect the drive. Refer to P06.55 for the related setting and details.

	<u>Type</u>	<u>Hex Addr</u>	<u>Dec Addr</u>
P00.18 GS Series Number	Read	0012	40019
<u>Range/Units (Format: 16-bit binary)</u>	<u>Default</u>		
20: GS20 series drive (GS21 or GS23)	–		
21: GS20X series drive (GS21X or GS23X)			

GS drive series is a read only value that indicates whether the drive is a GS21/GS23 hardware model, GS21X/GS23X NEMA4X hardware model, or other Durapulse GS model drive.

	<u>Type</u>	<u>Hex Addr</u>	<u>Dec Addr</u>
P00.19 PLC Command Mask	Read	0013	40020
<u>Range/Units (Format: 16-bit binary)</u>	<u>Default</u>		
bit 0: Control command is forced by PLC control	0		
bit 1: Frequency command is forced by PLC control			
bit 3: Torque command is forced by PLC control			

P00.19 determines if the frequency command, control command or torque command is locked by PLC.

	<u>Type</u>	<u>Hex Addr</u>	<u>Dec Addr</u>
P00.20 Master Frequency Command Source (AUTO, REMOTE)	◆R/W	0014	40021
<u>Range/Units (Format: 16-bit binary)</u>	<u>Default</u>		
0: Digital keypad	0		
1: RS-485 communication input			
2: External analog input (Refer to P03.00)			
3: External UP / DOWN terminal (multi-function input terminals)			
4: Pulse Input (DI7) without direction command (refer to P10.16 without considering direction)			
6: No function			
7: Digital Keypad VR/Potentiometer Dial (GS20 only)			
8: Communication card			
9: PID controller			
Note: HOA (Hand-Off-Auto) function is valid only when you use with DI function setting 41/42 or 56 or with GS4-KPD (optional).			

P00.20 determines the master frequency source in the "AUTO, REMOTE" mode. The default is AUTO mode.

- You can switch the AUTO, REMOTE mode with the keypad GS4-KPD (optional) or the multi-function input terminal (DI) to set the master frequency source.
- The drive returns to AUTO or REMOTE mode whenever you cycle the power. If you use a multi-function input terminal to switch between HAND (LOCAL) and AUTO (REMOTE) mode, the highest priority is the multi-function input terminal.
- The pulse of P00.20=4 (Pulse input without direction command) is input by DI7 (pulse generator).
- If P00.20 is set to 9-PID, P08.65 will automatically set to 1. To change P00.20 from 9 to another value, P08.65 must be changed first (to a value other than 1). We recommend setting P08.65 to 1 first - this will automatically lock P00.20 to a value of 9.

P00.21 Operation Command Source (AUTO, REMOTE)

Type	Hex Addr	Dec Addr
◆R/W	0015	40022
<i>Default</i>		

Range/Units (Format: 16-bit binary)

- 0: Digital keypad
 - 1: External terminals
 - 2: RS-485 communication input
 - 3: No function
 - 5: Communication card
- Note: HOA (Hand-Off-Auto) function is valid only when you use with DI function setting 41/42 or 56 or with GS4-KPD (optional)

P00.21 determines the operation frequency source in the “AUTO, REMOTE” mode.

- When Parameter 00.29 is in 0: HOA function, if the multi-function input terminal (DI) function setting 41 and 42 are OFF, the drive does not receive any operation command and JOG is invalid.
- The digital keypad is not capable of switching between AUTO and REMOTE. When P00.21=0, the ability to switch is essentially disabled.

P00.22 Stop Method

Type	Hex Addr	Dec Addr
◆R/W	0016	40023
<i>Default</i>		

Range/Units (Format: 16-bit binary)

- 0: Ramp to stop
- 1: Coast to stop

P00.22 determines how the motor is stopped when the drive receives the Stop command.

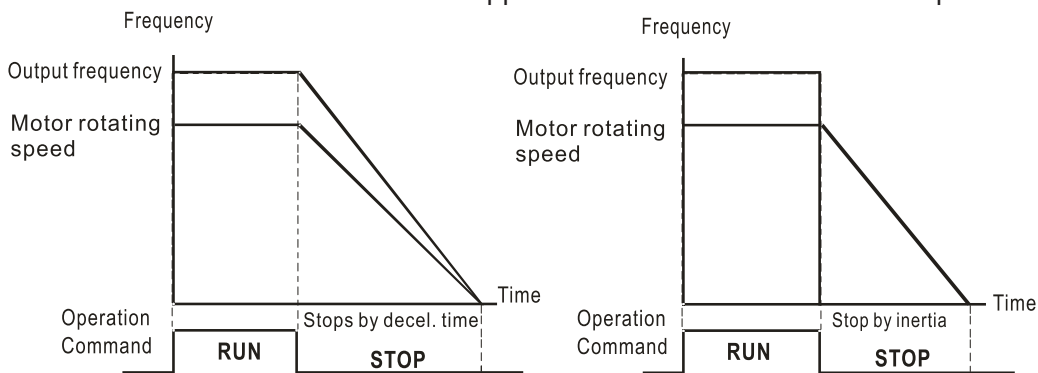

- 1) **Ramp to stop:** According to the set deceleration time, the AC motor drive decelerates to 0 Hz or the minimum output frequency (P01-07), and then stop.
- 2) **Coast to stop:** According to the load inertia, the AC motor drive stops output immediately, and the motor coasts to stop.

Use “ramp to stop” for the safety of personnel or to prevent material from being wasted in applications where the motor must stop immediately after the drive stops. You must set the deceleration time accordingly.

If idling is allowed or the load inertia is large, use “coast to stop”. For example, blowers, punching machines and pumps.

P00.23 Motor Direction Control

Type	Hex Addr	Dec Addr
◆R/W	0017	40024
<i>Default</i>		

Range/Units (Format: 16-bit binary)

- 0: Enable forward / reverse
- 1: Disable reverse
- 2: Disable forward

P00.23 enables the motor to run in the forward and reverse direction. You can use it to prevent a motor from running in a direction that would cause injury or damage to the equipment, especially when only one running direction is allowed for the motor load.

	<i>Type</i>	<i>Hex Addr</i>	<i>Dec Addr</i>
P00.24 Digital Operator (Keypad) Frequency Command Memory	Read	0018	40025
<i>Range/Units (Format: 16-bit unsigned)</i>	<i>Default</i>		
Read only	0		

If the keypad is the frequency command source, P00.24 stores the current frequency command when Lv or fault occurs.

P00.25	User-Defined Characteristics	Type	Hex Addr	Dec Addr
	<i>Range/Units (Format: 16-bit binary)</i>	◆R/W	0019	40026
		<u>Default</u>		
	bit 0–3: user-defined decimal places	0		
	0000h,0000b: no decimal place			
	0001h,0001b: one decimal place			
	0002h,0010b: two decimal places			
	0003h,0011b: three decimal places			
	bit 4–15: user-defined unit			
	000xh: Hz			
	001xh: rpm			
	002xh: %			
	003xh: kg			
	004xh: m/s			
	005xh: kW			
	006xh: HP			
	007xh: ppm			
	008xh: 1/m			
	009xh: kg/s			
	00Axh: kg/m			
	00Bxh: kg/h			
	00Cxh: lb/s			
	00Dxh: lb/m			
	00Exh: lb/h			
	00Fhx: ft/s			
	010xh: ft/m			
	011xh: m			
	012xh: ft			
	013xh: degC			
	014xh: degF			
	015xh: mbar			
	016xh: bar			
	017xh: Pa			
	018xh: kPa			
	019xh: mWG			
	01Axh: inWG			
	01Bxh: ftWG			
	01Cxh: psi			
	01Dxh: atm			
	01Exh: L/s			
	01Fhx: L/m			
	020xh: L/h			
	021xh: m3/s			
	022xh: m3/h			
	023xh: GPM			
	024xh: CFM			
	xxxxh: Hz			

P00.25 configures the decimal places and units of displayed data.

- bit 0–3:
The displayed units for the control frequency F page and user-defined (P00.04 = d10, PID feedback), and the displayed number of decimal places for P00.26 (support up to three decimal places).
- bit 4–15:
The displayed units for the control frequency F page, user-defined (P00.04 = d10, PID feedback) and P00.26.

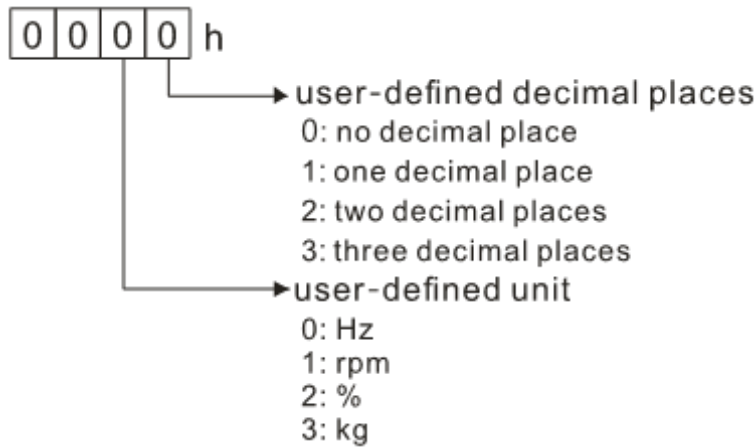

- You must convert the setting value to decimal when using the keypad to set parameters.

Example:

Assume that the user-defined unit is inWG and user-defined decimal place is the third decimal point. According to the information above, the corresponding unit to inWG is 01Axh (x is the set decimal point), and the corresponding unit to the third decimal place is 0003h, then inWG and the third decimal point displayed in hexadecimal is 01A3h, that is 419 in decimal value. Thus, set P00.25 = 419 to complete the setting.

	<u>Type</u>	<u>Hex Addr</u>	<u>Dec Addr</u>
P00.26 Maximum User-Defined Value	R/W	001A	40027
<u>Range/Units (Format: 16-bit unsigned)</u>	<u>Default</u>		
0: Disable	0		
0–65535 (when P00.25 is set to no decimal place)			
0.0–6553.5 (when P00.25 is set to one decimal place)			
0.00–655.35 (when P00.25 is set to two decimal places)			
0.000–65.535 (when P00.25 is set to three decimal places)			

When P00.26 is NOT set to 0, the user-defined value is enabled. After selecting the displayed unit and number of decimal places with P00.25, the setting value of P00.26 corresponds to P01.00 (drive’s maximum operating frequency).

Example:

When the frequency set in P01.00 = 60.00 Hz, the maximum user-defined value for P00.26 is 100.0%. This also means that P00.25 is set at 33 (0021h) to select % as the unit.

Set P00.25 before using P00.26. After you finish setting, when P00.26 is not 0, the displayed unit on the keypad shows correctly according to P00.25 settings.

	<u>Type</u>	<u>Hex Addr</u>	<u>Dec Addr</u>
P00.27 User-Defined Value	Read	001B	40028
<u>Range/Units (Format: 16-bit signed)</u>	<u>Default</u>		
Read only	0		

P00.27 displays the user-defined value when P00.26 is not set to 0.

The user-defined value is valid only when P00.20 (frequency source) is set to the digital keypad or to RS-485 communication.

P00.29 LOCAL / REMOTE Selection	Type	Hex Addr	Dec Addr
	R/W	001D	40030
<i>Range/Units (Format: 16-bit binary)</i>	<i>Default</i>		
0: Standard HOA function	4		
1: When switching between local and remote, the drive stops.			
2: When switching between local and remote, the drive runs with REMOTE settings for frequency and operating status.			
3: When switching between local and remote, the drive runs with LOCAL settings for frequency and operating status.			
4: When switching between local and remote, the drive runs with LOCAL settings when switched to Local and runs with REMOTE settings when switched to Remote for frequency and operating status.			

The default for P00.29 is 4, Local/Remote maintain.. Set the Local and Remote frequency and operation source with P00.20, P00.21 and P00.30, P00.31. The external terminal function (DI) = 56 for LOC / REM mode selection is disabled when P00.29=0.

- If P00.29 is not set to 0, the top right corner of digital keypad GS4-KPD (optional) displays LOC or REM. Set the REMOTE and LOCAL frequency and operation source with P00.20, P00.21 and P00.30, P00.31. Set the multi-function input terminal (DI) = 56 to set the LOC / REM selection. The AUTO key on the GS4-KPD (optional) is the REMOTE function; the HAND key is the LOCAL function.
- If P00.29 is not set to 0, the AUTO / HAND keys are disabled. In this case, the external terminal (DI) setting = 56 (local / remote selection) has the highest command priority.

P00.30 Master Frequency Command Source (HAND, LOCAL)	Type	Hex Addr	Dec Addr
	◆R/W	001E	40031
<i>Range/Units (Format: 16-bit binary)</i>	<i>Default</i>		
0: Digital keypad	0		
1: RS-485 communication input			
2: External analog input (refer to P03.00)			
3: External UP / DOWN terminal (multi-function input terminals)			
4: Pulse input (DI7) without direction command (refer to P10.16 without considering direction)			
6: No function			
7: Digital Keypad VR/Potentiometer Dial (GS20 only)			
8: Communication card			
9: PID controller			
Note: HOA (Hand-Off-Auto) function is valid only when you use with DI function setting 41/42 or 56 or with GS4-KPD (optional).			

P00.30 determines the master frequency source in the "HAND, LOCAL" mode.

- You can switch the HAND, LOCAL mode with the keypad GS4-KPD (optional) or the multi-function input terminal (DI) to set the master frequency source.
- It returns to AUTO or REMOTE mode whenever you cycle the power. If you use a multi-function input terminal to switch between HAND (LOCAL) and AUTO (REMOTE) mode, the highest priority is the multi-function input terminal.
- The pulse of P00.20=4 (Pulse input without direction command) is input by DI7 (pulse generator).
- If P00.30 is set to 9-PID, P08.65 will automatically set to 1 and P00.20 will set to 9. To change P00.30 from 9 to another value, P08.65 must be changed first (to a value other than 1). Setting P00.30 to 9 only allows PID control frequency from P08.65 and P08.66 for both local and remote drive mode.

	<i>Type</i>	<i>Hex Addr</i>	<i>Dec Addr</i>
P00.31 Operation Command Source (HAND, LOCAL)	◆R/W	001F	40032
<i>Range/Units (Format: 16-bit binary)</i>	<i>Default</i>		
0: Digital keypad	0		
1: External terminal			
2: RS-485 communication input			
3: No function			
5: Communication card			
Note: HOA (Hand-Off-Auto) function is valid only when you use with DI function setting 41/42 or 56 or with GS4-KPD (optional).			

P00.31 determines the operation frequency source in the "HAND, LOCAL" mode.

In the HOA mode, if the multi-function input terminal (DI) function setting 41 and 42 are OFF, the drive does not receive any operation command and JOG is invalid

	<i>Type</i>	<i>Hex Addr</i>	<i>Dec Addr</i>
P00.32 Digital Keypad STOP Function	◆R/W	0020	40033
<i>Range/Units (Format: 16-bit binary)</i>	<i>Default</i>		
0: STOP key disabled	0		
1: STOP key enabled			

P00.32 disables or enables the STOP key.

Valid when the operation command source is not the digital keypad (P00.21≠0). When P00.21=0, the STOP key on the digital keypad is not affected by this parameter.

	<i>Type</i>	<i>Hex Addr</i>	<i>Dec Addr</i>
P00.35 Auxiliary Frequency Source	R/W	0023	40036
<i>Range/Units (Format: 16-bit binary)</i>	<i>Default</i>		
0: Master and auxiliary frequency function disabled	0		
1: Digital keypad			
2: RS-485 communication input			
3: Analog input			
4: External UP / DOWN key input (multi-function input terminals)			
5: Pulse input (DI7) without direction command (refer to P10.16)			
6: No function			
7: Digital Keypad VR/Potentiometer Dial (GS20 only)			
8: Communication card			

P00.35 determines the source for auxiliary frequency control.

	<i>Type</i>	<i>Hex Addr</i>	<i>Dec Addr</i>
P00.36 Master and Auxiliary Frequency Command Selection	R/W	0024	40037
<i>Range/Units (Format: 16-bit binary)</i>	<i>Default</i>		
0: Master + auxiliary frequency	0		
1: Master - auxiliary frequency			
2: Auxiliary - master frequency			

P00.36 sets the master frequency source according to P00.20, and sets the auxiliary frequency source according to P00.35. This parameter determines the addition and subtraction of the master and auxiliary frequency.

- When P00.36 = 0, 1, 2, the control command comes after adding or subtracting the master / auxiliary frequency and the acceleration and deceleration (including S-curve).

- If the value is negative after adding or subtracting the master / auxiliary frequency, P03.10 determines whether to change the running direction.
- If you set the master frequency source (P00.20 = 0) or the auxiliary frequency source (P00.35 = 1) using the keypad, the F page of the keypad displays the setting frequency that you can use to set the master frequency or the auxiliary frequency. If the master frequency source or the auxiliary frequency source is NOT set by the keypad (P00.20 ≠ 0 and P00.35 ≠ 1), the F page of the keypad displays the value after adding or subtracting the master / auxiliary frequency.
- When setting the master frequency source and auxiliary frequency source, P00.35 cannot be set to the same value as P00.20 or P00.30

	<u>Type</u>	<u>Hex Addr</u>	<u>Dec Addr</u>
P00.48 Display Filter Time (Current)	◆R/W	0030	40049
<u>Range/Units (Format: 16-bit unsigned)</u>	<u>Default</u>		
0.001–65.535 sec.	0.100		

P00.48 minimizes the current fluctuation displayed by the digital keypad.

	<u>Type</u>	<u>Hex Addr</u>	<u>Dec Addr</u>
P00.49 Display Filter Time (User Display)	◆R/W	0031	40050
<u>Range/Units (Format: 16-bit unsigned)</u>	<u>Default</u>		
0.001–65.535 sec.	0.100		

P00.49 minimizes the value fluctuation displayed by the digital keypad configurable user display. The filtering applies to P00.04 selections 0, 2, 4, 6, and 7 only. The default value of 0.100 disables the filtering.

	<u>Type</u>	<u>Hex Addr</u>	<u>Dec Addr</u>
P00.50 Firmware Version (Date) Code	Read	0032	40051
<u>Range/Units (Format: 16-bit unsigned)</u>	<u>Default</u>		
Read only	0		

P00.50 displays the current drive firmware version by date.

GROUP P01.xx DETAILS – BASIC PARAMETERS

		<u>Type</u>	<u>Hex Addr</u>	<u>Dec Addr</u>
P01.00	Maximum Operation Frequency of Motor 1	R/W	0100	40257
P01.52	Maximum Operation Frequency of Motor 2	R/W	0134	40309
P01.53	Maximum Operation Frequency of Motor 3	R/W	0135	40310
P01.62	Maximum Operation Frequency of Motor 4	R/W	013E	40319
	<u>Range/Units (Format: 16-bit unsigned)</u>	<u>Default</u>		
	0.00–599.00 Hz	60.00 / 50.00		

These parameters determine the AC motor drive's maximum operation frequency. All the AC motor drive frequency command sources (analog inputs 0–10 V, 4–20 mA, 0–20 mA, ± 10 V) are scaled to correspond to the output frequency range.

		<u>Type</u>	<u>Hex Addr</u>	<u>Dec Addr</u>
P01.01	Output Frequency of Motor 1 (Base frequency / Motor's rated frequency)	R/W	0101	40258
P01.35	Output Frequency of Motor 2 (Base frequency / Motor's rated frequency)	R/W	0123	40292
P01.54	Output Frequency of Motor 3 (Base frequency / Motor's rated frequency)	R/W	0136	40311
P01.63	Output Frequency of Motor 4 (Base frequency / Motor's rated frequency)	R/W	013E	40319
	<u>Range/Units (Format: 16-bit unsigned)</u>	<u>Default</u>		
	0.00–599.00 Hz	60.00 / 50.00		

Set these parameters according to the motor's rated frequency on the motor nameplate. If the motor's rated frequency is 60Hz, set this parameter to 60. If the motor's rated frequency is 50Hz, set this parameter to 50.

		<u>Type</u>	<u>Hex Addr</u>	<u>Dec Addr</u>
P01.02	Output Voltage of Motor 1 (Base voltage / Motor's rated voltage)	R/W	0102	40259
P01.36	Output Voltage of Motor 2 (Base voltage / Motor's rated voltage)	R/W	0124	40293
P01.55	Output Voltage of Motor 3 (Base voltage / Motor's rated voltage)	R/W	0137	40312
P01.64	Output Voltage of Motor 4 (Base voltage / Motor's rated voltage)	R/W	0140	40321
	<u>Range/Units (Format: 16-bit unsigned)</u>	<u>Default</u>		
	120V / 230V models: 0.0–255.0 V	220.0		
	460V models: 0.0–510.0 V	440.0		
	575V models: 0.0–637.0 V	575.0		

Set these parameters according to the rated voltage on the motor nameplate. If the motor's rated voltage is 220V, set this parameter to 220.0. If the motor's rated voltage is 200V, set this parameter to 200.0.

		<u>Type</u>	<u>Hex Addr</u>	<u>Dec Addr</u>
P01.03	Mid-point Frequency 1 of Motor 1	R/W	0103	40260
P01.37	Mid-point Frequency 1 of Motor 2	R/W	0125	40294
P01.56	Mid-point Frequency 1 of Motor 3	R/W	0138	40313
P01.65	Mid-point Frequency 1 of Motor 4	R/W	0141	40322
	<u>Range/Units (Format: 16-bit unsigned)</u>	<u>Default</u>		
	0.00–599.00 Hz	3.00		

	Type	Hex Addr	Dec Addr
P01.04 <i>Mid-point Voltage 1 of Motor 1</i>	◆R/W	0104	40261
P01.38 <i>Mid-point Voltage 1 of Motor 2</i>	◆R/W	0126	40295
P01.57 <i>Mid-point Voltage 1 of Motor 3</i>	◆R/W	0139	40314
P01.66 <i>Mid-point Voltage 1 of Motor 4</i>	◆R/W	0142	40323
<i>Range/Units (Format: 16-bit unsigned)</i>	<i>Default</i>		
120V / 230V models: 0.0–240.0 V	11.0		
460V models: 0.0–480.0 V	22.0		
575V models: 0.0–600.0 V	40.0		
	Type	Hex Addr	Dec Addr
P01.05 <i>Mid-point Frequency 2 of Motor 1</i>	R/W	0105	40262
P01.39 <i>Mid-point Frequency 2 of Motor 2</i>	R/W	0127	40296
P01.58 <i>Mid-point Frequency 2 of Motor 3</i>	R/W	013A	40315
P01.67 <i>Mid-point Frequency 2 of Motor 4</i>	R/W	0143	40324
<i>Range/Units (Format: 16-bit unsigned)</i>	<i>Default</i>		
0.00–599.00 Hz	1.50		
	Type	Hex Addr	Dec Addr
P01.06 <i>Mid-point Voltage 2 of Motor 1</i>	◆R/W	0106	40263
P01.40 <i>Mid-point Voltage 2 of Motor 2</i>	◆R/W	0128	40297
P01.59 <i>Mid-point Voltage 2 of Motor 3</i>	◆R/W	013B	40316
P01.68 <i>Mid-point Voltage 2 of Motor 4</i>	◆R/W	0144	40325
<i>Range/Units (Format: 16-bit unsigned)</i>	<i>Default</i>		
120V / 230V models: 0.0–240.0 V	5.0		
460V models: 0.0–480.0 V	10.0		
575V models: 0.0–600.0 V	26.1		
	Type	Hex Addr	Dec Addr
P01.07 <i>Minimum Output Frequency of Motor 1</i>	R/W	0107	40264
P01.41 <i>Minimum Output Frequency of Motor 2</i>	R/W	0129	40298
P01.60 <i>Minimum Output Frequency of Motor 3</i>	R/W	013C	40317
P01.69 <i>Minimum Output Frequency of Motor 4</i>	R/W	0145	40326
<i>Range/Units (Format: 16-bit unsigned)</i>	<i>Default</i>		
0.00–599.00 Hz	0.50		



NOTE: P01.07 will set the V/F mode minimum frequency only. Use P01.11 to set the minimum frequency of the drive for any control mode.

	Type	Hex Addr	Dec Addr
P01.08 <i>Minimum Output Voltage of Motor 1</i>	◆R/W	0108	40265
P01.42 <i>Minimum Output Voltage of Motor 2</i>	◆R/W	012A	40299
P01.61 <i>Minimum Output Voltage of Motor 3</i>	◆R/W	013D	40318
P01.70 <i>Minimum Output Voltage of Motor 4</i>	◆R/W	0146	40327
<i>Range/Units (Format: 16-bit unsigned)</i>	<i>Default</i>		
120V / 230V models: 0.0–240.0 V	1.0		
460V models: 0.0–480.0 V	2.0		
575V models: 0.0–600.0 V	16.7		

You usually set the V/F curve according to the motor’s allowable loading characteristics. Pay special attention to the motor’s heat dissipation, dynamic balance, and bearing lubrication when the loading characteristics exceed the loading limit of the motor.

There is no limit for the voltage setting, but a high voltage at a low frequency may cause motor damage, overheating, and trigger the stall prevention or the over-current protection; therefore, use low voltage at low frequency to prevent motor damage or drive error.

The diagram below shows the V/F curve for motor 1. You can use the same V/F curve for motor 2, motor 3, and motor 4. For multi-motor selections, refer to the multi-function input terminal (P02.01–P02.07) settings 83 and 84.

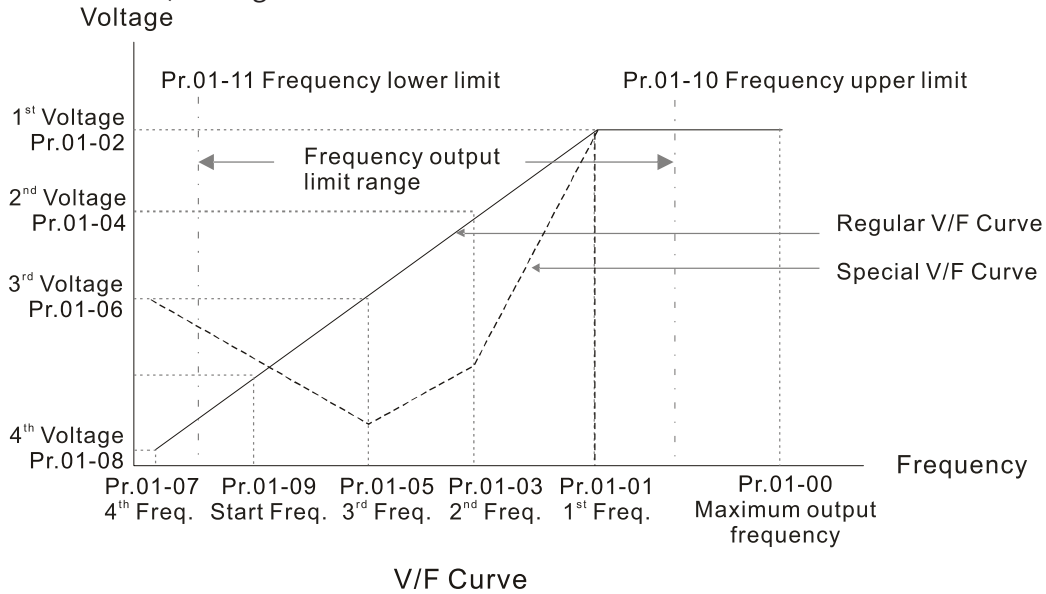

Common settings for the V/F curve:

1) General purpose:

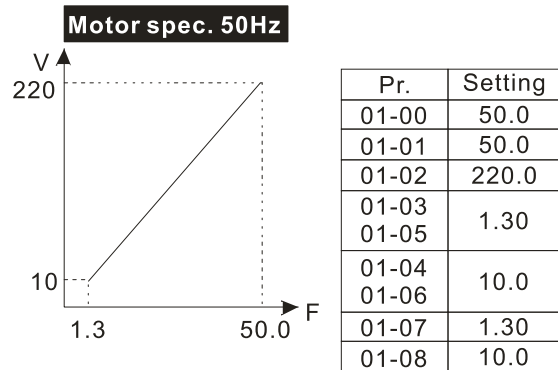
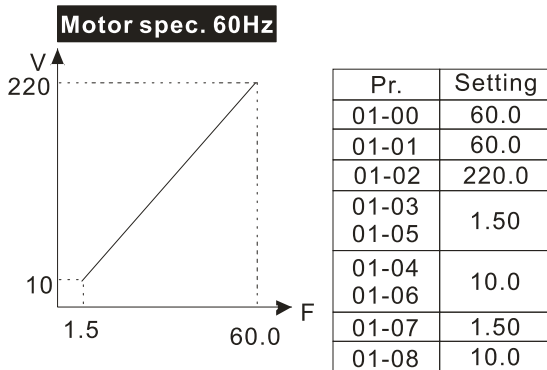

2) For fan and hydraulic machinery:

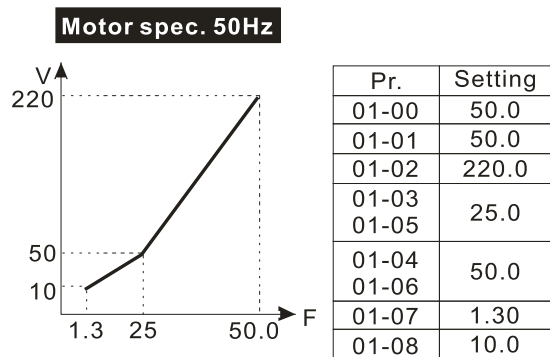
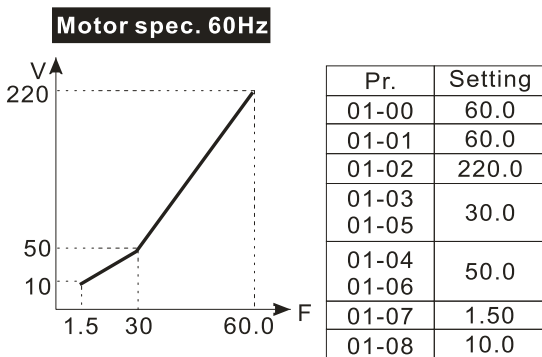

3) High starting torque:

Motor spec. 60Hz

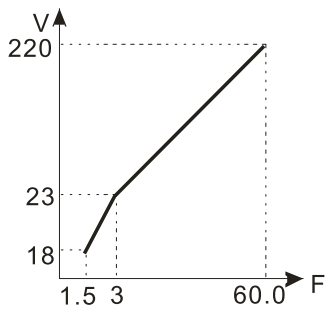

Pr.	Setting
01-00	60.0
01-01	60.0
01-02	220.0
01-03	3.00
01-04	23.0
01-06	23.0
01-07	1.50
01-08	18.0

Motor spec. 50Hz

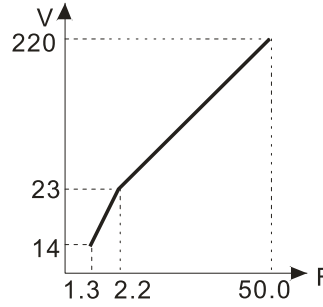

Pr.	Setting
01-00	50.0
01-01	50.0
01-02	220.0
01-03	2.20
01-05	2.20
01-04	23.0
01-06	23.0
01-07	1.30
01-08	14.0

P01.09 Start-up Frequency

Range/Units (Format: 16-bit unsigned)

0.00–599.00 Hz

Type Hex Addr Dec Addr

R/W 0109 40266

Default

0.50

P01.09 is used to set the starting frequency of the drive.

- When the starting frequency (P01.09) is larger than the minimum output frequency (P01.11), the drive's frequency output starts when the starting frequency (P01.09) reaches the F command. Refer to the diagram below for details.
- Fcmd = frequency command;
Fstart = start-up frequency (P01.09);
fstart = actual start-up frequency of the drive;
Fmin = 4th output frequency setting (P01.07 / P01.41);
Flow = output frequency lower limit (P01.11)
- When Fcmd > Fmin and Fcmd < Fstart:
If Flow < Fcmd, the drive runs directly with Fcmd.
If Flow ≥ Fcmd, the drive runs with Fcmd, and then rises to Flow according to acceleration time.
- The drive's output frequency goes directly to 0 when decelerating to Fmin.

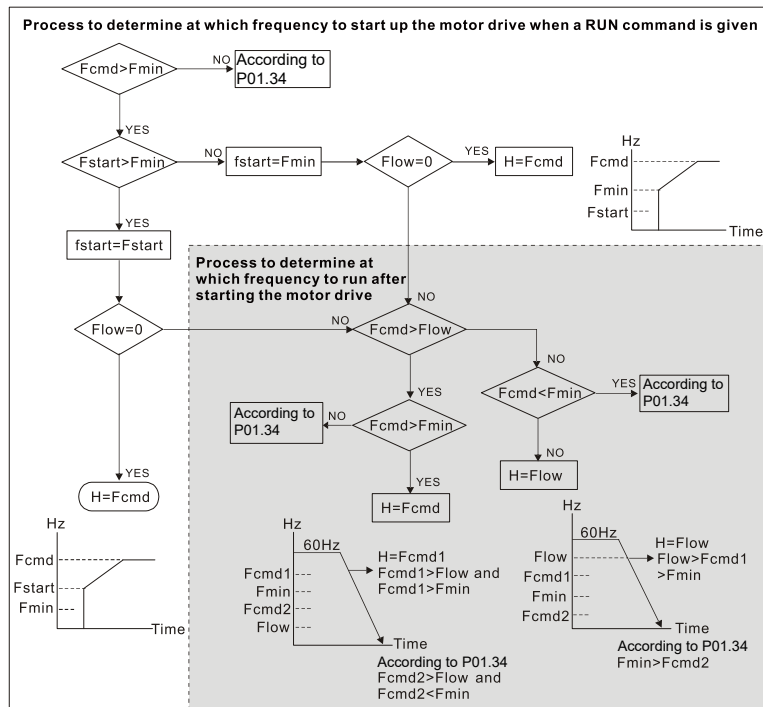

	Type	Hex Addr	Dec Addr
P01.10 Output Frequency Upper Limit	◆R/W	010A	40267
<i>Range/Units (Format: 16-bit unsigned)</i>	<i>Default</i>		
0.00–599.00 Hz	599.0		

	Type	Hex Addr	Dec Addr
P01.11 Output Frequency Lower Limit	◆R/W	010B	40268
<i>Range/Units (Format: 16-bit unsigned)</i>	<i>Default</i>		
0.00–599.00 Hz	0.00		

Use the upper and lower limit output frequency settings to limit the actual output frequency. If the output frequency setting is higher than the upper limit (P01.10), the drive runs with the upper limit frequency. If the output frequency setting is lower than the lower limit (P01.11) but higher than the minimum output frequency (P01.07), the drive runs with the lower limit frequency. Set the upper limit frequency > the lower limit frequency (P01.10 setting value must be > P01.11 setting value).

- The upper output frequency limits the drive’s maximum output frequency. If the frequency setting for the Frequency command is higher than P01.10, the drive runs with the P01.10 setting.
- If the PID feedback control is enabled for the drive, the drive’s output frequency may exceed the Frequency command but is still limited by this setting.
- Related parameters: P01.00 Maximum Operation Frequency, P01.11 Output Frequency Lower Limit.

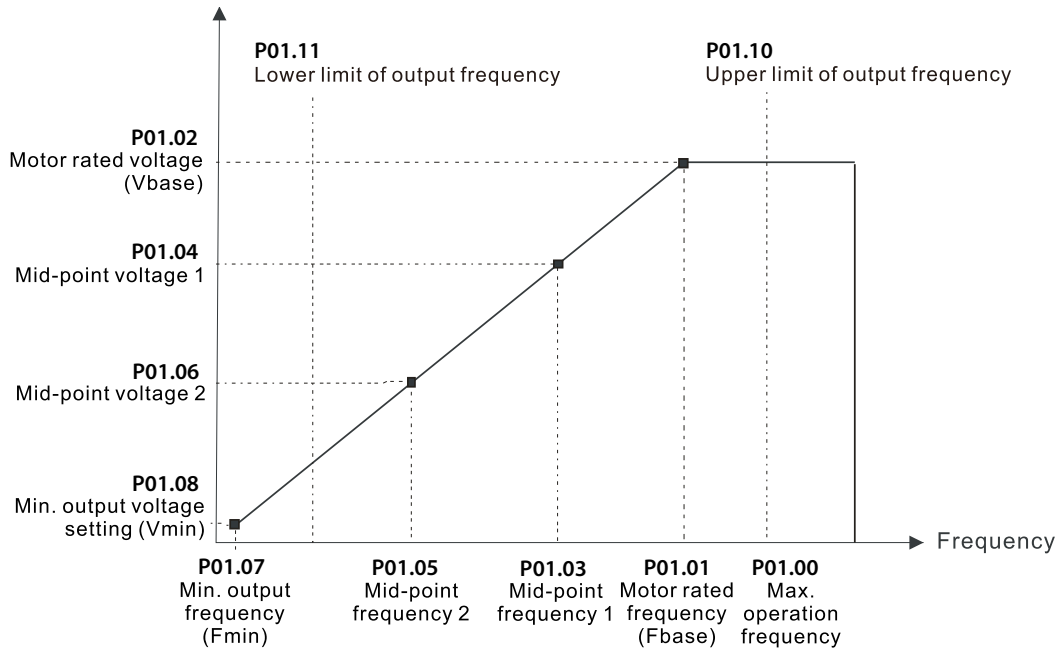

- The lower output frequency limits the drive’s minimum output frequency. If the frequency setting for the Frequency command is lower than P01.11, the drive runs with the P01.11 setting.
- When the drive starts, it operates according to the V/F curve and accelerates from the minimum output frequency (P01.07) to the setting frequency. It is not limited by the lower output frequency settings.
- Use the output frequency upper and lower limit settings to prevent operator misuse, overheating caused by the motor’s operating at a too low frequency, or mechanical wear due to a too high speed.
- If the output frequency upper limit setting is 50Hz and the frequency setting is 60Hz, the maximum output frequency is 50Hz.
- If the output frequency lower limit setting is 10Hz and the minimum output frequency setting (P01.07) is 1.5 Hz, then the drive operates at 10Hz when the Frequency command is higher than P01.07 but lower than 10Hz. If the Frequency command is lower than P01.07, the drive is in ready status without output.

- If the frequency output upper limit is 60Hz and the frequency setting is also 60Hz, only the Frequency command is limited at 60Hz. The actual output frequency may be higher than 60Hz if used for slip compensation.

	Type	Hex Addr	Dec Addr
P01.12 Acceleration Time 1	◆R/W	010C	40269
P01.13 Deceleration Time 1	◆R/W	010D	40270
P01.14 Acceleration Time 2	◆R/W	010E	40271
P01.15 Deceleration Time 2	◆R/W	010F	40272
P01.16 Acceleration Time 3	◆R/W	0110	40273
P01.17 Deceleration Time 3	◆R/W	0111	40274
P01.18 Acceleration Time 4	◆R/W	0112	40275
P01.19 Deceleration Time 4	◆R/W	0113	40276
P01.20 JOG Acceleration Time	◆R/W	0114	40277
P01.21 JOG Deceleration Time	◆R/W	0115	40278
<i>Range/Units (Format: 16-bit unsigned)</i>	<i>Default</i>		
P01.45 = 0: 0.00–600.00 sec.	10.00 / 10.0		
P01.45 = 1: 0.0–6000.0 sec.			

The acceleration time determines the time required for the AC motor drive to ramp from 0.00 Hz to the maximum operation frequency (P01.00). The deceleration time determines the time required for the AC motor drive to decelerate from the maximum operation frequency (P01.00) down to 0.00 Hz.

- The acceleration and deceleration time are invalid when using P01.44 Auto-acceleration and Auto-deceleration Setting.
- Select the Acceleration/Deceleration Time 1, 2, 3, 4 with the multi-function input terminal settings. The defaults are Acceleration Time 1 and Deceleration Time 1.
- With the enabled torque limits and stall prevention functions, the actual acceleration and deceleration time are longer than the above action time.
- Note that setting the acceleration and deceleration time too short may trigger the drive's protection function (P06.03 Over-current Stall Prevention during Acceleration or P06.01 Over-voltage Stall Prevention), and the actual acceleration and deceleration time are longer than this setting.
- Note that setting the acceleration time too short may cause motor damage or trigger drive protection due to over-current during the drive's acceleration.
- Note that setting the deceleration time too short may cause motor damage or trigger drive protection due to over-current during the drive's deceleration or over-voltage.
- Use suitable braking resistors (refer to Appendix A: Accessories) to decelerate in a short time and prevent over-voltage.
- When you enable P01.24–P01.27 (S-curve acceleration and deceleration begin and arrival time), the actual acceleration and deceleration time are longer than the setting.

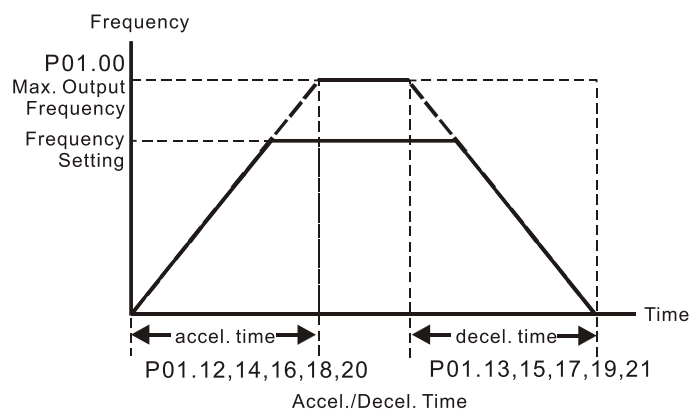

	Type	Hex Addr	Dec Addr
P01.22 JOG Frequency	◆R/W	0116	40279
<i>Range/Units (Format: 16-bit unsigned)</i>	<i>Default</i>		
0.00–599.00 Hz	6.00		

You can use both the external terminal JOG and F1 key on the optional keypad GS4-KPD (optional) to set the JOG function. When the JOG command is ON, the AC motor drive accelerates from 0 Hz to the JOG frequency (P01.22). When the JOG command is OFF, the AC motor drive decelerates from the JOG frequency to stop. The JOG acceleration and deceleration time (P01.20, P01.21) are the time to accelerate from 0.00 Hz to the JOG frequency (P01.22). You cannot execute the JOG command when the AC motor drive is running. When the JOG command is executing, other operation commands are invalid.

	Type	Hex Addr	Dec Addr
P01.23 Switch Frequency between First and Fourth Accel./Decel.	◆R/W	0117	40280
<i>Range/Units (Format: 16-bit unsigned)</i>	<i>Default</i>		
0.00–599.00 Hz	0.00		

This function does not require the external terminal switching function; it switches the acceleration and deceleration time automatically according to the P01.23 setting. If you set the external terminal, the external terminal has priority over P01.23.

When using this function, set the S-curve acceleration time to 0 if the fourth acceleration time is short.

- 1) If P01.12=10s, P 01.18=6s, then the acceleration time is 3s for 0–40 Hz and 5s for 40–80 Hz.
- 2) If P01.13=8s, P01.19=2s, then the deceleration time is 4s for 80–40 Hz and 1s for 40–0 Hz.

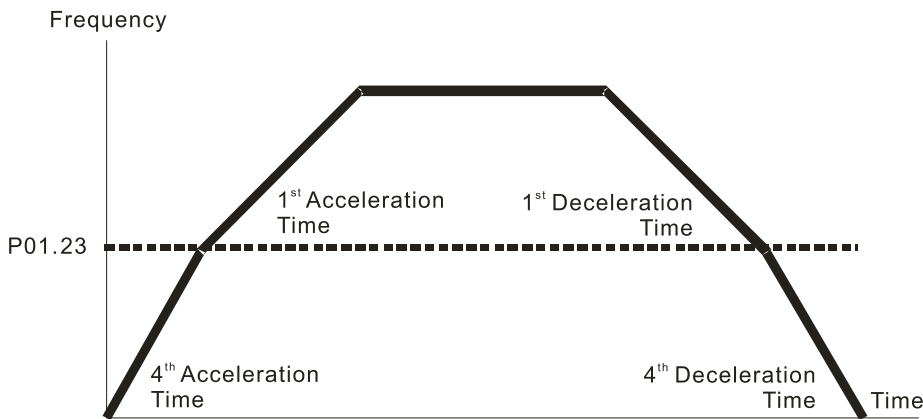

1st/4thAcceleration/Deceleration Frequency Switching

	Type	Hex Addr	Dec Addr
P01.24 S-curve for Acceleration Begin Time 1	◆R/W	0118	40281
P01.25 S-curve for Acceleration Arrival Time 2	◆R/W	0119	40282
P01.26 S-curve for Deceleration Begin Time 1	◆R/W	011A	40283
P01.27 S-curve for Deceleration Arrival Time 2	◆R/W	011B	40284
<i>Range/Units (Format: 16-bit unsigned)</i>	<i>Default</i>		
If P01.45 = 0: 0.00–25.00 sec.	0.20		
If P01.45 = 1: 0.0–250.0 sec.	0.2		

These parameters allow you to enable an S-curve. Using an S-curve gives the smoothest transition between speed changes. The acceleration and deceleration curve adjusts the acceleration and deceleration S-curve. When enabled, the drive produces a different acceleration and deceleration curve according to the acceleration and deceleration time.

- The S-curve function is invalid when you set the acceleration and deceleration time to 0.
- For P01.12, P01.14, P01.15, and P01.18:
When $P01.1x \geq P01.24$ and $P01.25$, the actual acceleration time = $P01.1x + (P01.24 + P01.25) / 2$.
- For P01.13, P01.15, P01.17, and P01.19:
When $P01.1x \geq P01.26$ and $P01.27$, the actual deceleration time = $P01.1x + (P01.26 + P01.27) / 2$.

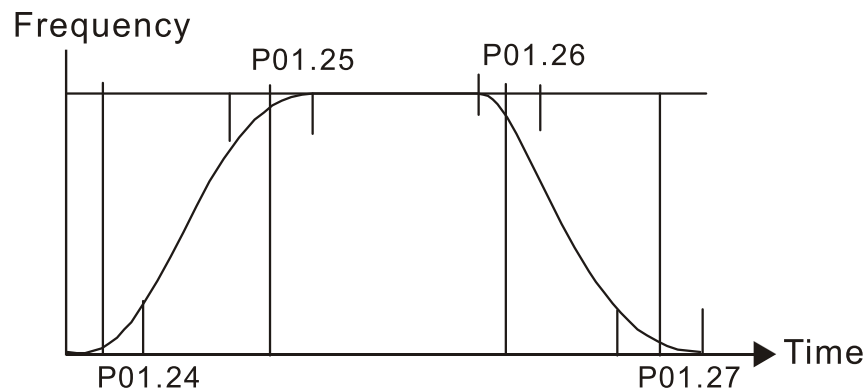

	Type	Hex Addr	Dec Addr
P01.28 Skip Frequency 1 (Upper Limit)	R/W	011C	40285
P01.29 Skip Frequency 1 (Lower Limit)	R/W	011D	40286
P01.30 Skip Frequency 2 (Upper Limit)	R/W	011E	40287
P01.31 Skip Frequency 2 (Lower Limit)	R/W	011F	40288
P01.32 Skip Frequency 3 (Upper Limit)	R/W	0120	40289
P01.33 Skip Frequency 3 (Lower Limit)	R/W	0121	40290
<i>Range/Units (Format: 16-bit unsigned)</i>	<i>Default</i>		
0.00–599.00 Hz	0.00		

These parameters set the AC motor drive's skip frequency. The drive's frequency setting skips these frequency ranges. However, the frequency output is continuous. There are no limits for these six parameters and you can combine them. P01.28 does not need to be greater than P01.29; P01.30 does not need to be greater than P01.31; P01.32 does not need to be greater than P01.33. You can set P01.28–01.33 as required. There is no size distinction among these six parameters.

- These parameters set the skip frequency ranges for the AC motor drive. You can use this function to avoid frequencies that cause mechanical resonance. The skip frequencies are useful when a motor has resonance vibration at a specific frequency bandwidth. Skipping this frequency avoids the vibration. There are three frequency skip zones available.
- You can set the Frequency command (F) within the range of skip frequencies. Then the output frequency (H) is limited to the lower limit of skip frequency ranges.
- During acceleration and deceleration, the output frequency still passes through the skip frequency ranges.

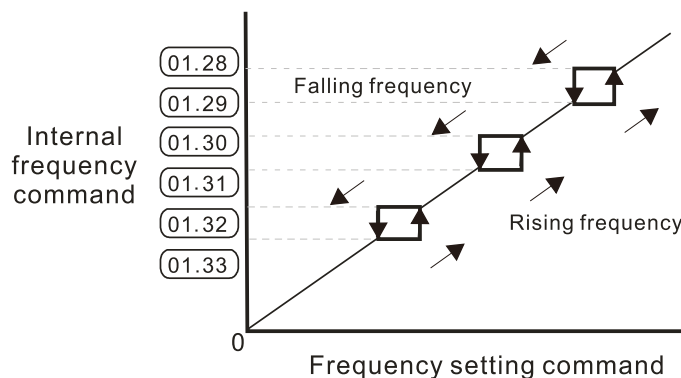

		Type	Hex Addr	Dec Addr
P01.34	Zero-speed Mode	R/W	0122	40291
<i>Range/Units (Format: 16-bit binary)</i>		<i>Default</i>		
0: Output waiting		0		
1: Zero-speed operation				
2: Fmin (refer to P01.07 and P01.41)				

When the drive’s Frequency command is lower than Fmin (P01.07 and P01.41), the drive operates according to this parameter.

- 0: the AC motor drive is in waiting mode without voltage output from terminals U, V, W.
- 1: the drive executes the DC brake by Vmin (P01.08 and P01.42) in V/F, FOC sensorless, and SVC modes. And it executes zero-speed operation in VFPG mode.
- 2: the AC motor drive runs using Fmin (P01.07 and P01.41) and Vmin (P01.08 and P01.42) in V/F, VFPG, SVC, and FOC sensorless modes.

In V/F, VFPG, SVC and FOC sensorless modes:

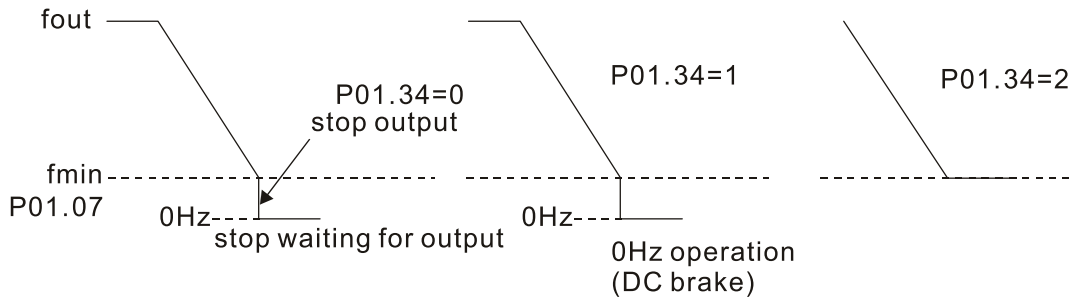

		Type	Hex Addr	Dec Addr
P01.43	V/F Curve Selection	R/W	012B	40300
<i>Range/Units (Format: 16-bit binary)</i>		<i>Default</i>		
0: V/F curve determined by P.01.00–P01.08		0		
1: V/F curve to the power of 1.5				
2: V/F curve to the power of 2				

P01.43 is used to select the desired V/F curve for your application.

- When setting to 0, refer to P01.01–01.08 for the motor 1 V/F curve. For motor 2, refer to P01.35–01.42. For motor 3, refer to P01.54–P01.61. For motor 4, refer to P01.35–P01.42.
- When setting to 1 or 2, the second and third voltage frequency settings (as shown in the V/F Curve diagram for P01.70) are invalid.
- If the load of the motor is a variable torque load (torque is in direct proportion to the rotating speed, such as the load of a fan or a pump), the load torque is low at low rotating speed. You can decrease the input voltage appropriately to make the magnetic field of the input current smaller and reduce flux loss and iron loss for the motor to increase efficiency.
- When you set the V/F curve to high power, it has lower torque at low frequency, and the drive is not suitable for rapid acceleration and deceleration. Do NOT use this parameter for rapid acceleration and deceleration.

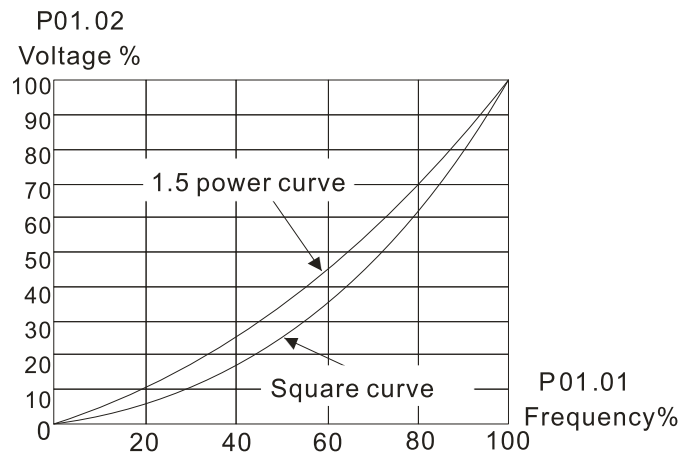

P01.44 Auto-acceleration and Auto-deceleration Setting

Range/Units (Format: 16-bit binary)

- 0: Linear acceleration and deceleration
- 1: Auto-acceleration and linear deceleration
- 2: Linear acceleration and auto-deceleration
- 3: Auto-acceleration and auto-deceleration
- 4: Stall prevention by auto-acceleration and auto-deceleration (limited by P01.12 –P01.21)

Type	Hex Addr	Dec Addr
◆R/W	012C	40301
Default		
0		

P01.44 is used to configure auto-acceleration and auto-decleration settings.

- 0 (linear acceleration and deceleration): the drive accelerates and decelerates according to the setting for P01.12–P01.19.
- 1 or 2 (auto/linear acceleration and auto/linear deceleration): the drive auto-tunes the acceleration and deceleration to effectively reduce the mechanical vibration during the load start-up and stop and make the auto-tuning process easier. It does not stall during acceleration and does not need a braking resistor during deceleration to stop. It can also improve operation efficiency and save energy.
- 3 (auto-acceleration and auto-deceleration–decelerating by the actual load): the drive auto-detects the load torque and automatically accelerates from the fastest acceleration time and smoothest start-up current to the setting frequency. During deceleration, the drive automatically determines the loaded regenerative energy to steadily and smoothly stop the motor in the fastest deceleration time.
- 4 (stall prevention by auto-acceleration and deceleration–references the acceleration and deceleration time settings (P01.12 through P01.19). If the settings for acceleration and deceleration are too short, the actual acceleration and decleration times will be greater than the acceleration and deceleration time settings.

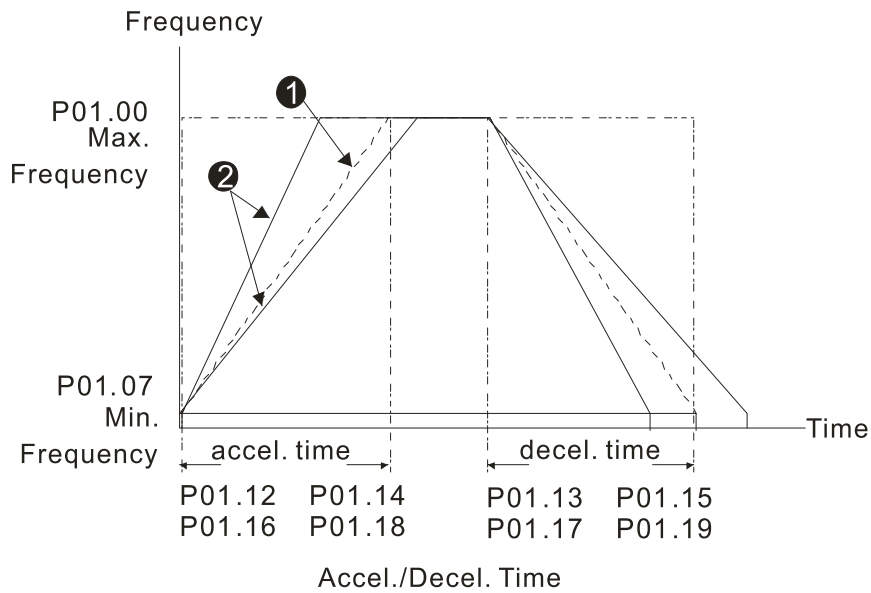

- ① When P01.44 is set to 0.
- ② When P01.44 is set to 3.

	Type	Hex Addr	Dec Addr
P01.45 <i>Time Unit for Acceleration and Deceleration and S-Curve</i>	R/W	012D	40302
<i>Range/Units (Format: 16-bit binary)</i>	<i>Default</i>		
0: Unit 0.01 sec.	0		
1: Unit 0.1 sec.			

	Type	Hex Addr	Dec Addr
P01.49 <i>Regenerative Energy Restriction Control Method</i>	R/W	0131	40306
<i>Range/Units (Format: 16-bit binary)</i>	<i>Default</i>		
0: Disable	0		
1: Over voltage energy restriction			
2: Traction energy control (TEC)			

P01.49 is used to select the regenerative energy restriction control method.

- 0: decelerate or stop in accordance with the original deceleration setting. The actual deceleration time of the motor is longer than the deceleration time setting because of the over-voltage stall prevention.
- 1: during deceleration, the drive controls the motor according to the setting for P06.01 and the recovery voltage of the DC bus. The controller starts when the DC bus voltage reaches 95% of P06.01. When P06.01 is set to 0, the drive controls the motor according to the operating voltage and the recovery voltage of the DC bus. This method decelerates according to the setting for the deceleration time. The fastest actual deceleration time is not less than the deceleration time setting.
- 2: during deceleration, the drive controls the motor according to the setting for P06.01 and the DC bus voltage. The controller starts when the DC bus voltage reaches 95% of P06.01, auto-tunes the output frequency and the output voltage to increase the consumption of the regenerative energy according to the drive's capability, and the deceleration time is the result of the drive's auto-tuning. Use this setting when over-voltage occurs due to unexpected deceleration time.

GROUP P02.xx DETAILS – DIGITAL INPUT/OUTPUT PARAMETERS

	Type	Hex Addr	Dec Addr
P02.00 Two-wire / Three-wire Operation Control	R/W	0200	40513
<i>Range/Units (Format: 16-bit binary)</i>	<i>Default</i>		
0: No function	1		
1: Two-wire mode 1, power on for operation control (DI1: FWD / STOP, DI2: REV / STOP)			
2: Two-wire mode 2, power on for operation control (DI1: RUN / STOP, DI2: REV / FWD)			
3: Three-wire, power on for operation control (DI1: RUN, DI2: REV / FWD, DI3: STOP)			
4: Two-wire mode 1, Quick Start (DI1: FWD / STOP, DI2: REV / STOP)			
5: Two-wire mode 2, Quick Start (DI1: RUN / STOP, DI2: REV / FWD)			
6: Three-wire, Quick Start (DI1: RUN, DI2: REV / FWD, DI3: STOP)			

P02.00 is used to set the 2-wire or 3-wire operation control mode.

- In the Quick Start function, the output remains ready for operation. The drive responds to the Start command immediately.
- When using Quick Start function, the output terminals UVW are with driving voltages in order to output and respond immediately if a Start command is given. Do NOT touch the terminals or modify the motor wiring to prevent electric shocks.
- This parameter sets the configuration of the external drive operation control and the Quick Start function. There are six different control modes listed in the following table.

P02.00	External Terminal Control Circuits
<p>Setting value: 1 Two-wire operation control FWD / STOP REV / STOP</p>	
<p>Setting value: 2 Two-wire operation control RUN / STOP FWD / REV</p>	
<p>Setting value: 3 Three-wire operation control</p>	

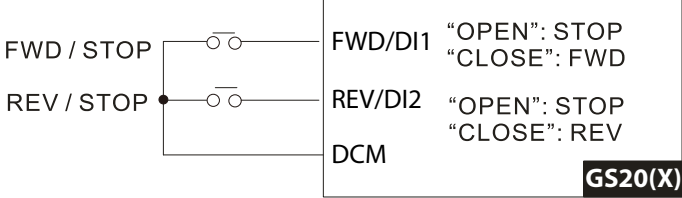
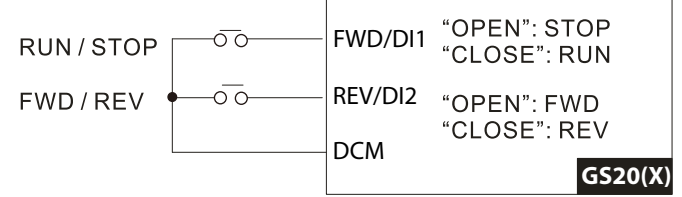
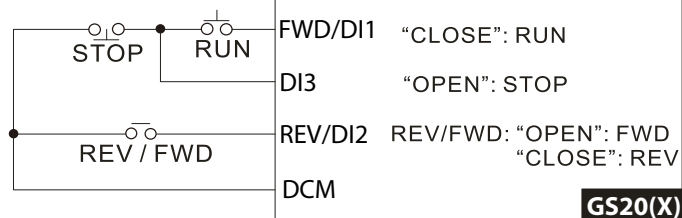
P02.00	External Terminal Control Circuits
<p>Setting value: 4 Two-wire operation control Quick Start</p>	
<p>Setting value: 5 Two-wire operation control Quick Start</p>	
<p>Setting value: 6 Three-wire operation control Quick Start</p>	

		Type	Hex Addr	Dec Addr	Default
<u>P02.01</u>	Multi-function input Command 1 (FWD/DI1)	R/W	0201	40514	0
<u>P02.02</u>	Multi-function input Command 2 (REV/DI2)	R/W	0202	40515	0
<u>P02.03</u>	Multi-function input Command 3 (DI3)	R/W	0203	40516	1
<u>P02.04</u>	Multi-function input Command 4 (DI4)	R/W	0204	40517	2
<u>P02.05</u>	Multi-function input Command 5 (DI5)	R/W	0205	40518	3
<u>P02.06</u>	Multi-function input Command 6 (DI6)	R/W	0206	40519	4
<u>P02.07</u>	Multi-function input Command 7 (DI7)	R/W	0207	40520	0

Range/Units (Format: 16-bit binary)

- 0: No function
- 1: Multi-step speed command 1
- 2: Multi-step speed command 2
- 3: Multi-step speed command 3
- 4: Multi-step speed command 4
- 5: Reset
- 6: JOG [by external control or GS4-KPD (optional)]
- 7: Acceleration / deceleration speed inhibit
- 8: 1st and 2nd acceleration / deceleration time selection
- 9: 3rd and 4th acceleration / deceleration time selection
- 10: External Fault (EF) Input (P07.20)
- 11: Base Block (B.B.) input from external source
- 12: Output stop
- 13: Cancel the setting of auto-acceleration / auto-deceleration time
- 15: Frequency command from AI1
- 16: Frequency command from AI2
- 18: Force to stop (P07.20)
- 19: Digital up command
- 20: Digital down command
- 21: PID function disabled
- 22: Clear the counter
- 23: Input the counter value (DI6)
- 24: FWD JOG command
- 25: REV JOG command
- 26: TQC / FOC mode selection
- 27: ASR1 / ASR2 selection
- 28: Emergency stop (EF1)
- 29: Signal confirmation for Y-connection
- 30: Signal confirmation for Δ-connection
- 31: High torque bias (P11.30)
- 32: Middle torque bias (P11.31)
- 33: Low torque bias (P11.32)
- 38: Disable writing EEPROM function
- 39: Torque command direction
- 40: Force coasting to stop
- 41: HAND switch
- 42: AUTO switch
- 48: Mechanical gear ratio switch
- 49: Enable drive
- 50: Slave dEb action to execute
- 51: Selection for PLC mode bit 0
- 52: Selection for PLC mode bit 1
- 53: Reserved
- 56: Local / Remote selection
- 58: Enable fire mode (with RUN command)
- 59: Enable fire mode (without RUN command)
- 70: Force auxiliary frequency return to 0
- 71: Disable PID function, force PID output return to 0
- 72: Disable PID function, retain the output value before disabled
- 73: Force PID integral gain return to 0, disable integral
- 74: Reverse PID feedback
- 81: Simple positioning zero point position signal input
- 82: OOB loading balance detection
- 83: Multi-motor (IM) selection bit 0
- 84: Multi-motor (IM) selection bit 1

These parameters select the functions for each digital terminal.

- When $P02.00 = 0$, you can set digital options with multi-function input terminals DI1, DI2.
- When $P02.00 \neq 0$, the multi-function input terminals DI1, DI2 work in accordance with the setting values for P02.00.

Example:

- If $P02.00 = 1$: multi-function input terminal DI1 = FWD / STOP, DI2 = REV / STOP.
- If $P02.00 = 2$: multi-function input terminal DI1 = RUN / STOP, DI2 = FWD / REV.
- When multi-function input terminal DI7 = 0, DI7 is designated as a pulse input terminal.
- If P02.00 is set to three-wire operation control, terminal DI3 is for the STOP contact. The function set previously for this terminal is automatically invalid.

DI7 for Pulse Feedback:

DI7 is set to “0” for pulse feedback. See Group 10 Parameter details for more information.

Summary of Function Settings

Setting	Function	Description
0	No function	
1	Multi-step speed command 1	You can set 15 steps of speed or 15 positions with the digital status of these four terminals. You can use 16-steps of speed if you include the master speed when setting as 15 steps of speed (refer to Parameter Group 04 Multi-step Speed Parameters).
2	Multi-step speed command 2	
3	Multi-step speed command 3	
4	Multi-step speed command 4	
5	Reset	Use this terminal to reset the drive after clearing a drive fault.
6	JOG operation [by external control or GS4-KPD (optional)]	<p>This function is valid when the source of the operation command is the external terminals.</p> <p>The JOG operation executes when the drive stops completely. While running, you can still change the operation direction, and the STOP key on the keypad* and the STOP command from communications are valid. Once the external terminal receives the OFF command, the motor stops in the JOG deceleration time. Refer to P01.20–P01.22 for details.</p> <p>*: This function is valid when P00.32 is set to 1.</p> <p>Mlx: external terminal</p>

Setting	Function	Description
7	Acceleration / deceleration speed inhibit	<p>When you enable this function, the drive stops acceleration or deceleration immediately. After you disable this function, the AC motor drive starts to accelerate or decelerate from the inhibit point.</p>
8	1st and 2nd acceleration / deceleration time selection	<p>You can select the acceleration and deceleration time of the drive with this function, or from the digital status of the terminals; there are four acceleration and deceleration selections.</p>
9	3rd and 4th acceleration / deceleration time selection	
10	External Fault (EF) input (P07.20)	<p>For external fault input. The drive decelerates according to the P07.20 setting, and the keypad shows "EF" (it shows the fault record when an external fault occurs). The drive will begin running again when the fault is cleared (terminal status restored) and RESET is pressed.</p>
11	Base Block (B.B.) input from external	<p>ON: the output of the drive stops immediately. The motor is in free run and the keypad displays the B.B. signal. Refer to P07.08 for details.</p>
12	Output stop	<p>ON: the output of the drive stops immediately, and the motor is in free run status. The drive is in output waiting status until the switch is turned to OFF, and then the drive restarts and runs to the current setting frequency.</p>
13	Cancel the setting of auto-acceleration / auto-deceleration time	<p>Set P01.44 to one of the 01–04 setting modes before using this function. When this function is enabled, OFF is for auto mode and ON is for linear acceleration / deceleration.</p>
15	Rotating speed command from AI1	<p>ON: force the source of the drive's frequency to be AI1. If the rotating speed commands are set to AI1 and AI2 at the same time, the priority is AI1 > AI2.</p>
16	Rotating speed command from AI2	<p>ON: force the source of the drive's frequency to be AI2. If the rotating speed commands are set to AI1 and AI2 at the same time, the priority is AI1 > AI2.</p>
18	Force to stop (P07.20)	<p>ON: the drive ramps to a stop according to the P07.20 setting.</p>

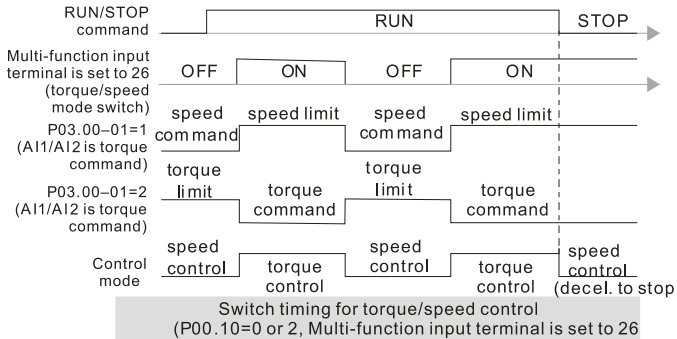
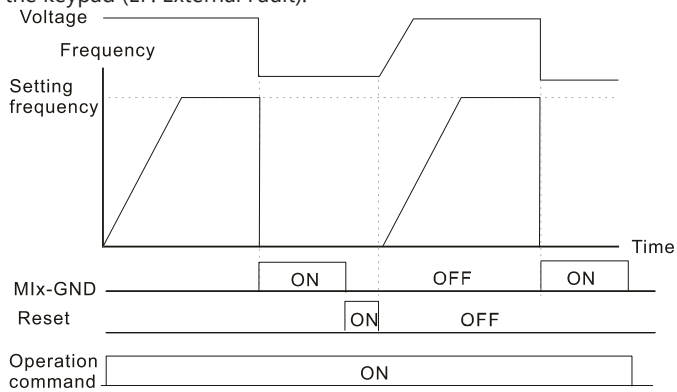
Setting	Function	Description
19	Digital up command	ON: the frequency of the drive increases or decreases by one unit.
20	Digital down command	If this function remains ON continuously, the frequency increases or decreases according to P02.09 / P02.10. The Frequency command returns to zero when the drive stops and the displayed frequency is 0.00 Hz. If you select P11.00, bit 7 = 1, the frequency is not saved.
21	PID function disabled	ON: the PID function is disabled.
22	Clear the counter	ON: the current counter value is cleared and displays 0. The drive counts up when this function is disabled.
23	Input the counter value (DI6)	ON: the counter value increases by one. Use the function with P02.19.
24	FWD JOG command	This function is valid when the source of the operation command is the external terminal. ON: the drive executes forward JOG. When executing the JOG command in torque mode, the drive automatically switches to speed mode. The drive returns to torque mode after the JOG command is complete.
25	REV JOG command	This function is valid when the source of the operation command is the external terminal. ON: the drive executes reverse JOG. When executing the JOG command in torque mode, the drive automatically switches to speed mode. The drive returns to torque mode after the JOG command is complete.
26	TQC / FOC mode selection	ON: TQC mode, OFF: FOC mode.  <p>Switch timing for torque/speed control (P00.10=0 or 2, Multi-function input terminal is set to 26)</p>
27	ASR1 / ASR2 selection	ON: the speed is adjusted by the ASR 2 setting. OFF: the speed is adjusted by the ASR 1 setting. Refer to Pr.11-02 for details.
28	Emergency stop (EF1)	ON: the output of the drive stops immediately, displays "EF1" on the keypad, and the motor is in free run status. The drive remains stopped until the external fault is cleared after you press RESET on the keypad (EF: External Fault). 
29	Signal confirmation for Y-connection	When the control mode is V/F, ON: the drive operates by the first V/F.
30	Signal confirmation for Δ-connection	When the control mode is V/F, ON: the drive operates by the second V/F.

Setting	Function	Description															
31	High torque bias	Refer to P11.30–P11.32 for details.															
32	Middle torque bias																
33	Low torque bias																
38	Disable writing EEPROM function (parameters memory disable)	ON: writing to EEPROM is disabled. Changed parameters are not saved after power off.															
39	Torque command direction	For torque control (P00.10=2), when the torque command is AI1 or AI2, ON: negative torque.															
40	Force coasting to stop	ON: during operation, the motor coasts to stop.															
41	HAND switch	1) When the DI terminal switches to OFF, it executes a STOP command. Therefore, if the DI terminal switches to OFF during operation, the drive stops. 2) Use the optional keypad GS4-KPD to switch between HAND and AUTO. The drive stops first, and then switches to HAND or AUTO status. 3) The optional digital keypad GS4-KPD displays the current status of the drive (HAND / OFF / AUTO).															
42	AUTO switch		<table border="1"> <thead> <tr> <th></th> <th>bit 1</th> <th>bit 0</th> </tr> </thead> <tbody> <tr> <td>OFF</td> <td>0</td> <td>0</td> </tr> <tr> <td>AUTO</td> <td>0</td> <td>1</td> </tr> <tr> <td>HAND</td> <td>1</td> <td>0</td> </tr> <tr> <td>OFF</td> <td>1</td> <td>1</td> </tr> </tbody> </table>		bit 1	bit 0	OFF	0	0	AUTO	0	1	HAND	1	0	OFF	1
	bit 1	bit 0															
OFF	0	0															
AUTO	0	1															
HAND	1	0															
OFF	1	1															
48	Mechanical gear ratio switch	ON: the mechanical gear ratio switches to the second group. Refer to P10.04–P10.07 for details.															
49	Enable drive	When the drive is enabled, the RUN command is valid. When the drive is disabled, the RUN command is invalid. When the drive is operating, the motor coasts to stop. This function varies with a Multifunction Output DO1 or DO2 = 45.															
50	Slave dEb action to execute	Enter the message setting in this parameter when the master triggers dEb. This ensures that the slave also triggers dEb, then the master and slave stop simultaneously.															
51	Selection for PLC mode (bit 0)	<table border="1"> <thead> <tr> <th>PLC Status</th> <th>bit 1</th> <th>bit 0</th> </tr> </thead> <tbody> <tr> <td>Disable PLC function (PLC 0)</td> <td>0</td> <td>0</td> </tr> <tr> <td>Trigger PLC to operate (PLC 1)</td> <td>0</td> <td>1</td> </tr> <tr> <td>Trigger PLC to stop (PLC 2)</td> <td>1</td> <td>0</td> </tr> <tr> <td>No function</td> <td>1</td> <td>1</td> </tr> </tbody> </table>	PLC Status	bit 1	bit 0	Disable PLC function (PLC 0)	0	0	Trigger PLC to operate (PLC 1)	0	1	Trigger PLC to stop (PLC 2)	1	0	No function	1	1
PLC Status	bit 1		bit 0														
Disable PLC function (PLC 0)	0	0															
Trigger PLC to operate (PLC 1)	0	1															
Trigger PLC to stop (PLC 2)	1	0															
No function	1	1															
52	Selection for PLC mode (bit 1)																
56	Local / Remote selection	Use P00.29 to select LOCAL / REMOTE mode. When P00.29 is not set to 0, the optional digital keypad GS4-KPD displays LOC / REM status. (Refer to P00.29 for details). <table border="1"> <thead> <tr> <th></th> <th>bit 0</th> </tr> </thead> <tbody> <tr> <td>REM</td> <td>0</td> </tr> <tr> <td>LOC</td> <td>1</td> </tr> </tbody> </table>		bit 0	REM	0	LOC	1									
	bit 0																
REM	0																
LOC	1																
58	Enable fire mode (with RUN command)	When fire occurs, enable this terminal to make the drive enter the fire mode to force the drive to run. If the drive is in stop status, enable this terminal to make the drive enter the fire mode to force the drive to run according to P06.80 settings. (Refer to P06.80, P06.81, P06.88 for details).															

Setting	Function	Description																											
59	Enable fire mode (without RUN command)	When fire occurs, enable this terminal to make the drive enter the fire mode. If the drive is in stop status, enable this terminal to make the drive enter the fire mode, but the drive does not run. If the drive is in running status, enable this terminal to run the drive according to P06.80 settings. (Refer to P06.80, P06.81, P06.88 for details)																											
70	Force auxiliary frequency return to 0	Forces the auxiliary frequency return to 0 when using this function. PID keeps operating if PID is the master frequency. When P00.35 ≠ 0, the master and auxiliary frequencies are enabled, and then selecting this function with the terminal effectively forces the auxiliary frequency return to 0.																											
71	Disable PID function, force PID output return to 0	When the master and auxiliary frequencies are enabled and when using the PID function, ON: PID does not operate, returns the integral value to 0, and forces the PID output return to 0.																											
72	Disable PID function, retain the output value before disabled	When the master and auxiliary frequencies are enabled, and the PID function is enabled, ON: PID does not operate, and its output value remains the same as the value before it was disabled.																											
73	Force PID integral gain return to 0, disable integral	ON: PID continues to operate, disables the integral control, and returns the integral value to 0.																											
74	Reverse PID feedback	ON: PID negative feedback becomes positive feedback, or PID positive feedback becomes negative feedback.																											
81	Simple positioning zero point position signal input	Use this function as the trigger terminal for simple positioning with P02.78–P02.80. This function is just a simple positioning, so you must verify the positioning accuracy. Refer to P02.80 for details.																											
82	OOB loading balance detection	You can use the OOB (Out Of Balance Detection) function with a PLC program in a washing machine system type application. ON: Parameter P07.48 is calculated according to P07.46 (OOB Sampling Time) and P07.47 (Number of OOB Sampling Times). The PLC or the host controller should be set up to read this parameter and determine the motor's speed according to this Δθ value (P07.48).																											
83	Multi-motor (IM) selection bit 0	ON: parameters can be changed. Example: DI1 = 83, DI2 = 84																											
84	Multi-motor (IM) selection bit 1																												
<table border="1"> <thead> <tr> <th rowspan="2">DI1</th> <th rowspan="2">DI2</th> <th rowspan="2">Motor Selection</th> <th colspan="2">Related Motor Parameter</th> </tr> <tr> <th>Max Operation Frequency</th> <th>V/F Curve Parameters</th> </tr> </thead> <tbody> <tr> <td>OFF</td> <td>OFF</td> <td>Motor 1</td> <td>P01.00</td> <td>P01.01–P01.08</td> </tr> <tr> <td>ON</td> <td>OFF</td> <td>Motor 2</td> <td>P01.52</td> <td>P01.35–P01.42</td> </tr> <tr> <td>OFF</td> <td>ON</td> <td>Motor 3</td> <td>P01.53</td> <td>P01.54–P01.61</td> </tr> <tr> <td>ON</td> <td>ON</td> <td>Motor 4</td> <td>P01.62</td> <td>P01.63–P01.70</td> </tr> </tbody> </table>			DI1	DI2	Motor Selection	Related Motor Parameter		Max Operation Frequency	V/F Curve Parameters	OFF	OFF	Motor 1	P01.00	P01.01–P01.08	ON	OFF	Motor 2	P01.52	P01.35–P01.42	OFF	ON	Motor 3	P01.53	P01.54–P01.61	ON	ON	Motor 4	P01.62	P01.63–P01.70
DI1	DI2	Motor Selection				Related Motor Parameter																							
			Max Operation Frequency	V/F Curve Parameters																									
OFF	OFF	Motor 1	P01.00	P01.01–P01.08																									
ON	OFF	Motor 2	P01.52	P01.35–P01.42																									
OFF	ON	Motor 3	P01.53	P01.54–P01.61																									
ON	ON	Motor 4	P01.62	P01.63–P01.70																									

	Type	Hex Addr	Dec Addr
P02.09 UP / DOWN Key Mode	◆R/W	0209	40522
<i>Range/Units (Format: 16-bit binary)</i>	<i>Default</i>		
0: UP / DOWN by the acceleration / deceleration time	0		
1: UP / DOWN constant speed (P02.10)			
2: Pulse signal (P02.10)			
3: External terminals UP / DOWN key mode			

	Type	Hex Addr	Dec Addr
P02.10 Constant Speed, Acceleration / Deceleration Speed of the UP / DOWN Key	◆R/W	020A	40523
<i>Range/Units (Format: 16-bit unsigned)</i>	<i>Default</i>		
0.001–1.000 Hz / ms	0.001		

These parameters are used when the multi-function input terminals are set to 19, 20 (Digital UP / DOWN command). The frequency increases or decreases according to P02.09 and P02.10.

- When P11.00 bit 7 = 1, the frequency is not saved. The Frequency command returns to zero when the drive stops, and the displayed frequency is 0.00 Hz. At this time, increasing or decreasing the Frequency command (F) by using the UP or DOWN key is valid only when the drive is running.
- When P02.09 is set to 0, the increasing or decreasing Frequency command (F) operates according to the setting for acceleration or deceleration time (refer to P01.12–P01.19).

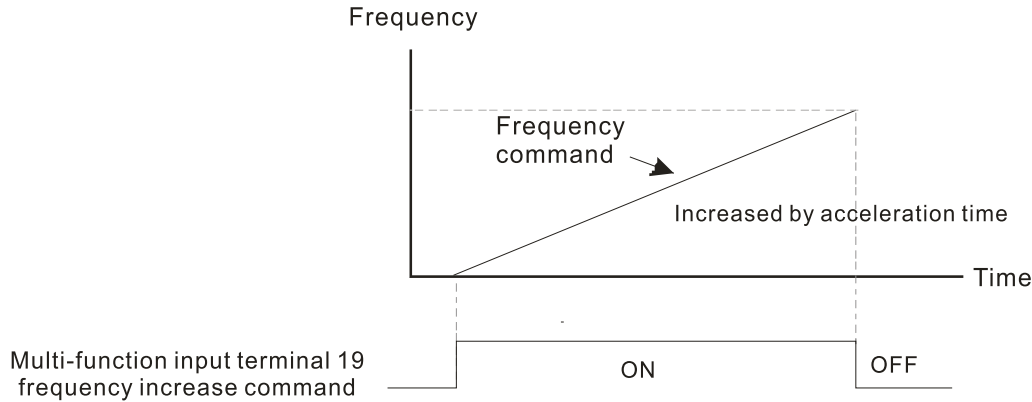

- When P02.09 is set to 1, the increasing or decreasing Frequency command (F) operates according to the setting of P02.10 (0.001–1.000 Hz/ms).

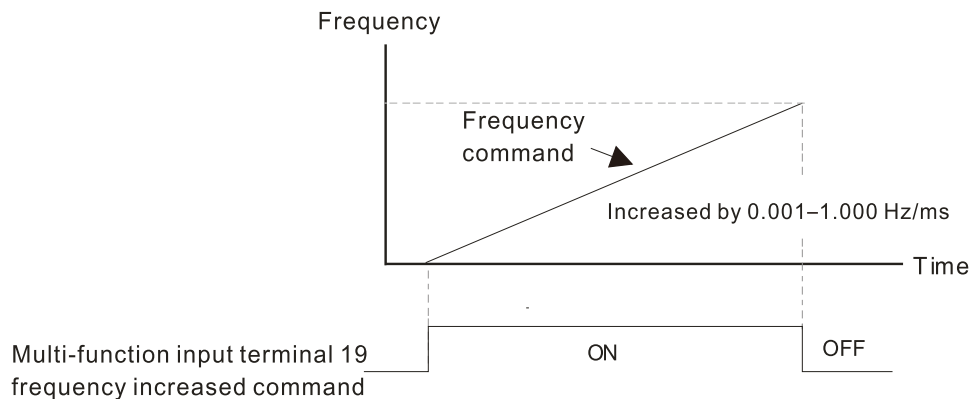

	Type	Hex Addr	Dec Addr
P02.11 Multi-function Input Response Time	◆R/W	020B	40524
<i>Range/Units (Format: 16-bit unsigned)</i>	<i>Default</i>		
0.000–30.000 sec.	0.005		

Use P02.11 to set the response time of the digital input terminals DI1–DI7.

This function is to delay and confirm the digital input terminal signal. The time for delay is also the time for confirmation. The confirmation prevents interference that could cause error in the input to the digital terminals. It delays the response time though confirmation to improve accuracy.

	Type	Hex Addr	Dec Addr
P02.12 Multi-function Input Mode Selection	◆R/W	020C	40525
<i>Range/Units (Format: 16-bit unsigned)</i>	<i>Default</i>		
0000h–FFFFh (0: N.O.; 1: N.C.)	0000		

The parameter value will be displayed/entered in decimal format on the drive keypad or in GSoft2. If using the GS4-KPD, the value will be displayed/entered in hexadecimal format. This parameter sets the status of the multi-function input signal (0: normally open, 1: normally closed) and it is not affected by the status of SINK / SOURCE.

- bit 0–bit 6 correspond to DI1–DI7.
- The default for bit 0 (DI1) is FWD terminal, and the default for bit 1 (DI2) is REV terminal. You cannot use this parameter to change the input mode when P02.00 ≠ 0.
- You can change the terminal ON / OFF status through communications.
- For example: DI3 is set to 1 (multi-step speed command 1) and DI4 is set to 2 (multi-step speed command 2). Then the forward + second step speed command = 1001 (binary) = 9 (decimal). As long as P02.12 = 9 is set through communications, there is no need to wire any multi-function terminal to run forward with the second step speed.

bit 6	bit 5	bit 4	bit 3	bit 2	bit 1	bit 0
DI7	DI6	DI5	DI4	DI3	DI2	DI1

- Use P11.42 bit 1 to select whether FWD / REV terminal is controlled by P02.12 bit 0 and bit 1.

	Type	Hex Addr	Dec Addr	Default
P02.13 Multi-function Output 1 (R1)	◆R/W	020D	40526	11
P02.16 Multi-function Output 2 (DO1)	◆R/W	0210	40529	0
P02.17 Multi-function Output 3 (DO2)	◆R/W	0211	40530	0

Range/Units (Format: 16-bit binary)

- 0: No function
- 1: Indication during RUN
- 2: Operation speed reached
- 3: Desired frequency reached 1 (P02.22)
- 4: Desired frequency reached 2 (P02.24)
- 5: Zero speed (Frequency command)
- 6: Zero speed including STOP (Frequency command)
- 7: Over-torque 1 (P06.06–06.08)
- 8: Over-torque 2 (P06.09–06.11)
- 9: Drive is ready
- 10: Low voltage warning (Lv) (P06.00)
- 11: Malfunction indication
- 13: Overheat warning (P06.15)
- 14: Software brake signal indicator (P07.00)
- 15: PID feedback error (P08.13, P08.14)
- 16: Slip error (oSL)
- 17: Count value reached, does not return to 0 (P02.20)
- 18: Count value reached, return to 0 (P02.19)
- 19: External interrupt B.B. input (Base Block)
- 20: Warning output
- 21: Over-voltage
- 22: Over-current stall prevention
- 23: Over-voltage stall prevention
- 24: Operation mode
- 25: Forward command
- 26: Reverse command
- 29: Output when frequency ≥ P02.34
- 30: Output when frequency < P02.34
- 31: Y-connection for the motor coil
- 32: Δ-connection for the motor coil
- 33: Zero speed (actual output frequency)
- 34: Zero speed including STOP (actual output frequency)
- 35: Error output selection 1 (P06.23)
- 36: Error output selection 2 (P06.24)
- 37: Error output selection 3 (P06.25)
- 38: Error output selection 4 (P06.26)
- 40: Speed reached (including STOP)
- 42: Crane function
- 43: Motor speed detection
- 44: Low current output (use with P06.71–06.73)
- 45: UVW output electromagnetic valve switch
- 46: Master dEb output
- 51: Digital output control for serial modbus
- 52: Digital output control for communication card
- 53: Fire mode indication
- 66: SO output logic A
- 67: Analog input level reached
- 68: SO output logic B
- 73: Over-torque 3
- 74: Over-torque 4
- 75: Forward RUN status
- 76: Reverse RUN status

Use these parameters to set the function of multi-function terminals.

Summary of Function Settings

Setting	Function	Description
0	No Function	Output terminal with no function
1	Indication during RUN	Activates when the drive is not in STOP.
2	Operation speed reached	Activates when output frequency of drive reaches to the setting frequency.
3	Desired frequency reached 1 (P02.22)	Activates when the desired frequency (P02.22) is reached.
4	Desired frequency reached 2 (P02.24)	Activates when the desired frequency (P02.24) is reached.
5	Zero speed (Frequency command)	Activates when Frequency command = 0. (the drive must be in RUN status)
6	Zero speed including STOP (Frequency command)	Activates when Frequency command = 0 or stopped.
7	Over-torque 1	Activates when the drive detects over-torque. P06.07 sets the over-torque detection level (motor 1), and P06.08 sets the over-torque detection time (motor 1). Refer to P06.06–P06.08.
8	Over-torque 2	Activates when the drive detects over-torque. P06.10 sets the over-torque detection level (motor 2), and P06.11 sets the over-torque detection time (motor 2). Refer to P06.09–P06.11.
9	Drive is ready	Activates when the drive is ON with no error detected.
10	Low voltage warning (Lv)	Activates when the DC bus voltage is too low. (refer to P06.00 Low Voltage Level)
11	Malfunction indication	Activates when fault occurs (except Lv stop).
13	Overheat warning	Activates when IGBT or heat sink overheats to prevent the drive from shutting down due to overheating. (refer to P06.15)
14	Software brake signal indication	Activates when the soft brake function is ON. (refer to P07.00).
15	PID feedback error (P08.13, P08.14)	Activates when the PID feedback signal error is detected.
16	Slip error (oSL)	Activates when the slip error is detected.
17	Count value reached, does not return to 0 (P02.20)	When the drive executes external counter, this contact activates if the count value is equal to the setting value for P02.20. This contact deactivates when the setting value for P02.20 > P02.19.
18	Count value reached, returns to 0 (P02.19)	When the drive executes the external counter, this contact activates if the count value is equal to the setting value for P02.19.
19	External interrupt B.B. input (Base Block)	Activates when external interrupt (B.B.) stop output occurs in the drive.
20	Warning output	Activates when a warning is detected.
21	Over-voltage	Activates when over-voltage is detected.
22	Over-current stall prevention	Activates when the over-current stall prevention is detected.
23	Over-voltage stall prevention	Activates when over-voltage stall prevention is detected.
24	Operation mode	Activates when the source of operation command is not controlled by the digital keypad (P00.21 ≠ 0).
25	Forward command	Activates when the operation direction is forward.
26	Reverse command	Activates when the operation direction is reverse.
29	Output when frequency ≥ P02.34	Activates when frequency is ≥ P02.34 (actual output H ≥ P02.34).
30	Output when frequency < P02.34	Activates when frequency is < P02.34 (actual output H < P02.34).
31	Y-connection for the motor coil	Activates when P05.24 = 1, the frequency output is lower than P05.23 minus 2 Hz and the time is longer than P05.25.
32	Δ-connection for the motor coil	Activates when P05.24 = 1, the frequency output is higher than P05.23 plus 2 Hz and the time is longer than P05.25.

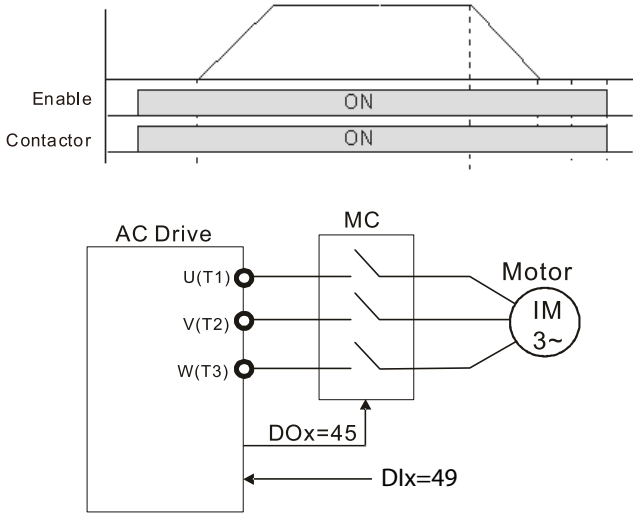
Setting	Function	Description																
33	Zero speed (actual output frequency)	Activates when the actual output frequency is 0 (the drive is in RUN mode).																
34	Zero speed including stop (actual output frequency)	Activates when the actual output frequency is 0 or stopped.																
35	Error output selection 1 (P06.23)	Activates when P06.23 is ON.																
36	Error output selection 2 (P06.24)	Activates when P06.24 is ON.																
37	Error output selection 3 (P06.25)	Activates when P06.25 is ON.																
38	Error output selection 4 (P06.26)	Activates when P06.26 is ON.																
40	Speed reached (including Stop)	Activates when the drive's output frequency reaches the setting frequency or stopped.																
42	Crane function	Use this function with P02.34 and P02.58. Refer to P02.34 and P02.58 for details and application examples.																
43	Actual motor speed detection	Activates when using the DI7 as pulse input signal and motor actual speed is less than P02.47.																
44	Low current output	Use this function with P06.71–P06.73.																
45	UVW output electromagnetic valve switch	Use this function with any multifunction input = 49 (drive enabled) and multifunction output = 45 (electromagnetic valve enabled), and then the electromagnetic valve is ON or OFF according to the status of the drive. 																
46	Master dEb output	When dEb rises at the master, DO1 or DO2 sends a dEb signal to the slave. Output the message when the master triggers dEb. This ensures that the slave also triggers dEb. Then the slave follows the deceleration time of the master to stop simultaneously with the master.																
51	Digital output control for serial modbus	Control the digital outputs through communications(51= Serial Modbus, 52 = GS20A-CM-ENETIP). Use Register 2640 to set the Output value.																
52	Digital output control for communication card	<table border="1"> <thead> <tr> <th>Physical terminal</th> <th>Parameter Setting</th> <th>Attribute</th> <th>Corresponding index</th> </tr> </thead> <tbody> <tr> <td>R1</td> <td>P02.13 = 51 or 52</td> <td>RW</td> <td>bit 0 of 2640</td> </tr> <tr> <td>DO1</td> <td>P02.16 = 51 or 52</td> <td>RW</td> <td>bit 3 of 2640</td> </tr> <tr> <td>DO2</td> <td>P02.17 = 51 or 52</td> <td>RW</td> <td>bit 4 of 2640</td> </tr> </tbody> </table>	Physical terminal	Parameter Setting	Attribute	Corresponding index	R1	P02.13 = 51 or 52	RW	bit 0 of 2640	DO1	P02.16 = 51 or 52	RW	bit 3 of 2640	DO2	P02.17 = 51 or 52	RW	bit 4 of 2640
Physical terminal	Parameter Setting	Attribute	Corresponding index															
R1	P02.13 = 51 or 52	RW	bit 0 of 2640															
DO1	P02.16 = 51 or 52	RW	bit 3 of 2640															
DO2	P02.17 = 51 or 52	RW	bit 4 of 2640															
53	Fire mode indication	Activates when DI setting 58 or 59 is enabled.																

Setting	Function	Description		
66	SO output logic A	Status of the drive	Status of the safety output	
			Status A (DOx = 66)	Status B (DOx = 68)
		Normal	0	1
68	SO output logic B	STO	1	0
		STL1–STL3	1	0
67	Analog input level reached	The multi-function output terminals operate when the analog input level is between the high level and the low level. P03.44: Select one of the analog input channels (AI1, AI2) to be compared. P03.45: The high level for the analog input, default is 50%. P03.46: The low level for the analog input, default is 10%. If analog input > P03.45, the multi-function output terminal operates. If analog input < P03.46, the multi-function output terminal stops output.		
73	Over-torque 3	Activates when over-torque is detected. P14.75 sets the over-torque detection level. P14.76 sets the over-torque detection time (refer to P14.74–P14.76).		
74	Over-torque 4	Activates when over-torque is detected. P14.78 sets the over-torque detection level. P14.79 sets the over-torque detection time (refer to P14.77–P14.79).		
75	Forward RUN status	When the drive runs FWD, the output terminal for forward running is closed; when the drive stops, the output terminal for forward running is open.		
76	Reverse RUN status	When the drive runs REV, the output terminal for reverse running is closed; when the drive stops, the output terminal for reverse running is open.		

P02.18 Multi-function Output Direction

Range/Units (Format: 16-bit unsigned)
0000h–FFFFh (0:N.O.; 1:N.C.)

Type	Hex Addr	Dec Addr
◆R/W	0212	40531
<i>Default</i>		
	0000h	

The parameter value will be displayed/entered in decimal format on the drive keypad or in GSoft2. If using the GS4-KPD, the value will be displayed/entered in hexadecimal format. This parameter is set by a bit. If the bit is 1, the corresponding multi-function output acts in an opposite way.

Example:

Assume P02.13 = 1. If the output is positive, and the bit is set to 0, then the Relay is ON when the drive runs and is OFF when the drive stops. Conversely, if the output is negative, and the bit is set to 1, then the Relay is OFF when the drive runs and is ON when the drive stops.

bit 4	bit 3	bit 2	bit 1	bit 0
DO2	DO1	Reserved	Reserved	R1



NOTE: Use this parameter to set digital outputs ON/OFF with remote communications.

P02.19 Terminal Counting Value Reached (returns to 0)

Range/Units (Format: 16-bit unsigned)
0–65500

Type	Hex Addr	Dec Addr
◆R/W	0213	40532
<i>Default</i>		
	0	

The counting function is enabled when P02.19≠0.

- You can set the input point for the counter using the multifunction input terminal DI6 as a trigger terminal (set P02.06 to 23). When counting is completed, the specified multi-function output terminal is activated (P02.13, P02.16, or P02.17 is set to 18).
- The timing diagram below shows that when counting to 5, R1 activates and displays 0.

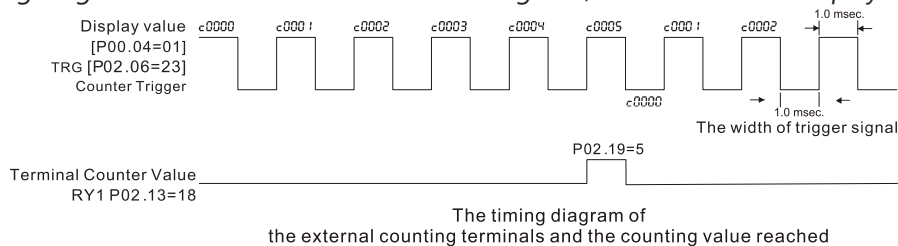

P02.20 Preliminary Counting Value Reached (does not return to 0)

Range/Units (Format: 16-bit unsigned)
0–65500

Type	Hex Addr	Dec Addr
◆R/W	0214	40533
<i>Default</i>		
	0	

Use this parameter in conjunction with P02.19.

- When the count value counts from 1 to reach this value, the corresponding multi-function output terminal is activated (P02.13, P02.16, or P02.17 is set to 17) and keeps counting to the last count value.
- Use this parameter as the end of counting to make the drive run from the low speed to stop.
- The timing diagram is R1 activates when the count value is three, and the display returns to zero when counts to five:

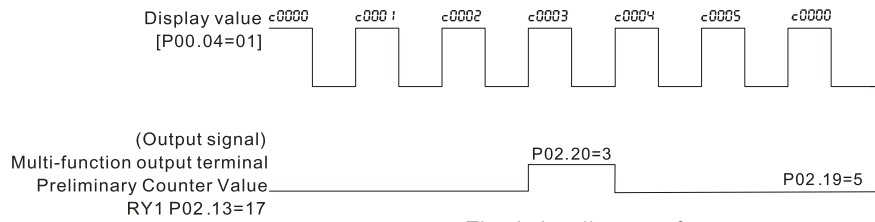

The timing diagram of the external counting terminals and the counting value reached

P02.21 Digital Output Gain (DO)

Range/Units (Format: 16-bit unsigned)
1–55

Type	Hex Addr	Dec Addr
◆R/W	0215	40534
<i>Default</i>		
	1	

P02.21 sets the signal for the digital output terminals (DO-DCM) and the digital frequency output (pulse, work period=50 %). The output pulse per second = output frequency X P02.21.

P02.22 Desired Frequency Reached 1

P02.23 The Width of the Desired Frequency Reached 1

P02.24 Desired Frequency Reached 2

P02.25 The Width of the Desired Frequency Reached 2

Range/Units (Format: 16-bit unsigned)
0.00–599.00 Hz

Type	Hex Addr	Dec Addr	Default
◆R/W	0216	40535	60.00/50.00
◆R/W	0217	40536	2.00
◆R/W	0218	40537	60.00/50.00
◆R/W	0219	40538	2.00

Use these parameters to close multi-function output terminals when the specified conditions are met. Once the output speed (frequency) reaches the desired speed (frequency), if the corresponding multi-function output terminal is set to 3 or 4 (P02.13, P02.16, and P02.17), this multi-function output terminal is “closed”.

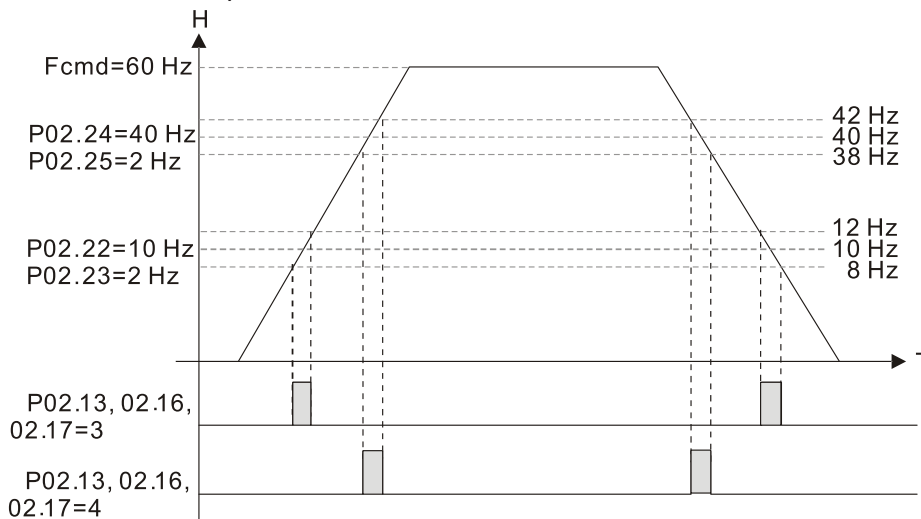

P02.34 Output Frequency Setting for Multi-function Output Terminal

P02.58 Multi-function Output Terminal (Function 42): Brake Frequency Check Point

Range/Units (Format: 16-bit unsigned)
0.00–599.00 Hz

Type	Hex Addr	Dec Addr
◆R/W	0222	40547
◆R/W	023A	40571
<i>Default</i>		
	0.00	

Use P02.34 with P02.58 for the crane function. Configure multifunction outputs P02.14, P02.16, and/or P02.17 with a terminal setting of 42: Crane function.

- When the output frequency (H) is lower than the setting for P02.58, multi-function output terminal setting 42 stops after the command breaks off.
- P02.58 must be lower than P02.34 when using multifunction output terminal setting=42.

Crane application example:

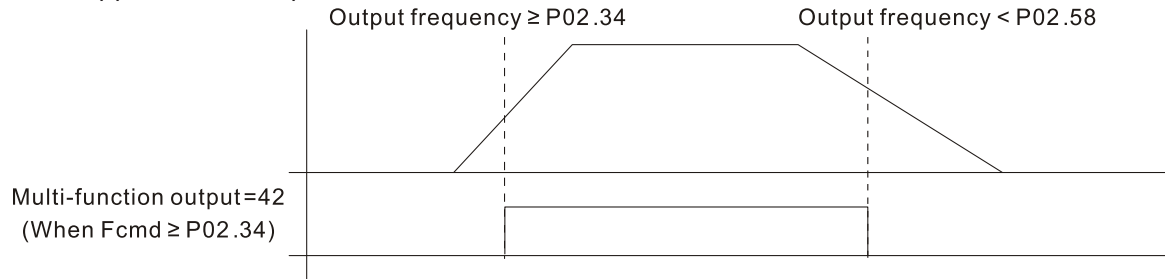

It is recommended that you use this with the Dwell acceleration/deceleration function as shown in the following diagram.

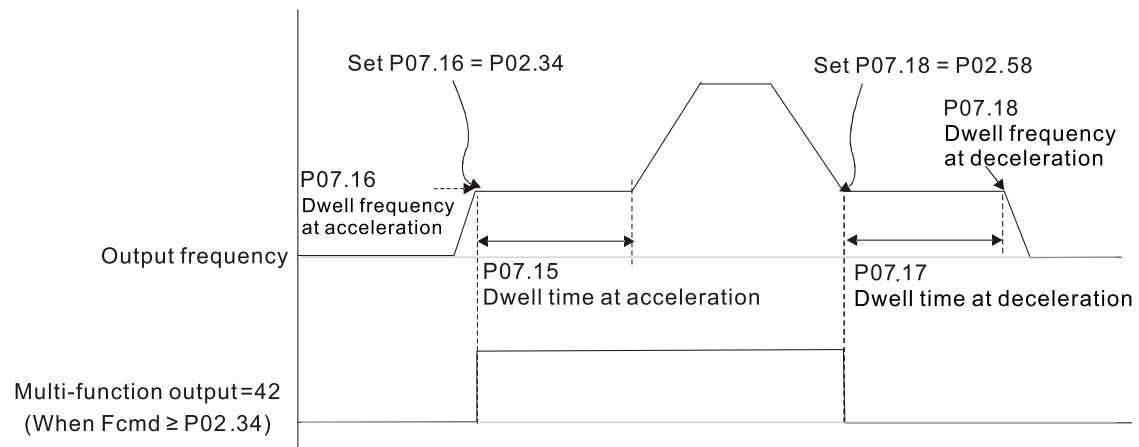

	Type	Hex Addr	Dec Addr
P02.35 External Operation Control Selection after Reset and Reboot	◆R/W	0223	40548
<i>Range/Units (Format: 16-bit binary)</i>	<i>Default</i>		
0: Disable	0		
1: Drive runs if the RUN command remains after reset or reboot.			

P02.35 allows the drive to resume running after a reset or reboot if an external control is still commanding it to RUN.

Setting value 1:

- Situation 1: After the drive is powered up and the external terminal for RUN stays ON, the drive runs.
- Situation 2: After clearing a detected fault and while the external terminal for RUN stays ON, you can run the drive by pressing the RESET key.

P02.47	Motor Zero-speed Level	Type	Hex Addr	Dec Addr
	<i>Range/Units (Format: 16-bit unsigned)</i>	◆R/W	022F	40560
	0–65535 rpm	Default		
			0	

Use this parameter with multifunction output=43 and set P10.00=5. Use this parameter to set the motor’s speed level to zero-speed. When the actual speed is lower than this setting, the corresponding multi-function output terminal setting 43 is ON, as shown in the diagram below.

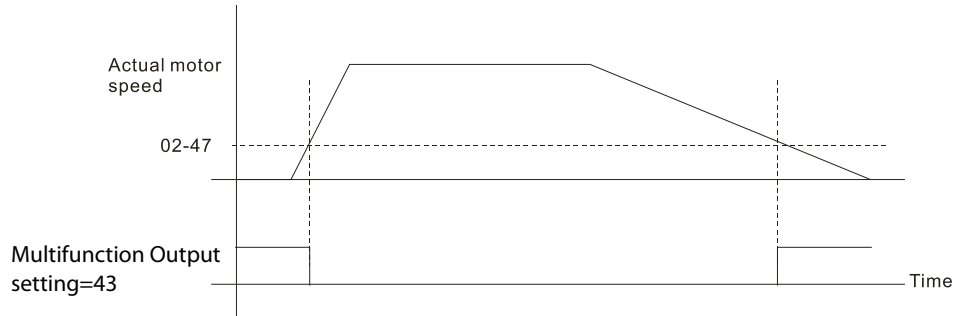

P02.50	Display the Status of Multi-function Input Terminal	Type	Hex Addr	Dec Addr
	<i>Range/Units (Format: 16-bit unsigned)</i>	Read	0232	40563
	Monitor the status of the Multi-function Input Terminal	Default		
			0	

P02.50 displays the status of the multi-function input terminals. Use the diagram below to interpret the display. The value will display in decimal on the keypad and must be converted to binary.

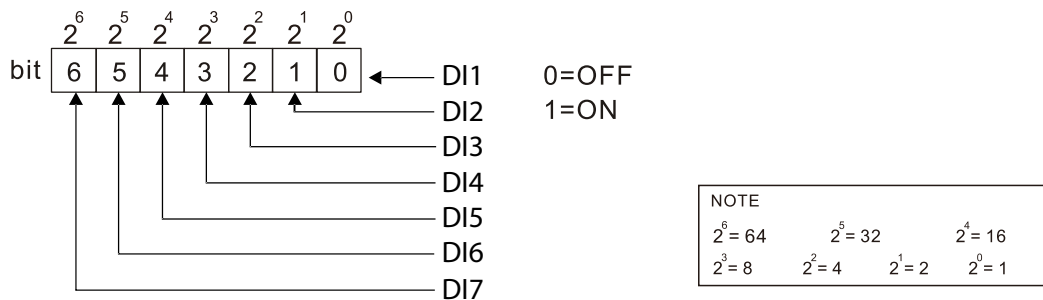

Example:

When P02.50 displays 0034h (hex) (52 (decimal) and 0110100 (binary)), it means that DI3, DI5 and DI6 are ON.

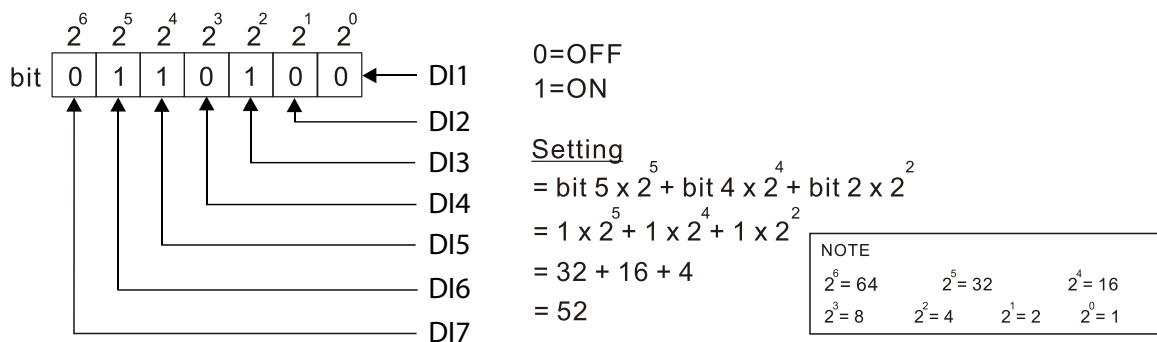

P02.51 Display the Status of Multi-function Output Terminal

Range/Units (Format: 16-bit unsigned)

Monitor the status of the Multi-function Output Terminal

Type	Hex Addr	Dec Addr
Read	0233	40564
Default		

0

P02.51 displays the status of the multi-function output terminals. Use the diagram below to interpret the display. The value will display in decimal on the keypad and must be converted to binary.

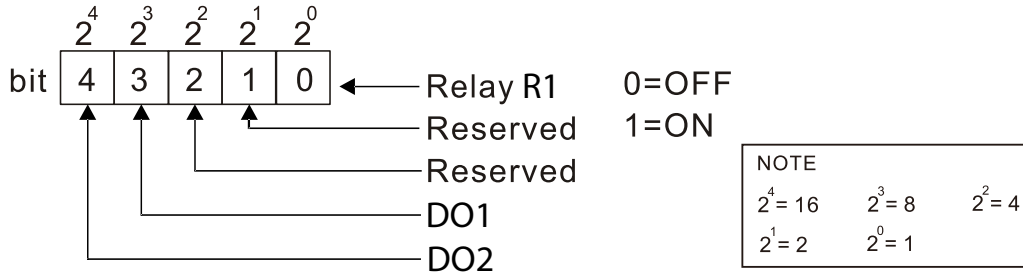

Example:

When P02.51 displays 0009h (hex) (9 (decimal) and 01001 (binary)), it means that Relay R1 and DO1 are ON.

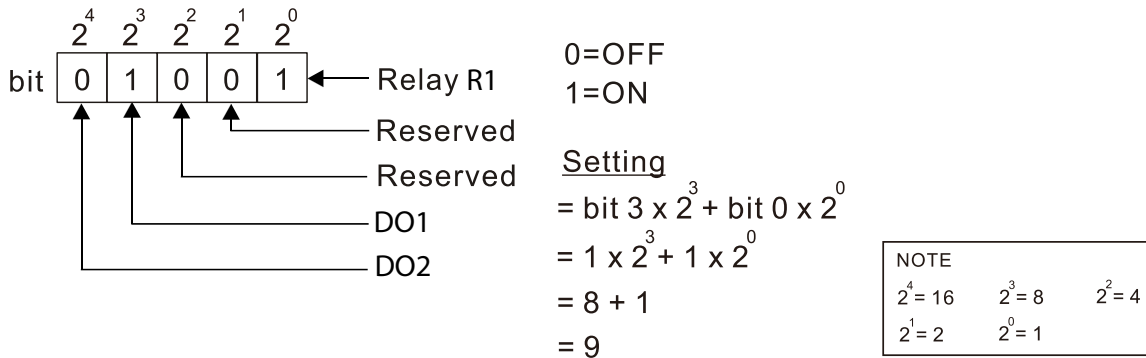

P02.52 Display the External Multi-function Input Terminals Used by PLC

Range/Units (Format: 16-bit unsigned)

Monitor which inputs are controlled by the PLC

Type	Hex Addr	Dec Addr
Read	0234	40565
Default		

0

P02.52 displays the mask status of the PLC input terminals. These values indicate if the input is controlled by the PLC or drive. Use the diagram below to interpret the display. The value will display in decimal on the keypad and must be converted to binary.

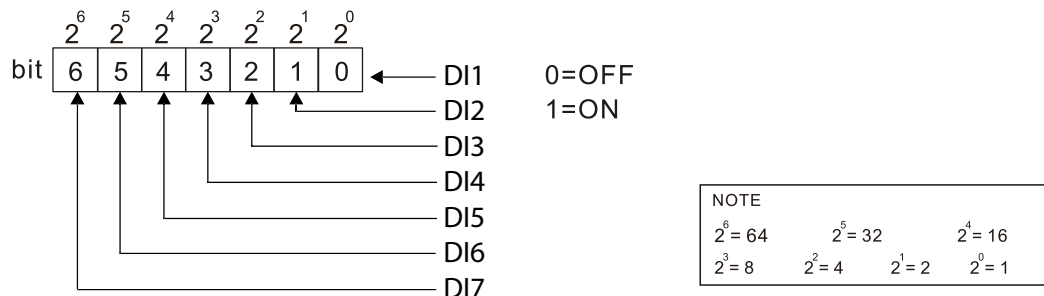

Example:

When P02.52 displays 0034h (hex) (52 (decimal) and 0110100 (binary)), it means that DI3, DI5 and DI6 are used by PLC.

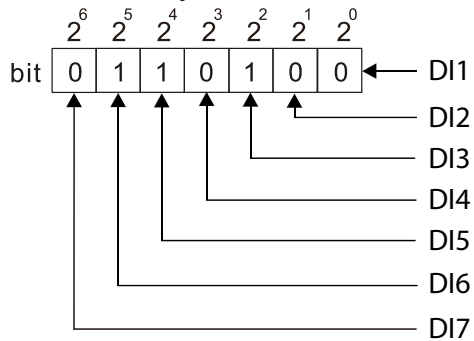

0=OFF
1=ON

Setting

$$\begin{aligned}
 &= \text{bit } 5 \times 2^5 + \text{bit } 4 \times 2^4 + \text{bit } 2 \times 2^2 \\
 &= 1 \times 2^5 + 1 \times 2^4 + 1 \times 2^2 \\
 &= 32 + 16 + 4 \\
 &= 52
 \end{aligned}$$

NOTE			
$2^6 = 64$	$2^5 = 32$	$2^4 = 16$	
$2^3 = 8$	$2^2 = 4$	$2^1 = 2$	$2^0 = 1$

	Type	Hex Addr	Dec Addr
P02.53 <i>Display the External Multi-function Output Terminals Used by PLC</i>	Read	0235	40566
<i>Range/Units (Format: 16-bit unsigned)</i>	Default		0
Monitor which outputs are controlled by the PLC			

P02.53 displays the mask status of the PLC output terminals. These values indicate if the output is controlled by the PLC or Drive. Use the diagram below to interpret the display. The value will display in decimal on the keypad and must be converted to binary.

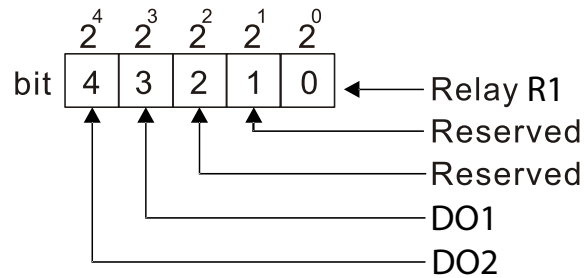

0=OFF
1=ON

NOTE		
$2^4 = 16$	$2^3 = 8$	$2^2 = 4$
$2^1 = 2$	$2^0 = 1$	

Example:

When P02.53 displays 0009h (hex) (9 (decimal) and 01001 (binary)), it means that Relay R1 and DO1 are used by PLC.

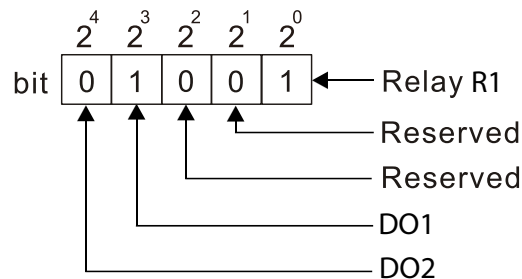

0=OFF
1=ON

Setting

$$\begin{aligned}
 &= \text{bit } 3 \times 2^3 + \text{bit } 0 \times 2^0 \\
 &= 1 \times 2^3 + 1 \times 2^0 \\
 &= 8 + 1 \\
 &= 9
 \end{aligned}$$

NOTE		
$2^4 = 16$	$2^3 = 8$	$2^2 = 4$
$2^1 = 2$	$2^0 = 1$	

	Type	Hex Addr	Dec Addr
P02.54 Display the Frequency Command Executed by External Terminal	Read	0236	40567
<u>Range/Units (Format: 16-bit unsigned)</u>	<u>Default</u>		
0.00–599.00 Hz (Read only)	0		

When you set the source of the Frequency command as the external terminal, if LV or Fault occurs, the external terminal Frequency command is saved in this parameter.

	Type	Hex Addr	Dec Addr
P02.78 Motor Deceleration Ratio	R/W	024E	40591
<u>Range/Units (Format: 16-bit unsigned)</u>	<u>Default</u>		
4.0–1000.0	200.0		

	Type	Hex Addr	Dec Addr
P02.79 Automatic Positioning Angle Setting	R/W	024F	40592
<u>Range/Units (Format: 16-bit unsigned)</u>	<u>Default</u>		
0.0–6480.0	180.0		

	Type	Hex Addr	Dec Addr
P02.80 Automatic Positioning Deceleration Time	◆R/W	0250	40593
<u>Range/Units (Format: 16-bit unsigned)</u>	<u>Default</u>		
0.00: Disable the function 0.01–100.00 sec.	0.00		

- Automatic positioning function is disabled when P02.80=0.00.
- Use this parameter with the multi-function input terminal setting 81 (Simple positioning zero point position signal input) to complete the positioning setting for application.
- t_f automatically generates according to the positioning angle. $\Delta t = P02.80$. The gross area ($t_f + \Delta t$) is the required distance of the positioning.

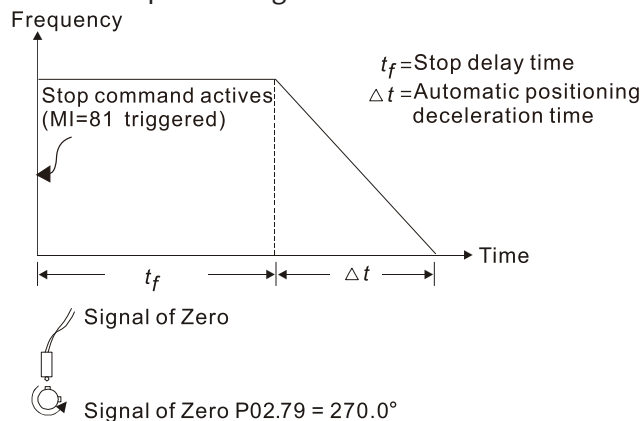

	Type	Hex Addr	Dec Addr
P02.81 EF Activates when the Terminal Count Value Reached	◆R/W	0251	40594
<u>Range/Units (Format: 16-bit binary)</u>	<u>Default</u>		
0: Terminal count value reached, no EF displays (continues to operate) 1: Terminal count value reached, EF activates	0		

	Type	Hex Addr	Dec Addr
P02.82 Initial Frequency Command (F) Mode after Stop	◆R/W	0252	40595
<u>Range/Units (Format: 16-bit binary)</u>	<u>Default</u>		
0: Use current Frequency command 1: Use zero Frequency command 2: Refer to P02.83 to set up	0		

	Type	Hex Addr	Dec Addr
P02.83 Initial Frequency Command (F) Setting after Stop	◆R/W	0253	40596
<i>Range/Units (Format: 16-bit unsigned)</i>	<i>Default</i>		
0.00–599.00 Hz	60.00		

GROUP P03.xx DETAILS – ANALOG INPUT/OUTPUT PARAMETERS

	Type	Hex Addr	Dec Addr	Default
P03.00 Analog Input Selection (AI1)	◆R/W	0300	40769	1
P03.01 Analog Input Selection (AI2)	◆R/W	0301	40770	0

Range/Units (Format: 16-bit binary)

- 0: No function
- 1: Frequency command
- 2: Torque command (torque limit under speed mode)
- 3: Torque compensation command
- 4: PID target value
- 5: PID feedback signal
- 6: Thermistor (PTC) input value
- 7: Positive torque limit
- 8: Negative torque limit
- 9: Regenerative torque limit
- 10: Positive / negative torque limit
- 11: PT100 RTD input value
- 12: Auxiliary frequency input
- 13: PID compensation value

When using the analog input as the PID reference target, you must set P00.20 to 2 (external analog input).

- Setting method 1: P03.00–P03.01 set 1 as PID reference target input.
- Setting method 2: P03.00–P03.01 set 4 as PID reference target input.

If both setting value 1 and 4 are input, the AI1 input has highest priority to become the PID reference target input value.

- When you use analog input as the PID compensation value, you must set P08.16 to 1 (source of PID compensation value is analog input). You can see the compensation value with P08.17.
- When using the Frequency command, the corresponding value for 0–10 V / 4–20 mA is 0–maximum operation frequency (P01.00).
- When using the torque command, the corresponding value for 0–10 V / 4–20 mA is 0–maximum output torque (P11.27).
- When using torque compensation, the corresponding value for 0–10 V / 4–20 mA is 0–the motor's rated torque.
- If the settings for P03.00–P03.01 are the same, the AI1 input has priority over the AI2 input.
- For use of Selection 2 as Torque limit, a multifunction input must be set to value 26 (TQC/FOC mode selection) to toggle between Torque command and Torque limit mode.

	Type	Hex Addr	Dec Addr
P03.03 Analog Input Bias (AI1)	◆R/W	0302	40771
<i>Range/Units (Format: 16-bit signed)</i>	<i>Default</i>		
-100.0–100.0 %	0		

P03.03 sets the corresponding AI1 voltage for the external analog input. P03.50 must be set to zero for this parameter to be active. See analog input examples at the end of this section for further explanation of bias/gain settings.

	Type	Hex Addr	Dec Addr
P03.04 Analog Input Bias (AI2)	◆R/W	0303	40772
<i>Range/Units (Format: 16-bit signed)</i>	<i>Default</i>		
-100.0–100.0 %	0		

P03.04 sets the corresponding AI2 voltage for the external analog input. P03.50 must be set to zero for this parameter to be active. See analog input examples at the end of this section for further explanation of bias/gain settings.

	Type	Hex Addr	Dec Addr
P03.07 Positive / Negative Bias Mode (AI1)	◆R/W	0304	40773
P03.08 Positive / Negative Bias Mode (AI2)	◆R/W	0308	40777
<i>Range/Units (Format: 16-bit binary)</i>	<i>Default</i>		
0: No bias	0		
1: Lower than or equal to bias			
3: The absolute value of the bias voltage while serving as the center			
4: Bias serves as the center			

Using negative bias to set the frequency greatly reduces noise interference. In a noisy environment, do NOT use signals less than 1V to set the drive’s operation frequency. P03.50 must be set to zero for these parameters to be active. See analog input examples at the end of this section for further explanation of bias/gain settings.

	Type	Hex Addr	Dec Addr
P03.10 Reverse Setting when Analog Signal Input is Negative Frequency	◆R/W	030A	40779
<i>Range/Units (Format: 16-bit binary)</i>	<i>Default</i>		
0: Negative frequency input is not allowed. The digital keypad or external terminal controls the forward and reverse direction.	0		
1: Negative frequency input is allowed. Positive frequency = run in a forward direction; negative frequency = run in a reverse direction. The digital keypad or external terminal control cannot change the running direction.			

Use this parameter only for AI1 or AI2 analog input.

Requirements for negative frequency (reverse running):

- 1) P03.10 = 1
- 2) P03.07/P03.08 Bias mode = 4: Bias serves as the center
- 3) P03.11/P03.12 analog input gain < 0 (negative); this makes the input frequency negative. When using the analog input addition function (P03.18=1), if the analog signal is negative after the addition, you can set this parameter to allow or not allow the reverse running. The result after adding depends on the “Requirements for negative frequency (reverse running)”.

P03.50 must be set to zero for this parameter to be active.

See analog input examples at the end of this section for further explanation of bias/gain settings.

	Type	Hex Addr	Dec Addr
P03.11 Analog Input Gain (AI1)	◆R/W	030B	40780
P03.12 Analog Input Gain (AI2)	◆R/W	030C	40781
<i>Range/Units (Format: 16-bit signed)</i>	<i>Default</i>		
-500.0–500.0 %	100.0		

P03.03–P03.12 are used when the Frequency command source is the analog voltage or current signal. P03.50 must be set to zero for these parameters to be active.

See analog input examples at the end of this section for further explanation of bias/gain settings.

	Type	Hex Addr	Dec Addr
P03.15 Analog Input Filter Time (AI1)	◆R/W	030F	40784
P03.16 Analog Input Filter Time (AI2)	◆R/W	0310	40785
<i>Range/Units (Format: 16-bit signed)</i>	<i>Default</i>		
0.00–20.00 sec.	0.01		

Analog signals, such as those entering AI1 and AI2, are commonly affected by interference that affects the stability of the analog control. Use the Input Noise Filter to create a more stable system.

- When the time constant setting is too large, the control is stable but the control response is slow.
- When the time constant setting is too small, the control response is faster but the control may be unstable.
- For optimal setting, adjust the setting based on the control stability or the control response.

	Type	Hex Addr	Dec Addr
P03.18 Analog Input Addition Function	◆R/W	0312	40787
<i>Range/Units (Format: 16-bit binary)</i>	<i>Default</i>		
0: Disable (AI1, AI2)	0		
1: Enable			

Enables the analog input addition function when P03.18=1:

Example:

P03.00 = P03.01 = 1, Frequency command = AI1 + AI2

When P03.18=0 and the analog input selection settings (P03.00 and P03.01) are the same, AI1 has priority over AI2. For example, when P03.00 and P03.01 are both set to 1 (Frequency command), the drive ignores the setting value from AI2 but executes the Frequency command according to the setting value from AI1.

Frequency

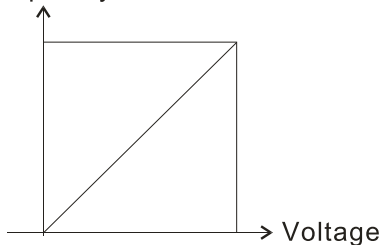

$$F \text{ command} = [(ay \pm \text{bias}) * \text{gain}] * \frac{F_{\text{max}} (P01.00)}{10V \text{ or } 16mA \text{ or } 20mA}$$

F command: the corresponding frequency for 10V or 20mA

ay: 0–10 V, 4–20 mA, 0–20 mA

bias: P03.03, P03.04

gain: P03.11, P03.12

	Type	Hex Addr	Dec Addr
P03.19 Signal Loss Selection for the Analog Input 4–20 mA	R/W	0313	40788
<i>Range/Units (Format: 16-bit binary)</i>	<i>Default</i>		
0: Disable	0		
1: Continue operation at the last frequency			
2: Decelerate to 0Hz			
3: Stop immediately and display “ACE”			

Determines the treatment when the 4–20 mA signal is lost (AI2 (P03.29 = 0)).

- When P03.29 ≠ 0, the voltage input to AI2 terminal is 0–10 V or 0–20 mA, and P03.19 is invalid.
- When the setting is 1 or 2, the keypad displays the warning code “ANL”. It keeps blinking until the AI2 signal is recovered.
- When the drive stops, the condition that causes the warning does not exist, so the warning automatically disappears.

P03.20 Multi-function Output (A01)	<i>Type</i>	<i>Hex Addr</i>	<i>Dec Addr</i>
	◆R/W	0314	40789
	<i>Default</i>		
<i>Range/Units (Format: 16-bit binary)</i>	0		

Summary of Function Settings

Setting	Function	Description				
0	Output frequency (Hz)	Maximum frequency P01.00 is processed as 100 %.				
1	Frequency command (Hz)	Maximum frequency P01.00 is processed as 100 %.				
2	Motor speed (Hz)	Maximum frequency P01.00 is processed as 100 %.				
3	Output current (rms)	(2.5 X drive rated current) is processed as 100 %.				
4	Output voltage	(2 X motor rated voltage) is processed as 100 %.				
5	DC bus voltage	120V/230V series: 450V = 100 % 460V series: 900V = 100 % 575V series: 1125V = 100 %				
6	Power factor	-1.000–1.000 = 100 %				
7	Power	(2 X drive rated power) is processed as 100 %.				
8	Output torque	Full-load torque = 100 %				
9	AI1	0–10 V = 0–100 %				
10	AI2	4–20 mA = 0–100 %				
12	Iq current command	(2.5 X drive rated current) is processed as 100 %.				
13	Iq feedback value	(2.5 X drive rated current) is processed as 100 %.				
14	Id current command	(2.5 X drive rated current) is processed as 100 %.				
15	Id feedback value	(2.5 X rated current) is processed as 100 %.				
16	Vq-axis voltage command	120V/230V series: 250V = 100 % 460V series: 500V = 100 % 575V series: 625V = 100 %				
17	Vd-axis voltage command	120V/230V series: 250V = 100 % 460V series: 500V = 100 % 575V series: 625V = 100 %				
18	Torque command	Motor rated torque = 100%				
19	PG2 (DI7) frequency command	Maximum operation frequency (Pr.01-00) is processed as 100 %.				
21	RS-485 analog output	For RS-485 (Modbus) control analog output <table border="1" style="margin-left: 20px;"> <thead> <tr> <th>Terminal</th> <th>Address</th> </tr> </thead> <tbody> <tr> <td>A01</td> <td>26A0H</td> </tr> </tbody> </table>	Terminal	Address	A01	26A0H
Terminal	Address					
A01	26A0H					
22	Communication card analog output	For communication analog output (GS20A-CM-ENETIP) <table border="1" style="margin-left: 20px;"> <thead> <tr> <th>Terminal</th> <th>Address</th> </tr> </thead> <tbody> <tr> <td>A01</td> <td>26A0H</td> </tr> </tbody> </table>	Terminal	Address	A01	26A0H
Terminal	Address					
A01	26A0H					
23	Constant voltage output	P03.32 controls the voltage output level. 0–100 % of P03.32 corresponds to 0–10 V for A01.				

P03.21 Analog Output Gain (A01)	<i>Type</i>	<i>Hex Addr</i>	<i>Dec Addr</i>
	◆R/W	0315	40790
	<i>Default</i>	100.0	
<i>Range/Units (Format: 16-bit unsigned)</i>	0.0–500.0 %		

P03.21 adjusts the voltage level output to the analog meter from the analog signal (P03.20) output terminal A01 of the drive. See P03.27 for equation.

P03.22 Analog Output in REV Direction (A01)

Range/Units (Format: 16-bit binary)

- 0: Absolute value in output voltage
- 1: Reverse output 0 V; forward output 0–10 V
- 2: Reverse output 5–0 V; forward output 5–10 V

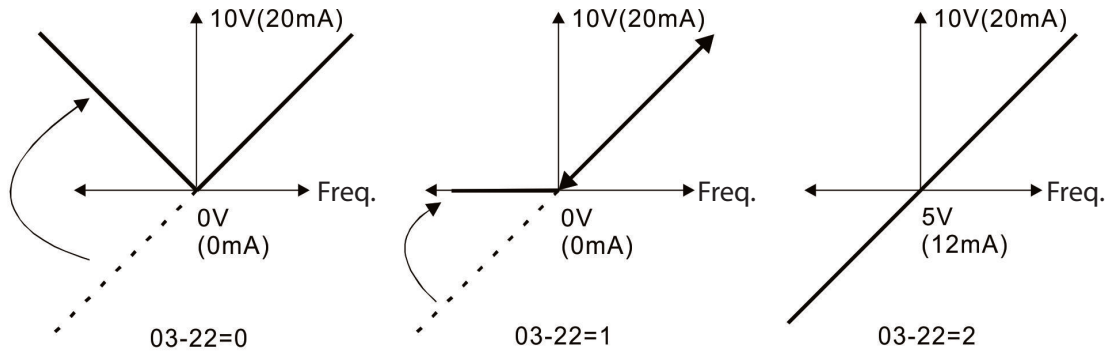

Type	Hex Addr	Dec Addr
◆R/W	0316	40791
<i>Default</i>		
	0	

P03.27 A01 Output Bias

Range/Units (Format: 16-bit signed)

-100.00–100.00 %

Type	Hex Addr	Dec Addr
◆R/W	031B	40796
<i>Default</i>		
	0.00	

This parameter sets the corresponding voltage of the analog output.

Example 1:

A01 0–10 V is set to the output frequency, the output equation is:

$$10 \text{ V} \times \left(\frac{\text{Output Frequency}}{\text{Pr.01-00}} \right) \times \text{Pr.03-21} + 10 \text{ V} \times \text{Pr.03-27}$$

Example 2:

A01 0–20 mA is set to the output frequency, the output equation is:

$$20 \text{ mA} \times \left(\frac{\text{Output Frequency}}{\text{Pr.01-00}} \right) \times \text{Pr.03-21} + 20 \text{ mA} \times \text{Pr.03-27}$$

Example 3:

A01 4–20 mA is set to the output frequency, the output equation is:

$$4 \text{ mA} + 16 \text{ mA} \times \left(\frac{\text{Output Frequency}}{\text{Pr.01-00}} \right) \times \text{Pr.03-21} + 16 \text{ mA} \times \text{Pr.03-27}$$

P03.28	A11 Terminal Input Selection	<i>Type</i>	<i>Hex Addr</i>	<i>Dec Addr</i>
		◆R/W	031C	40797
		<i>Default</i>	0	
<i>Range/Units (Format: 16-bit binary)</i>				
0: 0–10 V (P03.63–P03.68 is valid)				
3: -10–10 V (P03.69–P03.74 are valid)				

P03.29	A12 Terminal Input Selection	<i>Type</i>	<i>Hex Addr</i>	<i>Dec Addr</i>
		◆R/W	031D	40798
		<i>Default</i>	0	
<i>Range/Units (Format: 16-bit binary)</i>				
0: 4–20 mA				
1: 0–10 V				
2: 0–20 mA				

When you change the input mode, verify that the external terminal switch (A12) position is correct.

P03.30	PLC Analog Output Terminal Status	<i>Type</i>	<i>Hex Addr</i>	<i>Dec Addr</i>
		Read	031E	40799
		<i>Default</i>	0	
<i>Range/Units (Format: 16-bit unsigned)</i>				
Monitor the status of the PLC analog output terminals				
bit 0: A01				

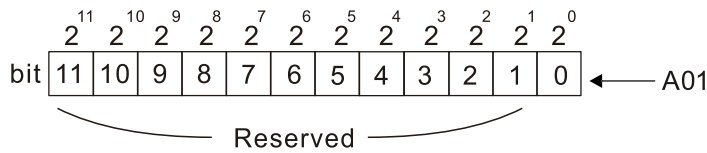

0=OFF
1=ON

NOTE			
$2^{11} = 2048$	$2^{10} = 1024$	$2^9 = 512$	$2^8 = 256$
$2^7 = 128$	$2^6 = 64$	$2^5 = 32$	$2^4 = 16$
$2^3 = 8$	$2^2 = 4$	$2^1 = 2$	$2^0 = 1$

Example:

When P03.30 displays 0001 (hex) (1 (decimal) and 1 (binary)), it means that A01 is used by PLC..

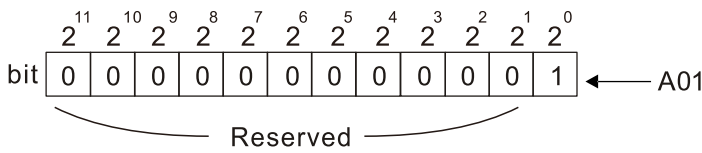

0=OFF
1=ON

Setting
= bit 0 x 2⁰
= 1 x 1
= 1

NOTE			
$2^{11} = 2048$	$2^{10} = 1024$	$2^9 = 512$	$2^8 = 256$
$2^7 = 128$	$2^6 = 64$	$2^5 = 32$	$2^4 = 16$
$2^3 = 8$	$2^2 = 4$	$2^1 = 2$	$2^0 = 1$

	Type	Hex Addr	Dec Addr
P03.31 A01 Output Selection	◆R/W	031F	40800
<i>Range/Units (Format: 16-bit binary)</i>	<i>Default</i>		
0: 0–10 V output	0		
1: 0–20 mA output			
2: 4–20 mA output			

	Type	Hex Addr	Dec Addr
P03.32 A01 DC Output Setting Level	◆R/W	0320	40801
<i>Range/Units (Format: 16-bit unsigned)</i>	<i>Default</i>		
0.00–100.00 %	0.0		

	Type	Hex Addr	Dec Addr
P03.35 A01 Output Filter Time	◆R/W	0323	40804
<i>Range/Units (Format: 16-bit unsigned)</i>	<i>Default</i>		
0.00–20.00 sec.	0		

	Type	Hex Addr	Dec Addr
P03.39 VR Input Selection (GS20 only)	◆R/W	0327	40808
<i>Range/Units (Format: 16-bit binary)</i>	<i>Default</i>		
0: Disable	1		
1: Frequency command			

VR is the abbreviation for Variable Resistor; it is the potentiometer of the integrated GS20 drive digital keypad. The VR can be selected for use in P00.20, P00.30, and P00.35 with setting 7: Digital Keypad VR/Potentiometer Dial (GS20 only). Applicable to GS20 models only - there is no VR on GS20X models.

	Type	Hex Addr	Dec Addr
P03.40 VR Input Bias (GS20 only)	◆R/W	0328	40809
<i>Range/Units (Format: 16-bit signed)</i>	<i>Default</i>		
-100–100 %	0.0		

	Type	Hex Addr	Dec Addr
P03.41 VR Positive / Negative Bias (GS20 only)	◆R/W	0329	40810
<i>Range/Units (Format: 16-bit binary)</i>	<i>Default</i>		
0: No bias	0		
1: Lower than or equal to bias			
2: Greater than or equal to bias			
3: The absolute value of the bias voltage while serving as the center			
4: Bias serves as the center			

	Type	Hex Addr	Dec Addr
P03.42 VR Gain (GS20 only)	◆R/W	032A	40811
<i>Range/Units (Format: 16-bit signed)</i>	<i>Default</i>		
-500.0–500.0 %	100.0		

	Type	Hex Addr	Dec Addr
P03.43 VR Filter Time (GS20 only)	R/W	032B	40812
<i>Range/Units (Format: 16-bit unsigned)</i>	<i>Default</i>		
0.00–2.00 sec.	0.01		

VR parameters are applicable to GS20 models only - there is no VR on GS20X models.

	Type	Hex Addr	Dec Addr
P03.44 Multi-function Output (DOx) by AI Level Source	◆R/W	032C	40813
<i>Range/Units (Format: 16-bit binary)</i>	<i>Default</i>		
0: AI1	0		
1: AI2			

	Type	Hex Addr	Dec Addr
P03.45 DOx - AI Upper Level	◆R/W	032D	40814
<i>Range/Units (Format: 16-bit signed)</i>	<i>Default</i>		
-100–100 %	50		

	Type	Hex Addr	Dec Addr
P03.46 DOx - AI Lower Level	◆R/W	032E	40815
<i>Range/Units (Format: 16-bit signed)</i>	<i>Default</i>		
-100–100 %	10		

Use parameters P03.44–P03.46 with multi-function output setting 67: (analog input level reached) on P02.13, P02.16, and P02.17. The digital output is active when the AI input level is higher than P03.45. The digital output is disabled when the AI input is lower than P03.46.

When setting levels, P03.45 DOx-AI upper level must be higher than P03.46 DOx-AI lower level.

	Type	Hex Addr	Dec Addr
P03.47 AI1%	Read	032F	40816
<i>Range/Units (Format: 16-bit signed)</i>	<i>Default</i>		
-100–100 %	0		

	Type	Hex Addr	Dec Addr
P03.48 AI2%	Read	0330	40817
<i>Range/Units (Format: 16-bit signed)</i>	<i>Default</i>		
-100–100 %	0		

Parameters P03.47 – P03.48 allow the user to monitor the actual input signal to the analog inputs. The configured voltage or current signal will display as -100 to 100%. These registers are read only.

	Type	Hex Addr	Dec Addr
P03.50 Analog Input Curve Selection	◆R/W	0332	40819
<i>Range/Units (Format: 16-bit binary)</i>	<i>Default</i>		
0: Normal curve	0		
1: Three-point curve of AI1			
2: Three-point curve of AI2			
3: Three-point curve of AI1 & AI2			

This parameter determines use of the gain/bias settings or the three point curve settings to adjust the frequency output command.

- P03.50=0: Normal Curve- This enables parameters P03.03, P03.04, P03.07, P03.10, P03.11, and P03.12 for AI1 and AI2. Proportional parameters are not used.
- P03.50=1:
Utilizes Parameters P03.63–P03.68. (if P03.28= 0) for AI1. Keeps Gain/Bias for AI2.
Utilizes Parameters P03.63–P03.74 (if P03.28=3) Keeps Gain/Bias for AI2.
- P03.50=2:
Utilizes parameters P03.57–P03.62 for AI2, Uses Gain/Bias for AI1.
- P03.50=3:
Utilizes parameters P03.57–P03.74 for AI1 and AI2. Gain/Bias is not used.

When 3-point curve mode is selected, P03.10 is not used. Forward/Reverse action is determined by the frequency polarity in the proportional parameters.

For a -10V to 10V signal in AI1, parameters P03.62 - P03.68 are used for the 0-10V signal and Parameters P03.69 to P03.74 are used for the -10-0V signal. This is effectively a 6 point curve.



NOTE: For -10V to 10V signal, parameters P03.62 - P03.68 are used to set the 0 to +10V portion of the signal.

	Type	Hex Addr	Dec Addr
P03.57 AI2 Lowest Point	◆R/W	0339	40826
<i>Range/Units (Format: 16-bit unsigned)</i>	<i>Default</i>		
P03.29 = 1, 0.00–10.00 V	4.00		
P03.29 ≠ 1, 0.00–20.00 mA			

When the input current falls below this parameter, the action defined in P03.19 will initiate.

	Type	Hex Addr	Dec Addr
P03.58 AI2 Proportional Lowest Point	◆R/W	033A	40827
<i>Range/Units (Format: 16-bit unsigned)</i>	<i>Default</i>		
-100.00–100.00 %	0.00		

	Type	Hex Addr	Dec Addr
P03.59 AI2 Mid-point	◆R/W	033B	40828
<i>Range/Units (Format: 16-bit unsigned)</i>	<i>Default</i>		
P03.29 = 1, 0.00–10.00 V	12.00		
P03.29 ≠ 1, 0.00–20.00 mA			

	Type	Hex Addr	Dec Addr
P03.60 AI2 Proportional Mid-point	◆R/W	033C	40829
<i>Range/Units (Format: 16-bit unsigned)</i>	<i>Default</i>		
-100.00–100.00 %	50.00		

	Type	Hex Addr	Dec Addr
P03.61 AI2 Highest Point	◆R/W	033D	40830
<i>Range/Units (Format: 16-bit unsigned)</i>	<i>Default</i>		
P03.29 = 1, 0.00–10.00 V	20.00		
P03.29 ≠ 1, 0.00–20.00 mA			

	Type	Hex Addr	Dec Addr
P03.62 AI2 Proportional Highest Point	◆R/W	033E	40831
<i>Range/Units (Format: 16-bit unsigned)</i>	<i>Default</i>		
-100.00–100.00 %	100.00		

When P03.29 = 1, the AI2 setting is 0–10 V and the unit is voltage (V).

When P03.29 ≠ 1, the AI2 setting is 0–20 mA or 4–20 mA and the unit is current (mA).

- When you set the analog input AI2 to the Frequency command, 100% corresponds to Fmax (P01.00 Maximum Operation Frequency).
- The requirement for the low, mid, and high point parameters (P03.57, P03.59 and P03.61) is P03.57 < P03.59 < P03.61. The values for three proportional points (P03.58, P03.60 and P03.62) have no limits. There is a linear calculation between two points.
- The output percentage becomes 0% when the AI2 input value is lower than the lowest point setting.

Example:

If P03.57 = 2mA; P03.58 = 10%, then the output becomes 0% when the AI2 input is ≤ 2mA.

Once the AI2 input goes above 2mA, the drive’s output frequency starts at 10%.

	Type	Hex Addr	Dec Addr
P03.63 AI1 Voltage Lowest Point	◆R/W	033F	40832
<i>Range/Units (Format: 16-bit unsigned)</i>	<i>Default</i>		
0.00–10.00 V	0.00		

	Type	Hex Addr	Dec Addr
P03.64 AI1 Proportional Lowest Point	◆R/W	0340	40833
<i>Range/Units (Format: 16-bit signed)</i>	<i>Default</i>		
-100.00–100.00 %	0.00		

	Type	Hex Addr	Dec Addr
P03.65 AI1 Voltage Mid-point	◆R/W	0341	40834
<i>Range/Units (Format: 16-bit unsigned)</i>	<i>Default</i>		
0.00–10.00 V	5.00		

	Type	Hex Addr	Dec Addr
P03.66 AI1 Proportional Mid-point	◆R/W	0342	40835
<i>Range/Units (Format: 16-bit signed)</i>	<i>Default</i>		
-100.00–100.00 %	50.00		

	Type	Hex Addr	Dec Addr
P03.67 AI1 Highest Point	◆R/W	0343	40836
<i>Range/Units (Format: 16-bit unsigned)</i>	<i>Default</i>		
0.00–10.00 V	10.00		

	Type	Hex Addr	Dec Addr
P03.68 AI1 Proportional Highest Point	◆R/W	0344	40837
<i>Range/Units (Format: 16-bit signed)</i>	<i>Default</i>		
-100.00–100.00 %	100.00		

When you set the positive voltage AI1 to the Frequency command, 100% corresponds to Fmax (P01.00 Maximum Operation Frequency) and the motor runs in the forward direction.

- The requirement for the low, mid, and high point parameters (P03.63, P03.65, and P03.67) is $P03.63 < P03.65 < P03.67$. The values for three proportional points (P03.64, P03.66 and P03.68) have no limits. There is a linear calculation between two points.
- The output percentage becomes 0 % when the positive voltage AI1 input value is lower than the lowest point setting.

Example:

If P03.63 = 1V; P03.64 = 10%, then the output becomes 0% when the AI1 input is $\leq 1V$.

Once the AI1 input increases above 1V, the drive output frequency will start at 10%.

	Type	Hex Addr	Dec Addr
P03.69 Negative AI1 Voltage Highest Point	◆R/W	0345	40838
<i>Range/Units (Format: 16-bit signed)</i>	<i>Default</i>		
-10.00–0.00 V (valid when P03.28 set as -10–10 V)	0.00		

	Type	Hex Addr	Dec Addr
P03.70 Negative AI1 Proportional Highest Point	◆R/W	0346	40839
<i>Range/Units (Format: 16-bit signed)</i>	<i>Default</i>		
-100.00–100.00 % (valid when P03.28 set as -10–10 V)	0.00		

	Type	Hex Addr	Dec Addr
P03.71 Negative AI1 Voltage Mid-point	◆R/W	0347	40840
<i>Range/Units (Format: 16-bit signed)</i>	<i>Default</i>		
-10.00–0.00 V (valid when P03.28 set as -10–10 V)	-5.00		

P03.72	Negative AI1 Proportional Mid-point	<i>Type</i>	<i>Hex Addr</i>	<i>Dec Addr</i>
	<i>Range/Units (Format: 16-bit signed)</i>	◆R/W	0348	40841
	-100.00–100.00 % (valid when P03.28 set as -10–10 V)	<i>Default</i>		-50.00
P03.73	Negative AI1 Lowest Point	<i>Type</i>	<i>Hex Addr</i>	<i>Dec Addr</i>
	<i>Range/Units (Format: 16-bit signed)</i>	◆R/W	0349	40842
	-10.00–0.00 V (valid when P03.28 set as -10–10 V)	<i>Default</i>		-10.00
P03.74	Negative AI1 Proportional Lowest Point	<i>Type</i>	<i>Hex Addr</i>	<i>Dec Addr</i>
	<i>Range/Units (Format: 16-bit signed)</i>	◆R/W	034A	40843
	-100.00–100.00 % (valid when P03.28 set as -10–10 V)	<i>Default</i>		-100.00

When you set the negative voltage AI1 to the Frequency command, -100% corresponds to Fmax (P01.00 Maximum Operation Frequency) and the motor runs in the reverse direction.

- The requirement for the low, mid, and high point parameters (P03.69, P03.71, and P03.73) is $P03.69 < P03.71 < P03.73$, the values for three proportional points (P03.70, P03.72, and P03.74) have no limits. There is a linear calculation between two points.
- The output percentage becomes 0% when the negative voltage AI1 input value is lower than the lowest point setting.

Example:

If P03.69 = -1V; P03.70 = 10%, then the output becomes 0% when the AI1 input is $\geq -1V$.

If the AI1 input swings between -1V and -1.1 V, drive's output frequency oscillates between 0% and 10%.



NOTE: For -10V to 10V signal, parameters P03.69 - P03.74 are used to set the 0 to -10V signal.

ANALOG INPUT PARAMETER EXAMPLES

Refer to the following equations and examples for changing the ratio of the analog input signal relative to the output frequency of the drive.

There are 2 methods of changing the ratio: Three point curve or Bias/Gain. Either method can be used and is largely a matter of user preference.

THREE POINT CURVE (P03.50 ≠ 0):

The Three Point Curve parameters are used to set the low, mid, and high input signals corresponding to a low, mid, and high proportional output value. This method eliminates the need for using any mathematic equations by the user. A curve slope will be calculated automatically between the low and mid point values, and the mid and high point values. See “Analog Input Parameter Example 11: Forward and Reverse Operation with -10V to +10V Input” on page 4–138 for Three point curve using a -10 to 10V input signal.

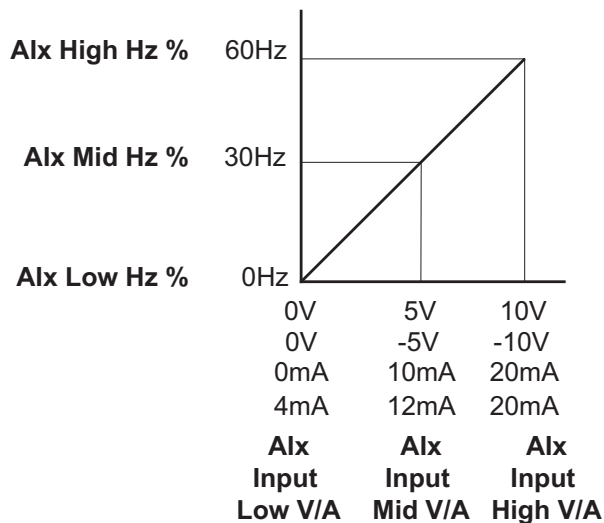

Analog Input	A11	A12
Polarity	0–10 V	Positive (+)
Curve Selection	P03.50 = 1 or 3	P03.50 = 2 or 3
Low V/A	P03.63	P03.57
Low Hz Percent	P03.64	P03.58
Mid V/A	P03.65	P03.59
Mid Hz Percent	P03.66	P03.60
High V/A	P03.67	P03.61
High Hz Percent	P03.68	P03.62

BIAS/GAIN (P03.50 = 0: NORMAL CURVE, DEFAULT):

The Normal Curve setting utilizes 4 different parameters to modify the output frequency of the drive. The bias/gain parameters work in accordance with the Pos/Neg bias mode and reverse setting parameter. Use diagrams 1 - 32 to understand the frequency outputs that will result from these parameter settings.

Analog Input	A11	A12
Bias Parameter	P03.03	P03.04
Pos/Neg Bias Parameter	P03.07	P03.08
Gain Parameter	P03.11	P03.12
Reverse Setting Parameter	P03.10	
Curve Parameter	P03.50	
Drive Max Output Freq	P01.00	

- Frequency output at default bias/gain settings
- Manipulated frequency output based on listed parameter values

Bias and Gain Example 1:

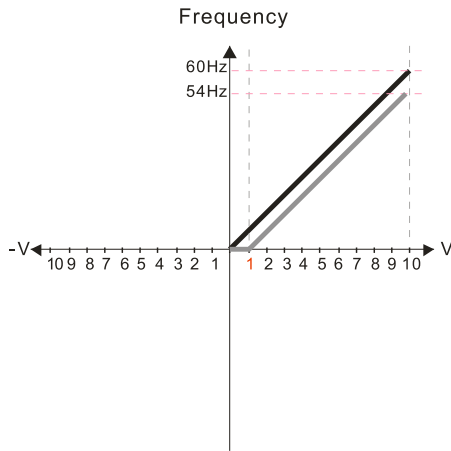

P03.03=10%
P03.07–P03.08 (Positive/Negative Bias Mode)

- 0: No bias
- 1: Lower than or equal bias
- 2: Greater than or equal to bias
- 3: The absolute value of the bias voltage while serving as the center
- 4: Bias serves as the center

P03.10 (Analog Frequency Command for Reverse Run)

- 0: Negative frequency is not valid. Forward and reverse run is controlled by digital keyboard or external terminals.
- 1: Negative frequency is valid. Positive frequency = forward run; negative frequency = reverse run. Direction can not be switched by digital keypad or external terminal control.

P03.11 Analog input Gain (A11) = 100%

Bias and Gain Example 2:

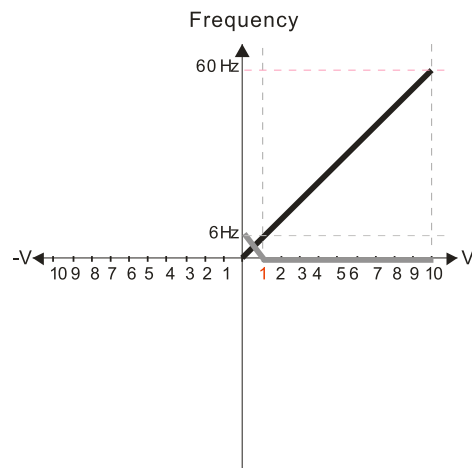

P03.03=10%
P03.07–P03.08 (Positive/Negative Bias Mode)

- 0: No bias
- 1: Lower than or equal bias
- 2: Greater than or equal to bias
- 3: The absolute value of the bias voltage while serving as the center
- 4: Bias serves as the center

P03.10 (Analog Frequency Command for Reverse Run)

- 0: Negative frequency is not valid. Forward and reverse run is controlled by digital keyboard or external terminals.
- 1: Negative frequency is valid. Positive frequency = forward run; negative frequency = reverse run. Direction can not be switched by digital keypad or external terminal control.

P03.11 Analog input Gain (A11) = 100%

Bias and Gain Example 3:

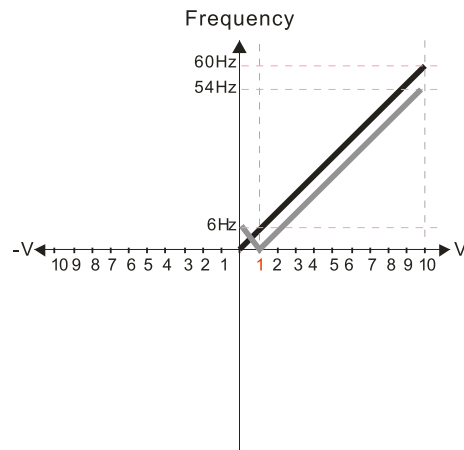

P03.03=10%
P03.07–P03.08 (Positive/Negative Bias Mode)

- 0: No bias
- 1: Lower than or equal bias
- 2: Greater than or equal to bias
- 3: The absolute value of the bias voltage while serving as the center
- 4: Bias serves as the center

P03.10 (Analog Frequency Command for Reverse Run)

- 0: Negative frequency is not valid. Forward and reverse run is controlled by digital keyboard or external terminals.
- 1: Negative frequency is valid. Positive frequency = forward run; negative frequency = reverse run. Direction can not be switched by digital keypad or external terminal control.

P03.11 Analog input Gain (A11) = 100%

- Frequency output at default bias/gain settings
- Manipulated frequency output based on listed parameter values

Bias and Gain Example 4:

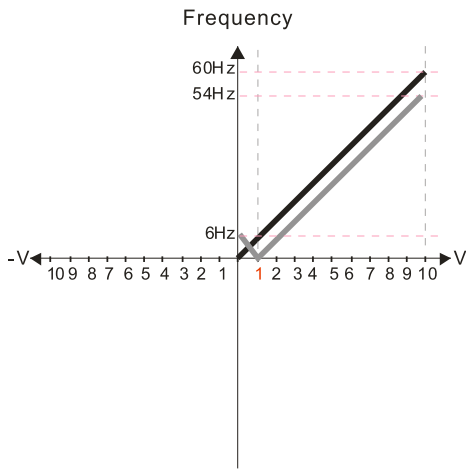

P03.03=10%
P03.07–P03.08 (Positive/Negative Bias Mode)

- 0: No bias
- 1: Lower than or equal bias
- 2: Greater than or equal to bias
- 3: The absolute value of the bias voltage while serving as the center
- 4: Bias serves as the center

P03.10 (Analog Frequency Command for Reverse Run)

- 0: Negative frequency is not valid. Forward and reverse run is controlled by digital keyboard or external terminals.
- 1: Negative frequency is valid.

Positive frequency = forward run; negative frequency = reverse run. Direction can not be switched by digital keypad or external terminal control.

P03.11 Analog input Gain (AI1) = 100%

Bias and Gain Example 5:

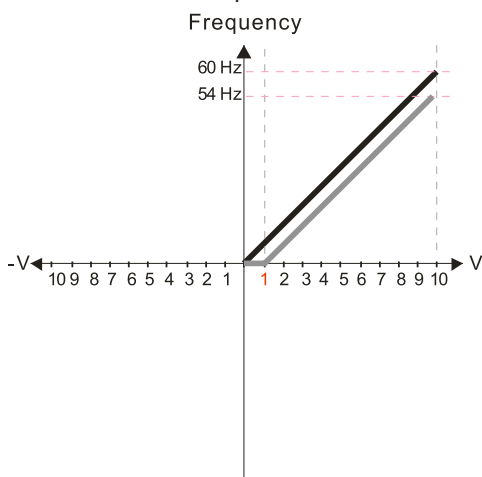

P03.03=10%
P03.07–P03.08 (Positive/Negative Bias Mode)

- 0: No bias
- 1: Lower than or equal bias
- 2: Greater than or equal to bias
- 3: The absolute value of the bias voltage while serving as the center
- 4: Bias serves as the center

P03.10 (Analog Frequency Command for Reverse Run)

- 0: Negative frequency is not valid. Forward and reverse run is controlled by digital keyboard or external terminals.
- 1: Negative frequency is valid.

Positive frequency = forward run; negative frequency = reverse run. Direction can not be switched by digital keypad or external terminal control.

P03.11 Analog input Gain (AI1) = 100%

Bias and Gain Example 6:

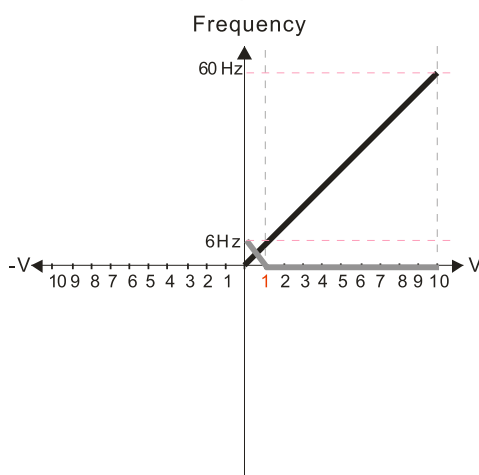

P03.03=10%
P03.07–P03.08 (Positive/Negative Bias Mode)

- 0: No bias
- 1: Lower than or equal bias
- 2: Greater than or equal to bias
- 3: The absolute value of the bias voltage while serving as the center
- 4: Bias serves as the center

P03.10 (Analog Frequency Command for Reverse Run)

- 0: Negative frequency is not valid. Forward and reverse run is controlled by digital keyboard or external terminals.
- 1: Negative frequency is valid.

Positive frequency = forward run; negative frequency = reverse run. Direction can not be switched by digital keypad or external terminal control.

P03.11 Analog input Gain (AI1) = 100%

- Frequency output at default bias/gain settings
- Manipulated frequency output based on listed parameter values

Bias and Gain Example 7:

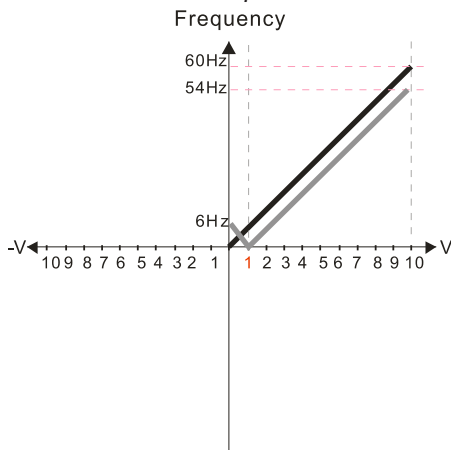

P03.03=10%
P03.07–P03.08 (Positive/Negative Bias Mode)

- 0: No bias
- 1: Lower than or equal bias
- 2: Greater than or equal to bias
- 3: The absolute value of the bias voltage while serving as the center
- 4: Bias serves as the center

P03.10 (Analog Frequency Command for Reverse Run)

- 0: Negative frequency is not valid. Forward and reverse run is controlled by digital keyboard or external terminals.
- 1: Negative frequency is valid. Positive frequency = forward run; negative frequency = reverse run. Direction can not be switched by digital keypad or external terminal control.

P03.11 Analog input Gain (A11) = 100%

Bias and Gain Example 8:

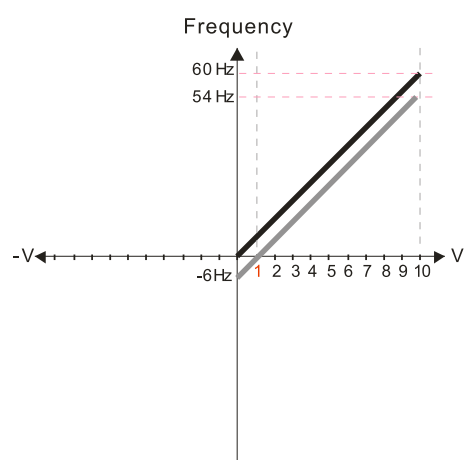

P03.03=10%
P03.07–P03.08 (Positive/Negative Bias Mode)

- 0: No bias
- 1: Lower than or equal bias
- 2: Greater than or equal to bias
- 3: The absolute value of the bias voltage while serving as the center
- 4: Bias serves as the center

P03.10 (Analog Frequency Command for Reverse Run)

- 0: Negative frequency is not valid. Forward and reverse run is controlled by digital keyboard or external terminals.
- 1: Negative frequency is valid. Positive frequency = forward run; negative frequency = reverse run. Direction can not be switched by digital keypad or external terminal control.

P03.11 Analog input Gain (A11) = 100%

Bias and Gain Example 9:

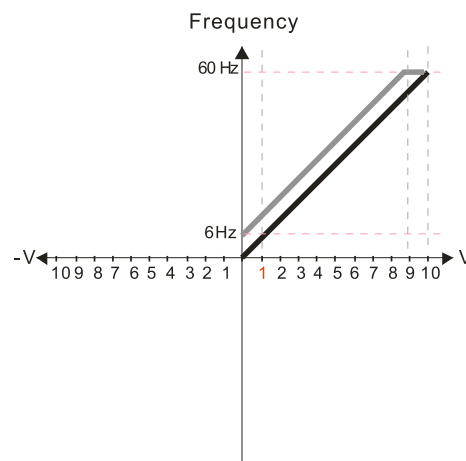

P03.03=-10%
P03.07–P03.08 (Positive/Negative Bias Mode)

- 0: No bias
- 1: Lower than or equal bias
- 2: Greater than or equal to bias
- 3: The absolute value of the bias voltage while serving as the center
- 4: Bias serves as the center

P03.10 (Analog Frequency Command for Reverse Run)

- 0: Negative frequency is not valid. Forward and reverse run is controlled by digital keyboard or external terminals.
- 1: Negative frequency is valid. Positive frequency = forward run; negative frequency = reverse run. Direction can not be switched by digital keypad or external terminal control.

P03.11 Analog input Gain (A11) = 100%

- Frequency output at default bias/gain settings
- Manipulated frequency output based on listed parameter values

Bias and Gain Example 10:

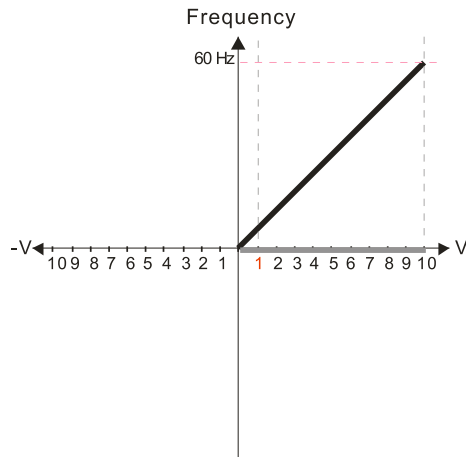

P03.03=-10%
P03.07-P03.08 (Positive/Negative Bias Mode)

- 0: No bias
- 1: Lower than or equal bias
- 2: Greater than or equal to bias
- 3: The absolute value of the bias voltage while serving as the center
- 4: Bias serves as the center

P03.10 (Analog Frequency Command for Reverse Run)

- 0: Negative frequency is not valid. Forward and reverse run is controlled by digital keyboard or external terminals.
- 1: Negative frequency is valid. Positive frequency = forward run; negative frequency = reverse run. Direction can not be switched by digital keypad or external terminal control.

P03.11 Analog input Gain (AI1) = 100%

Bias and Gain Example 11:

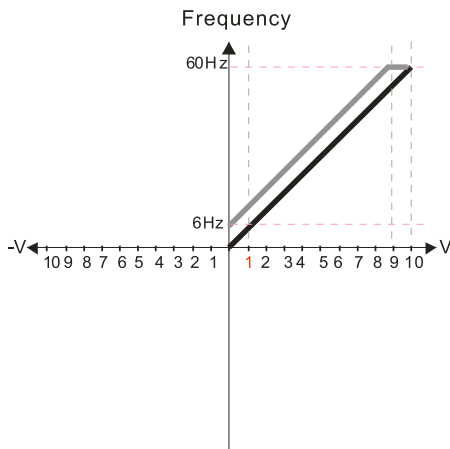

P03.03=-10%
P03.07-P03.08 (Positive/Negative Bias Mode)

- 0: No bias
- 1: Lower than or equal bias
- 2: Greater than or equal to bias
- 3: The absolute value of the bias voltage while serving as the center
- 4: Bias serves as the center

P03.10 (Analog Frequency Command for Reverse Run)

- 0: Negative frequency is not valid. Forward and reverse run is controlled by digital keyboard or external terminals.
- 1: Negative frequency is valid. Positive frequency = forward run; negative frequency = reverse run. Direction can not be switched by digital keypad or external terminal control.

P03.11 Analog input Gain (AI1) = 100%

Bias and Gain Example 12:

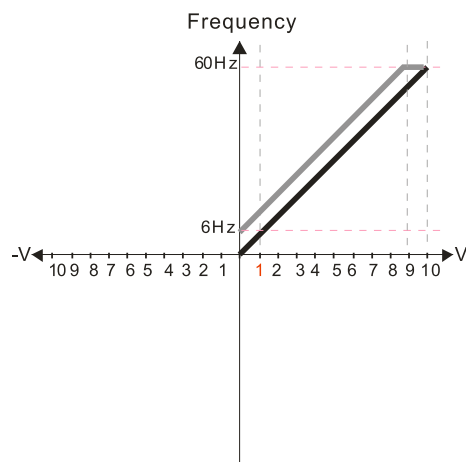

P03.03=-10%
P03.07-P03.08 (Positive/Negative Bias Mode)

- 0: No bias
- 1: Lower than or equal bias
- 2: Greater than or equal to bias
- 3: The absolute value of the bias voltage while serving as the center
- 4: Bias serves as the center

P03.10 (Analog Frequency Command for Reverse Run)

- 0: Negative frequency is not valid. Forward and reverse run is controlled by digital keyboard or external terminals.
- 1: Negative frequency is valid. Positive frequency = forward run; negative frequency = reverse run. Direction can not be switched by digital keypad or external terminal control.

P03.11 Analog input Gain (AI1) = 100%

- Frequency output at default bias/gain settings
- Manipulated frequency output based on listed parameter values

Bias and Gain Example 13:

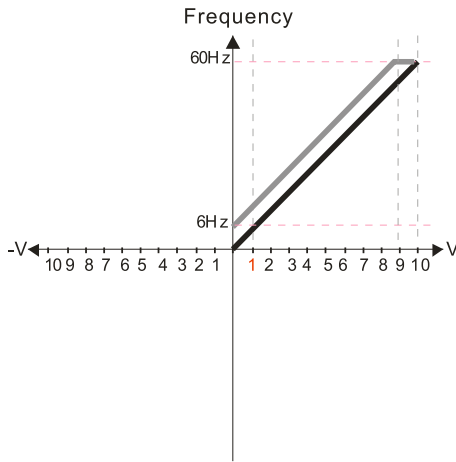

P03.03=-10%
P03.07-P03.08 (Positive/Negative Bias Mode)

- 0: No bias
- 1: Lower than or equal bias
- 2: Greater than or equal to bias
- 3: The absolute value of the bias voltage while serving as the center
- 4: Bias serves as the center

P03.10 (Analog Frequency Command for Reverse Run)
0: Negative frequency is not valid. Forward and reverse run is controlled by digital keyboard or external terminals.
1: Negative frequency is valid. Positive frequency = forward run; negative frequency = reverse run. Direction can not be switched by digital keypad or external terminal control.

P03.11 Analog input Gain (A11) = 100%

Bias and Gain Example 14:

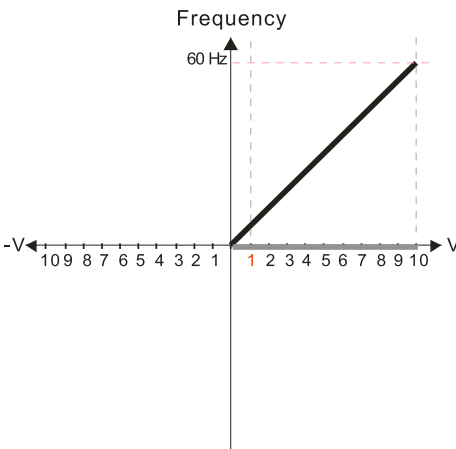

P03.03=-10%
P03.07-P03.08 (Positive/Negative Bias Mode)

- 0: No bias
- 1: Lower than or equal bias
- 2: Greater than or equal to bias
- 3: The absolute value of the bias voltage while serving as the center
- 4: Bias serves as the center

P03.10 (Analog Frequency Command for Reverse Run)
0: Negative frequency is not valid. Forward and reverse run is controlled by digital keyboard or external terminals.
1: Negative frequency is valid. Positive frequency = forward run; negative frequency = reverse run. Direction can not be switched by digital keypad or external terminal control.

P03.11 Analog input Gain (A11) = 100%

Bias and Gain Example 15:

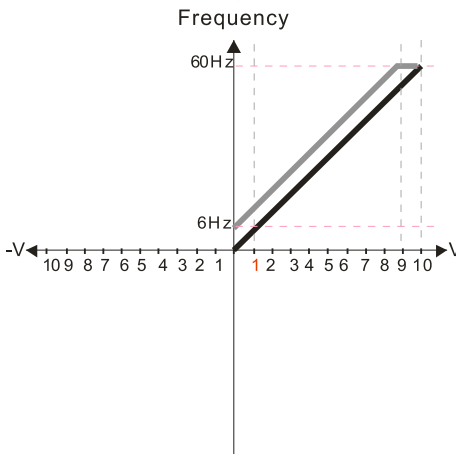

P03.03=-10%
P03.07-P03.08 (Positive/Negative Bias Mode)

- 0: No bias
- 1: Lower than or equal bias
- 2: Greater than or equal to bias
- 3: The absolute value of the bias voltage while serving as the center
- 4: Bias serves as the center

P03.10 (Analog Frequency Command for Reverse Run)
0: Negative frequency is not valid. Forward and reverse run is controlled by digital keyboard or external terminals.
1: Negative frequency is valid. Positive frequency = forward run; negative frequency = reverse run. Direction can not be switched by digital keypad or external terminal control.

P03.11 Analog input Gain (A11) = 100%

- Frequency output at default bias/gain settings
- Manipulated frequency output based on listed parameter values

Bias and Gain Example 16:

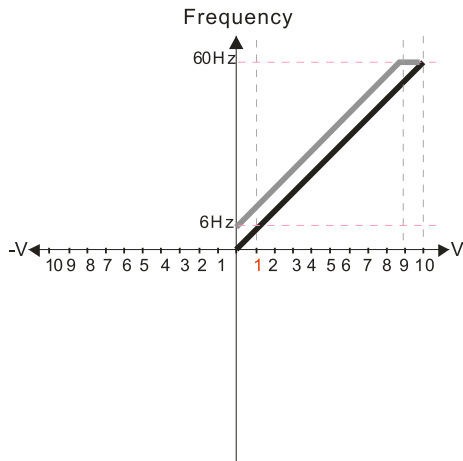

P03.03=-10%
P03.07-P03.08 (Positive/Negative Bias Mode)

- 0: No bias
- 1: Lower than or equal bias
- 2: Greater than or equal to bias
- 3: The absolute value of the bias voltage while serving as the center
- 4: Bias serves as the center

P03.10 (Analog Frequency Command for Reverse Run)

- 0: Negative frequency is not valid. Forward and reverse run is controlled by digital keyboard or external terminals.
- 1: Negative frequency is valid. Positive frequency = forward run; negative frequency = reverse run. Direction can not be switched by digital keypad or external terminal control.

P03.11 Analog input Gain (A11) = 100%

Bias and Gain Example 17:

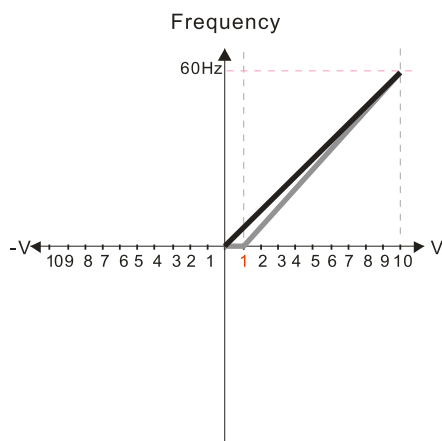

P03.03=10%
P03.07-P03.08 (Positive/Negative Bias Mode)

- 0: No bias
- 1: Lower than or equal bias
- 2: Greater than or equal to bias
- 3: The absolute value of the bias voltage while serving as the center
- 4: Bias serves as the center

P03.10 (Analog Frequency Command for Reverse Run)

- 0: Negative frequency is not valid. Forward and reverse run is controlled by digital keyboard or external terminals.
- 1: Negative frequency is valid. Positive frequency = forward run; negative frequency = reverse run. Direction can not be switched by digital keypad or external terminal control.

P03.11 Analog input Gain (A11) = 111.1%
 $10/9 = 111.1\%$

Bias and Gain Example 18:

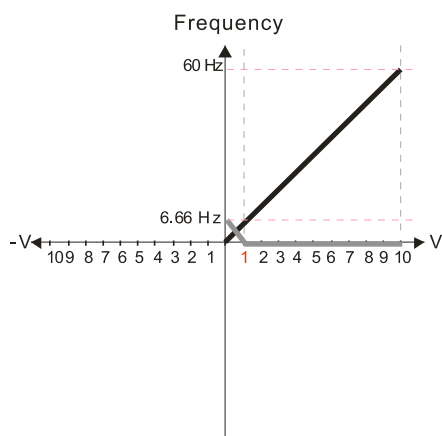

P03.03=10%
P03.07-P03.08 (Positive/Negative Bias Mode)

- 0: No bias
- 1: Lower than or equal bias
- 2: Greater than or equal to bias
- 3: The absolute value of the bias voltage while serving as the center
- 4: Bias serves as the center

P03.10 (Analog Frequency Command for Reverse Run)

- 0: Negative frequency is not valid. Forward and reverse run is controlled by digital keyboard or external terminals.
- 1: Negative frequency is valid. Positive frequency = forward run; negative frequency = reverse run. Direction can not be switched by digital keypad or external terminal control.

P03.11 Analog input Gain (A11) = 111.1%
 $10/9 = 111.1\%$

- Frequency output at default bias/gain settings
- Manipulated frequency output based on listed parameter values

Bias and Gain Example 19:

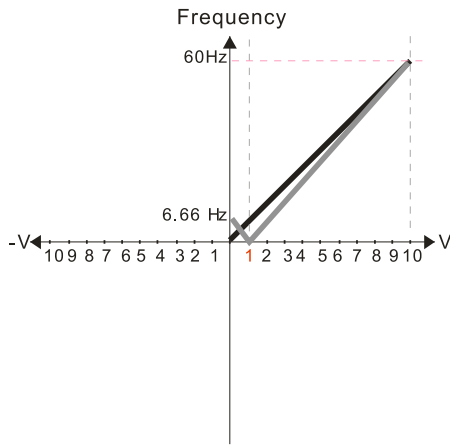

P03.03=10%
P03.07–P03.08 (Positive/Negative Bias Mode)

- 0: No bias
- 1: Lower than or equal bias**
- 2: Greater than or equal to bias
- 3: The absolute value of the bias voltage while serving as the center
- 4: Bias serves as the center

P03.10 (Analog Frequency Command for Reverse Run)

- 0: Negative frequency is not valid. Forward and reverse run is controlled by digital keyboard or external terminals.
- 1: Negative frequency is valid. Positive frequency = forward run; negative frequency = reverse run. Direction can not be switched by digital keypad or external terminal control.**

P03.11 Analog input Gain (A11) = 111.1%
10/9 = 111.1%

Bias and Gain Example 20:

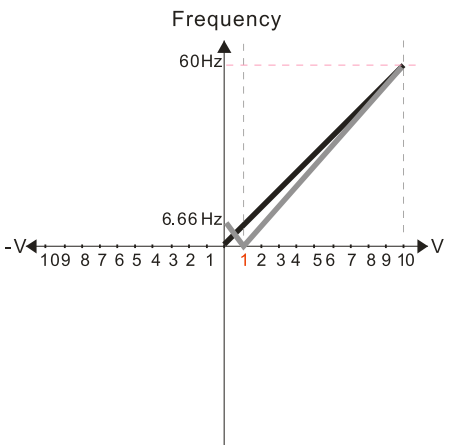

P03.03=10%
P03.07–P03.08 (Positive/Negative Bias Mode)

- 0: No bias
- 1: Lower than or equal bias
- 2: Greater than or equal to bias
- 3: The absolute value of the bias voltage while serving as the center
- 4: Bias serves as the center**

P03.10 (Analog Frequency Command for Reverse Run)

- 0: Negative frequency is not valid. Forward and reverse run is controlled by digital keyboard or external terminals.
- 1: Negative frequency is valid. Positive frequency = forward run; negative frequency = reverse run. Direction can not be switched by digital keypad or external terminal control.**

P03.11 Analog input Gain (A11) = 111.1%
10/9 = 111.1%

Bias and Gain Example 21:

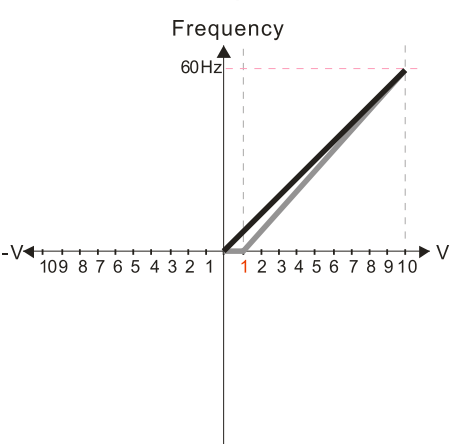

P03.03=10%
P03.07–P03.08 (Positive/Negative Bias Mode)

- 0: No bias
- 1: Lower than or equal bias**
- 2: Greater than or equal to bias
- 3: The absolute value of the bias voltage while serving as the center
- 4: Bias serves as the center

P03.10 (Analog Frequency Command for Reverse Run)

- 0: Negative frequency is not valid. Forward and reverse run is controlled by digital keyboard or external terminals.
- 1: Negative frequency is valid. Positive frequency = forward run; negative frequency = reverse run. Direction can not be switched by digital keypad or external terminal control.**

P03.11 Analog input Gain (A11) = 111.1%
10/9 = 111.1%

- Frequency output at default bias/gain settings
- Manipulated frequency output based on listed parameter values

Bias and Gain Example 22:

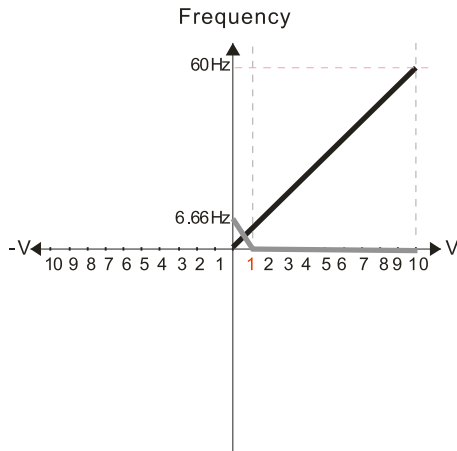

P03.03=10%
P03.07–P03.08 (Positive/Negative Bias Mode)

- 0: No bias
- 1: Lower than or equal bias
- 2: Greater than or equal to bias
- 3: The absolute value of the bias voltage while serving as the center
- 4: Bias serves as the center

P03.10 (Analog Frequency Command for Reverse Run)

- 0: Negative frequency is not valid. Forward and reverse run is controlled by digital keyboard or external terminals.
- 1: Negative frequency is valid. Positive frequency = forward run; negative frequency = reverse run. Direction can not be switched by digital keypad or external terminal control.

P03.11 Analog input Gain (A11) = 111.1%
10/9 = 111.1%

Bias and Gain Example 23:

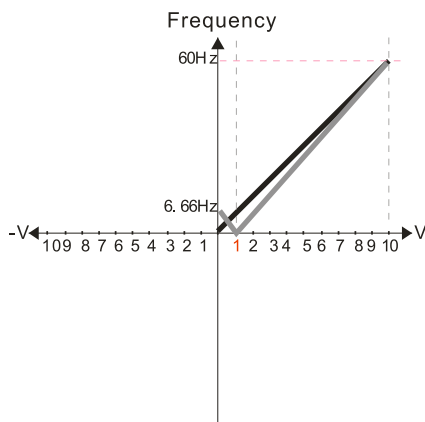

P03.03=10%
P03.07–P03.08 (Positive/Negative Bias Mode)

- 0: No bias
- 1: Lower than or equal bias
- 2: Greater than or equal to bias
- 3: The absolute value of the bias voltage while serving as the center
- 4: Bias serves as the center

P03.10 (Analog Frequency Command for Reverse Run)

- 0: Negative frequency is not valid. Forward and reverse run is controlled by digital keyboard or external terminals.
- 1: Negative frequency is valid. Positive frequency = forward run; negative frequency = reverse run. Direction can not be switched by digital keypad or external terminal control.

P03.11 Analog input Gain (A11) = 111.1%
10/9 = 111.1%

Bias and Gain Example 24:

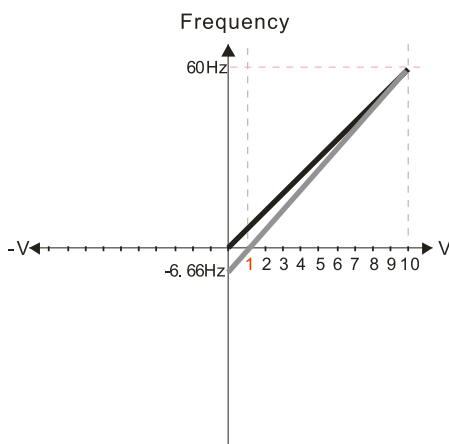

P03.03=10%
P03.07–P03.08 (Positive/Negative Bias Mode)

- 0: No bias
- 1: Lower than or equal bias
- 2: Greater than or equal to bias
- 3: The absolute value of the bias voltage while serving as the center
- 4: Bias serves as the center

P03.10 (Analog Frequency Command for Reverse Run)

- 0: Negative frequency is not valid. Forward and reverse run is controlled by digital keyboard or external terminals.
- 1: Negative frequency is valid. Positive frequency = forward run; negative frequency = reverse run. Direction can not be switched by digital keypad or external terminal control.

P03.11 Analog input Gain (A11) = 111.1%
10/9 = 111.1%

- Frequency output at default bias/gain settings
- Manipulated frequency output based on listed parameter values

Bias and Gain Example 25:

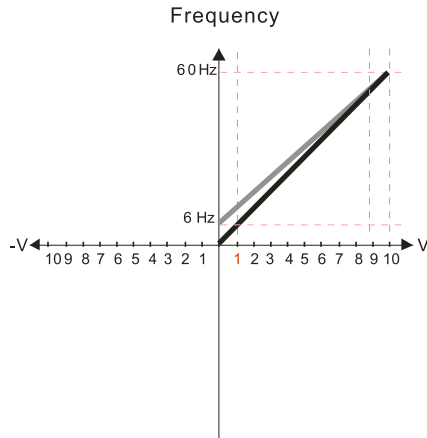

P03.07–P03.08 (Positive/Negative Bias Mode)

- 0: No bias
- 1: Lower than or equal bias
- 2: Greater than or equal to bias
- 3: The absolute value of the bias voltage while serving as the center
- 4: Bias serves as the center

P03.10 (Analog Frequency Command for Reverse Run)

- 0: Negative frequency is not valid. Forward and reverse run is controlled by digital keyboard or external terminals.
- 1: Negative frequency is valid. Positive frequency = forward run; negative frequency = reverse run. Direction can not be switched by digital keypad or external terminal control.

Calculate the bias:

$$\frac{60-6\text{Hz}}{10\text{V}} = \frac{6-0\text{Hz}}{(0-X)\text{V}} \quad X\text{V} = \frac{100}{-9} = -11.1\text{V} \quad \therefore 03-03 = \frac{-1.1}{10} \times 100\% = -11.1\%$$

Calculate the gain:

$$P03.11 = \frac{10\text{V}}{11.1\text{V}} \times 100\% = 90.0\%$$

Bias and Gain Example 26:

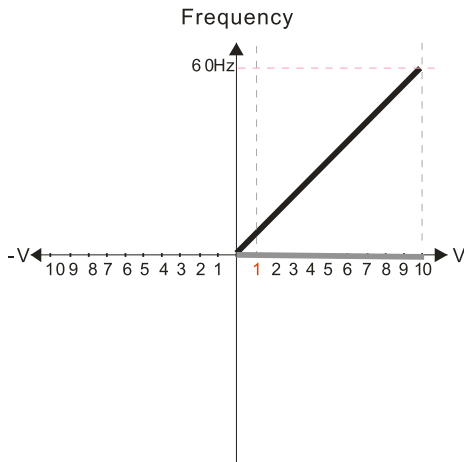

P03.07–P03.08 (Positive/Negative Bias Mode)

- 0: No bias
- 1: Lower than or equal bias
- 2: Greater than or equal to bias
- 3: The absolute value of the bias voltage while serving as the center
- 4: Bias serves as the center

P03.10 (Analog Frequency Command for Reverse Run)

- 0: Negative frequency is not valid. Forward and reverse run is controlled by digital keyboard or external terminals.
- 1: Negative frequency is valid. Positive frequency = forward run; negative frequency = reverse run. Direction can not be switched by digital keypad or external terminal control.

Bias and Gain Example 27:

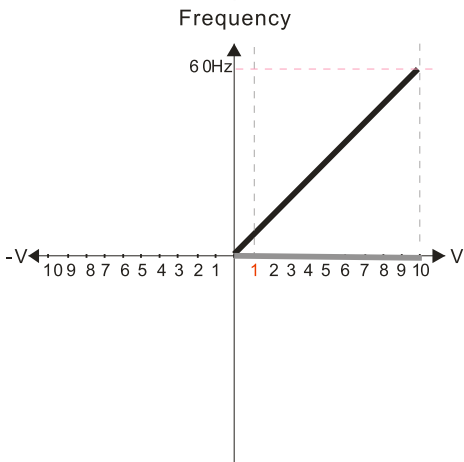

P03.07–P03.08 (Positive/Negative Bias Mode)

- 0: No bias
- 1: Lower than or equal bias
- 2: Greater than or equal to bias
- 3: The absolute value of the bias voltage while serving as the center
- 4: Bias serves as the center

P03.10 (Analog Frequency Command for Reverse Run)

- 0: Negative frequency is not valid. Forward and reverse run is controlled by digital keyboard or external terminals.
- 1: Negative frequency is valid. Positive frequency = forward run; negative frequency = reverse run. Direction can not be switched by digital keypad or external terminal control.

- Frequency output at default bias/gain settings
- Manipulated frequency output based on listed parameter values

Bias and Gain Example 28:

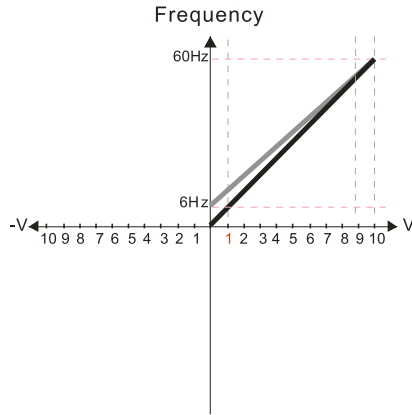

P03.07–P03.08 (Positive/Negative Bias Mode)

- 0: No bias
- 1: Lower than or equal bias
- 2: Greater than or equal to bias
- 3: The absolute value of the bias voltage while serving as the center
- 4: Bias serves as the center

P03.10 (Analog Frequency Command for Reverse Run)

- 0: Negative frequency is not valid. Forward and reverse run is controlled by digital keyboard or external terminals.
- 1: Negative frequency is valid. Positive frequency = forward run; negative frequency = reverse run. Direction can not be switched by digital keypad or external terminal control.

Calculate the bias:

$$\frac{60-6\text{Hz}}{10\text{V}} = \frac{6-0\text{Hz}}{(0-X\text{V})} \quad X\text{V} = \frac{100}{-9} = -1.11\text{V} \quad \therefore 03-03 = \frac{-1.11}{10} \times 100\% = -11.1\%$$

Calculate the gain:

$$P03.11 = \frac{10\text{V}}{11.1\text{V}} \times 100\% = 90.0\%$$

Bias and Gain Example 29:

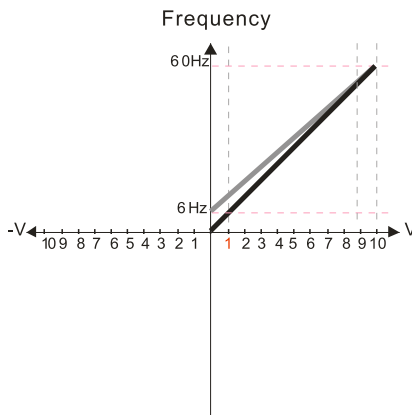

P03.07–P03.08 (Positive/Negative Bias Mode)

- 0: No bias
- 1: Lower than or equal bias
- 2: Greater than or equal to bias
- 3: The absolute value of the bias voltage while serving as the center
- 4: Bias serves as the center

P03.10 (Analog Frequency Command for Reverse Run)

- 0: Negative frequency is not valid. Forward and reverse run is controlled by digital keyboard or external terminals.
- 1: Negative frequency is valid. Positive frequency = forward run; negative frequency = reverse run. Direction can not be switched by digital keypad or external terminal control.

Calculate the bias:

$$\frac{60-6\text{Hz}}{10\text{V}} = \frac{6-0\text{Hz}}{(0-X\text{V})} \quad X\text{V} = \frac{100}{-9} = -1.11\text{V} \quad \therefore 03-03 = \frac{-1.11}{10} \times 100\% = -11.1\%$$

Calculate the gain:

$$P03.11 = \frac{10\text{V}}{11.1\text{V}} \times 100\% = 90.0\%$$

- Frequency output at default bias/gain settings
- Manipulated frequency output based on listed parameter values

Bias and Gain Example 30:

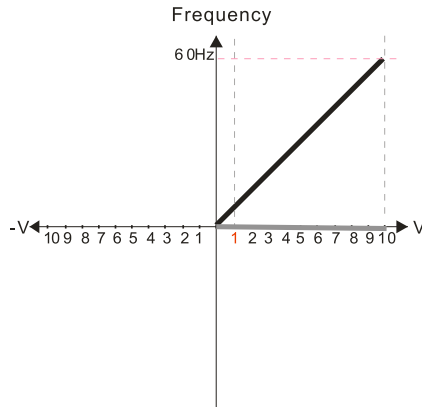

P03.07–P03.08 (Positive/Negative Bias Mode)

- 0: No bias
- 1: Lower than or equal bias
- 2: Greater than or equal to bias
- 3: The absolute value of the bias voltage while serving as the center
- 4: Bias serves as the center

P03.10 (Analog Frequency Command for Reverse Run)

- 0: Negative frequency is not valid. Forward and reverse run is controlled by digital keyboard or external terminals.
- 1: Negative frequency is valid. Positive frequency = forward run; negative frequency = reverse run. Direction can not be switched by digital keypad or external terminal control.

Bias and Gain Example 31:

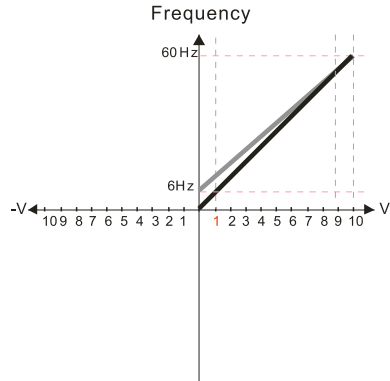

P03.07–P03.08 (Positive/Negative Bias Mode)

- 0: No bias
- 1: Lower than or equal bias
- 2: Greater than or equal to bias
- 3: The absolute value of the bias voltage while serving as the center
- 4: Bias serves as the center

P03.10 (Analog Frequency Command for Reverse Run)

- 0: Negative frequency is not valid. Forward and reverse run is controlled by digital keyboard or external terminals.
- 1: Negative frequency is valid. Positive frequency = forward run; negative frequency = reverse run. Direction can not be switched by digital keypad or external terminal control.

Calculate the bias:

$$\frac{60-6\text{Hz}}{10\text{V}} = \frac{6-0\text{Hz}}{(0-X\text{V})} \quad X\text{V} = \frac{100}{-9} = -11.1\text{V} \quad \therefore 0.03 = \frac{-1.11}{10} \times 100\% = -11.1\%$$

Calculate the gain:

$$P03.11 = \frac{10\text{V}}{11.1\text{V}} \times 100\% = 90.0\%$$

Bias and Gain Example 32:

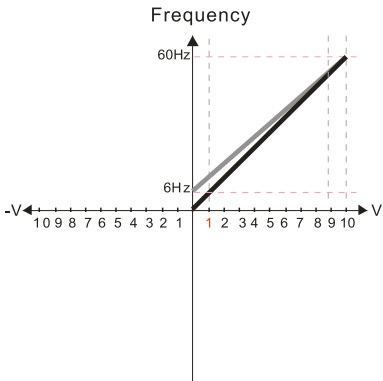

P03.07–P03.08 (Positive/Negative Bias Mode)

- 0: No bias
- 1: Lower than or equal bias
- 2: Greater than or equal to bias
- 3: The absolute value of the bias voltage while serving as the center
- 4: Bias serves as the center

P03.10 (Analog Frequency Command for Reverse Run)

- 0: Negative frequency is not valid. Forward and reverse run is controlled by digital keyboard or external terminals.
- 1: Negative frequency is valid. Positive frequency = forward run; negative frequency = reverse run. Direction can not be switched by digital keypad or external terminal control.

Calculate the bias:

$$\frac{60-6\text{Hz}}{10\text{V}} = \frac{6-0\text{Hz}}{(0-X\text{V})} \quad X\text{V} = \frac{100}{-9} = -11.1\text{V} \quad \therefore 0.03 = \frac{-1.11}{10} \times 100\% = -11.1\%$$

Calculate the gain:

$$P03.11 = \frac{10\text{V}}{11.1\text{V}} \times 100\% = 90.0\%$$

ANALOG INPUT PARAMETER EXAMPLE 1: STANDARD OPERATION

This example illustrates the default operation of the drive. The example is given to further illustrate the use of the analog calculations. The full range of the analog input signal corresponds to the full forward frequency range of the AC drive.

- Minimum Frequency Reference = 0Hz
- Maximum Frequency Reference = 60Hz



For AI1 and AI2: P03.50 (Analog Input Curve) must be set to zero (Normal Curve) to enable bias and gain calculations.

Calculations

A) **Drive Maximum Output Frequency** = P01.00 = (1750 rpm / 1750 rpm) x 60Hz = 60Hz

B) **Analog Bias %** = 0%

Analog Input (AIx)	AI1	AI2
Bias Parameter	P03.03	P03.04

C) **Analog Gain %** = [(60Hz - 0Hz) / 60Hz] x 100 = 100%

Analog Input	AI1	AI2
Gain Parameter	P03.11	P03.12

D) **Mid-point Frequency** = [(60Hz - 0Hz) / 2] + 0Hz = 30Hz

Parameter Settings

Analog Input	AI1 or	AI2	Parameter Settings
Bias Parameter	P03.03	P03.04	0.0%
Pos/Neg Bias Parameter	P03.07	P03.08	0: No Bias
Gain Parameter	P03.11	P03.12	100.0%
Reverse Setting Parameter	P03.10		0: No Neg Freq
Curve Parameter	P03.50		0
Drive Max Output Freq	P01.00		60Hz

Results

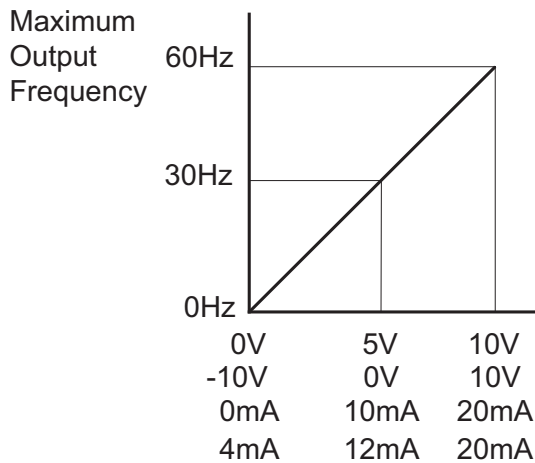

**ANALOG INPUT PARAMETER EXAMPLE 2:
STANDARD OPERATION WITH INCREASED MAXIMUM OUTPUT FREQUENCY**

This example illustrates how to run the motor faster than its base speed. For this purpose, the only required parameter change is P01.00, Drive Maximum Output Frequency. (Motors produce reduced output torque when running above their base speed.)



WARNING: THE DRIVE MAXIMUM OUTPUT FREQUENCY PARAMETER (P01.00) SHOULD NEVER EXCEED THE MAXIMUM SPEED RATING FOR THE MOTOR YOU ARE USING. IF THIS INFORMATION IS NOT READILY AVAILABLE, CONSULT YOUR MOTOR MANUFACTURER.

The analog input adjustment parameters can remain defaulted, as determined by the analog input calculations shown below. The increased Drive Maximum Output Frequency can be obtained regardless of whether the Source of Frequency Command (P03.00 or P03.01) is an analog input or one of the other sources, such as the keypad, RS-485 communication interface, jog, or multi-speed settings.

- Minimum Frequency Reference = 0Hz
- Maximum Frequency Reference = 70Hz
- Motor Maximum Output Speed = 2042 rpm



For AI1 and AI2: P03.50 (Analog Input Curve) must be set to zero (Normal Curve) to enable bias and gain calculations.

Calculations

- A) **Drive Maximum Output Frequency** = P01.00 = (2042 rpm / 1750 rpm) x 60Hz = 70Hz
 B) **Analog Bias %** = 0%

Analog Input (AIx)	AI1	AI2
Bias Parameter	P03.03	P03.04

- C) **Analog Gain %** = [(70Hz - 0Hz) / 70Hz] x 100 = 100% = AIx Input Gain

Analog Input	AI1	AI2
Gain Parameter	P03.11	P03.12

- D) **Mid-point Frequency** = [(70Hz - 0Hz) / 2] + 0Hz = 35Hz

Parameter Settings

Analog Input	AI1 or	AI2	Parameter Settings
Bias Parameter	P03.03	P03.04	0.0%
Pos/Neg Bias Parameter	P03.07	P03.08	0: No Bias
Gain Parameter	P03.11	P03.12	100.0%
Reverse Setting Parameter	P03.10		0: No Neg Freq
Curve Parameter	P03.50		0
Drive Max Output Freq	P01.00		70Hz

Results

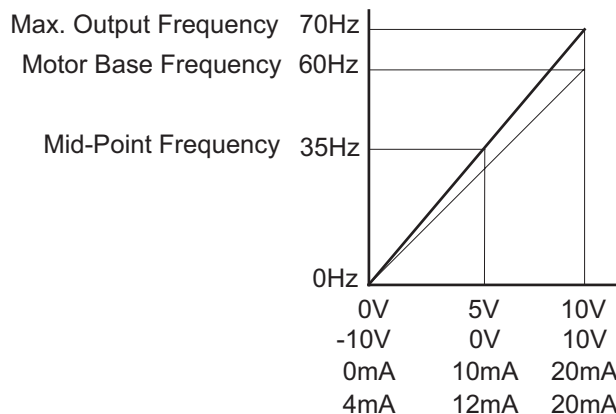

ANALOG INPUT PARAMETER EXAMPLE 3: POSITIVE OFFSET

In this example, the Analog Input will have a positive offset while still using the full scale of the potentiometer or other analog signal device. When the analog signal is at its lowest value (-10V, 0V, 0mA, or 4mA), the set-point frequency will be at 10Hz. When analog signal is at its maximum value (10V or 20mA), the set-point frequency will be 60Hz. This example will use the three point curve method.

- Minimum Frequency Reference @0V = 10Hz (10/60=16%)
- Mid-point Frequency Reference @5V = 35Hz (35/60=58%)
- Maximum Frequency Reference @10V = 60Hz (60/60=100%)



For AI1 and AI2: **P03.50 (Analog Input Curve) must be set to 1, 2, or 3 to enable three point curve calculations.**

Parameter Settings

Analog Input	AI1	AI2	Parameter Settings
Polarity	0-10 V	Positive (+)	
Curve Selection	P03.50 = 1 or 3	P03.50 = 2 or 3	1, 2, or 3
Term Input Selection	P03.28=0	P03.29=0,1,2	0, 1, or 2
Low V/A	P03.63	P03.57	0V
Low Hz Percent	P03.64	P03.58	16%
Mid V/A	P03.65	P03.59	5V
Mid Hz Percent	P03.66	P03.60	58%
High V/A	P03.67	P03.61	10V
High Hz Percent	P03.68	P03.62	100%

Results

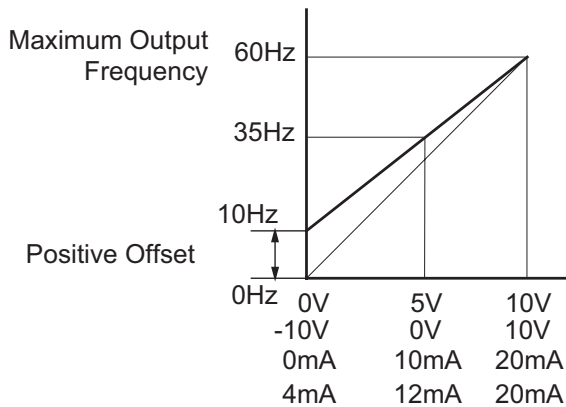

ANALOG INPUT PARAMETER EXAMPLE 4: FORWARD AND REVERSE OPERATION

In this example, the potentiometer (or other analog signal device) is programmed to run a motor full-speed in both forward and reverse directions. The frequency reference will be 0Hz when the potentiometer is positioned at mid-point of its scale. This example will be shown using the three point curve parameters.



Utilize negative frequency percentage values in the proportional settings for reverse motion. Use positive percentage values for forward motion.

- Minimum Frequency Reference @0V = -60Hz (-100%)(reverse)
- Mid-point Frequency Reference @5V = 0Hz (0%)
- Maximum Frequency Reference @10V = 60Hz (100%)



For AI1 and AI2: P03.50 (Analog Input Curve) must be set to 1, 2, or 3 to enable three point curve parameters.

Parameter Settings

Analog Input	AI1	AI2	Parameter Settings
Polarity	0–10 V	Positive (+)	
Curve Selection	P03.50 = 1 or 3	P03.50 = 2 or 3	1, 2, or 3
Term Input Selection	P03.28=0	P03.29=0,1,2	0, 1, or 2
Low V/A	P03.63	P03.57	0V
Low Hz Percent	P03.64	P03.58	-100%
Mid V/A	P03.65	P03.59	5V
Mid Hz Percent	P03.66	P03.60	0%
High V/A	P03.67	P03.61	10V
High Hz Percent	P03.68	P03.62	100%

Results

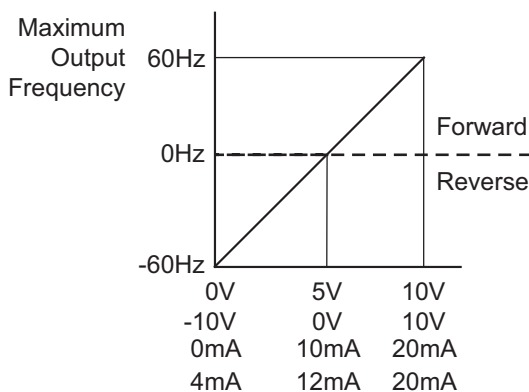

ANALOG INPUT PARAMETER EXAMPLE 5: FORWARD RUN/REVERSE JOG

This example shows an application in which the drive runs full-speed forward and jogs in reverse. The full scale of the potentiometer (or other analog signal device) will be used.



Use negative frequency percentage values in the proportional settings for reverse motion. Use positive percentage values for forward motion.

- Minimum Frequency Reference @0V = -15Hz (-15/60 = -25%)(reverse)
- Mid-Point Frequency Reference @5V = 22.5 Hz (22.5/60 = 37.5%)
- Maximum Frequency Reference @10V = 60Hz (60/60 = 100%)



For AI1 and AI2: **P03.50 (Analog Input Curve) must be set to 1, 2, or 3 to enable three point curve parameters.**

Parameter Settings

Analog Input	AI1	AI2	Parameter Settings
Polarity	0-10 V	Positive (+)	
Curve Selection	P03.50 = 1 or 3	P03.50 = 2 or 3	1, 2, or 3
Term Input Selection	P03.28=0	P03.29=0,1,2	0, 1, or 2
Low V/A	P03.63	P03.57	0V
Low Hz Percent	P03.64	P03.58	-25%
Mid V/A	P03.65	P03.59	5V
Mid Hz Percent	P03.66	P03.60	37.5%
High V/A	P03.67	P03.61	10V
High Hz Percent	P03.68	P03.62	100%

Results

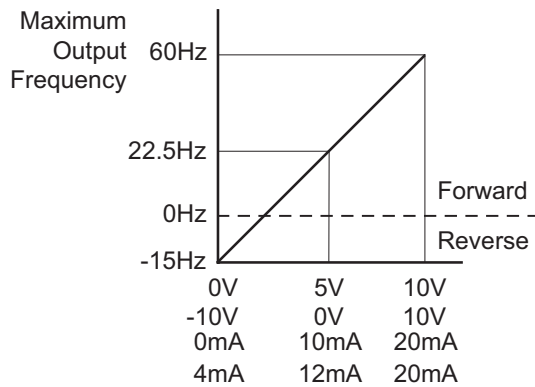

ANALOG INPUT PARAMETER EXAMPLE 6: REDUCED ANALOG GAIN

This example shows how to limit the Maximum Frequency Reference by reducing the Analog Input Gain. When the Analog Input is at its maximum value (10V or 20mA), the set-point frequency will be 50Hz. However, this reduced maximum frequency applies only to an Analog Input Source of Frequency Command. The Maximum Output Frequency can still go to 60Hz if controlled from the Keypad, RS-485 interface, Jog Command, or Multi-Speed settings. For this example, the only required parameter change is P03.11 or P03.12, Gain parameter.

- Minimum Frequency Reference = 0Hz
- Maximum Frequency Reference = 50Hz



For AI1 and AI2: P03.50 (Analog Input Curve) must be set to zero (Normal Curve) to enable bias and gain calculations.

Calculations

- A) **Drive Maximum Output Frequency** = P01.00 = (1750 rpm / 1750 rpm) x 60Hz = 60Hz
- B) **Analog Bias %** = 0%

Analog Input (AIx)	AI1	AI2
Bias Parameter	P03.03	P03.04

- C) **Analog Gain %** = [(50Hz - 0Hz) / 60Hz] x 100 = 83.3% = AIx Input Gain

Analog Input	AI1	AI2
Gain Parameter	P03.11	P03.12

- D) **Mid-point Frequency** = [(50Hz - 0Hz) / 2] + 0Hz = 25Hz

Parameter Settings

Analog Input	AI1 or	AI2	Parameter Settings
Polarity	Positive (+)	Positive (+)	
Bias Parameter	P03.03	P03.04	0.0%
Pos/Neg Bias Parameter	P03.07	P03.08	0: No Bias
Gain Parameter	P03.11	P03.12	83.3%
Reverse Setting Parameter	P03.10		0: No Neg Freq
Curve Parameter	P03.50		0

Results

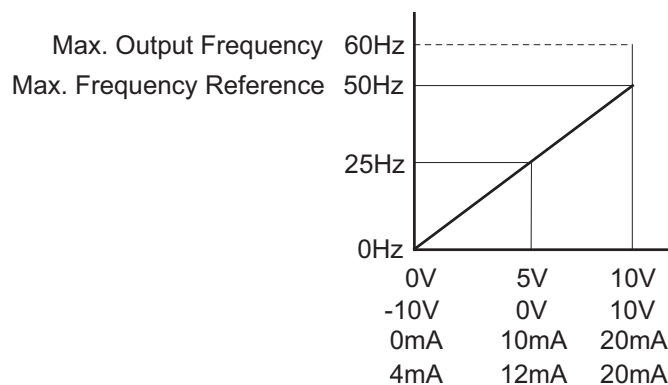

ANALOG INPUT PARAMETER EXAMPLE 7: POSITIVE OFFSET WITH REDUCED ANALOG GAIN

This example illustrates how to provide a positive offset of the Analog Input, while using the full scale of the potentiometer or other analog device. At the same time, the Maximum Frequency Reference is limited by reducing the Analog Input Gain.

When the analog signal is at its lowest value, the set-point frequency will be at 11.5Hz. When the analog signal is at its maximum value, the set-point frequency will be 39.6Hz.

- Minimum Frequency Reference @0V = 11.5 Hz (11.5/60 = 19%)
- Mid-point Frequency Reference @5V = 22.5 Hz (22.5/60 = 37.5%)
- Maximum Frequency Reference @10V = 39.6 Hz (39.6/60 = 66%)



For AI1 and AI2: **P03.50 (Analog Input Curve) must be set to 1, 2, or 3 to enable three point curve parameters.**

Parameter Settings

Analog Input	AI1	AI2	Parameter Settings
Polarity	0–10 V	Positive (+)	
Curve Selection	P03.50 = 1 or 3	P03.50 = 2 or 3	1, 2, or 3
Term Input Selection	P03.28=0	P03.29=0,1,2	0, 1, or 2
Low V/A	P03.63	P03.57	0V
Low Hz Percent	P03.64	P03.58	19%
Mid V/A	P03.65	P03.59	5V
Mid Hz Percent	P03.66	P03.60	37.5%
High V/A	P03.67	P03.61	10V
High Hz Percent	P03.68	P03.62	66%

Results

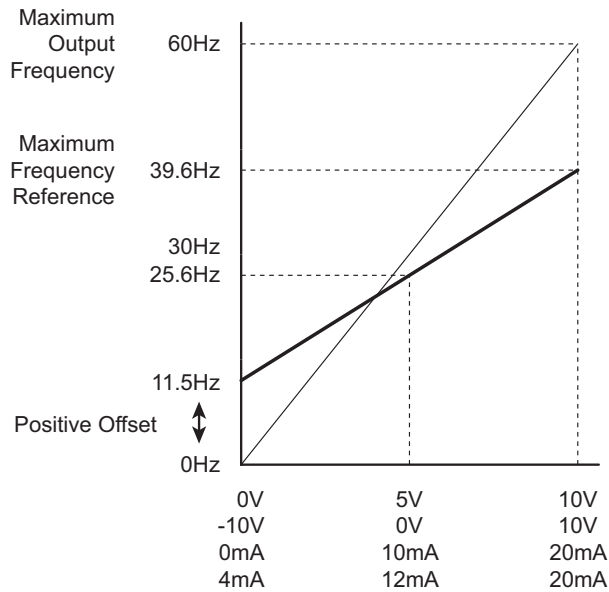

ANALOG INPUT PARAMETER EXAMPLE 8: TRIM

This example illustrates trimming the output frequency of the drive.

- Minimum Frequency Reference = 0Hz
- Maximum Frequency Reference = 45Hz
- Actual Drive Output Frequency (when P4.08 = 4) = Frequency Command - Trim Reference Frequency
- Trim Frequency Reference P4.07 = 15Hz
(use comms or keypad to adjust this value based on the application needs)



For AI1 and AI2: P03.50 (Analog Input Curve) must be set to zero (Normal Curve) to enable bias and gain calculations.

Calculations

A) Drive Maximum Output Frequency = P01.00 = (1750 rpm / 1750 rpm) x 60Hz = 60Hz

B) Analog Bias % = 25%

Analog Input (AIx)	AI1	AI2
Bias Parameter	P03.03	P03.04

C) Analog Gain % = [(60Hz - 0Hz) / 60Hz] x 100 = 100%

Analog Input	AI1	AI2
Polarity	Positive (+)	Positive (+)
Gain Parameter	P03.11	P03.12

D) Mid-point Frequency = [(45Hz - 0Hz) / 2] + 0Hz = 22.5 Hz

Parameter Settings

Analog Input	AI1 or	AI2	Parameter Settings
Polarity	Positive (+)	Positive (+)	
Bias Parameter	P03.03	P03.04	25%
Pos/Neg Bias Parameter	P03.07	P03.08	3: ABS of Bias
Gain Parameter	P03.11	P03.12	100.0%
Reverse Setting Parameter	P03.10		1: Neg Freq Allowed
Curve Parameter	P03.50		0

Results

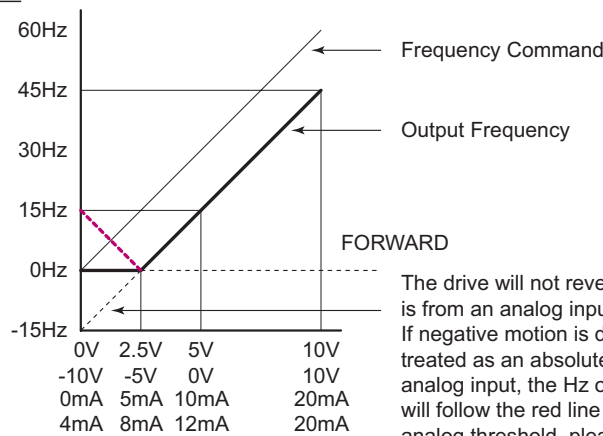

The drive will not reverse direction unless the Frequency Command is from an analog input, and reverse motion is enabled in P03.10. If negative motion is disabled (P03.10=0), the analog signal will be treated as an absolute value. Instead of 0Hz output below 2.5V analog input, the Hz output will be treated as an absolute value and will follow the red line below 2.5V. To establish 0Hz below a specific analog threshold, please see Analog Input Parameter Example 9.

ANALOG INPUT PARAMETER EXAMPLE 9: ZERO VOLTS OUT AT LOW V_{IN}

This example gives 0Hz output through the first 0V~2.5V of Analog Input. The rest of the 2.5V~10V corresponds to 0~45 Hz. This example will use the three point curve method.

- Minimum Frequency Reference @0V = 0Hz (0/60 = 0%)
- Mid-point Frequency Reference @5V = 0Hz (0/60 = 0%)
- Maximum Frequency Reference @10V = 45Hz (45/60 = 75%)



For AI1 and AI2: **P03.50 (Analog Input Curve) must be set to 1, 2, or 3 to enable three point curve parameters.**

Parameter Settings

Analog Input	AI1	AI2	Parameter Settings
Polarity	0-10 V	Positive (+)	
Curve Selection	P03.50 = 1 or 3	P03.50 = 2 or 3	1, 2, or 3
Term Input Selection	P03.28=0	P03.29=0,1,2	0, 1, or 2
Low V/A Input	P03.63	P03.57	0V
Low Hz Percent	P03.64	P03.58	0%
Mid V/A Input	P03.65	P03.59	2.5V
Mid Hz Percent	P03.66	P03.60	0%
High V/A Input	P03.67	P03.61	10V
High Hz Percent	P03.68	P03.62	75%

Results

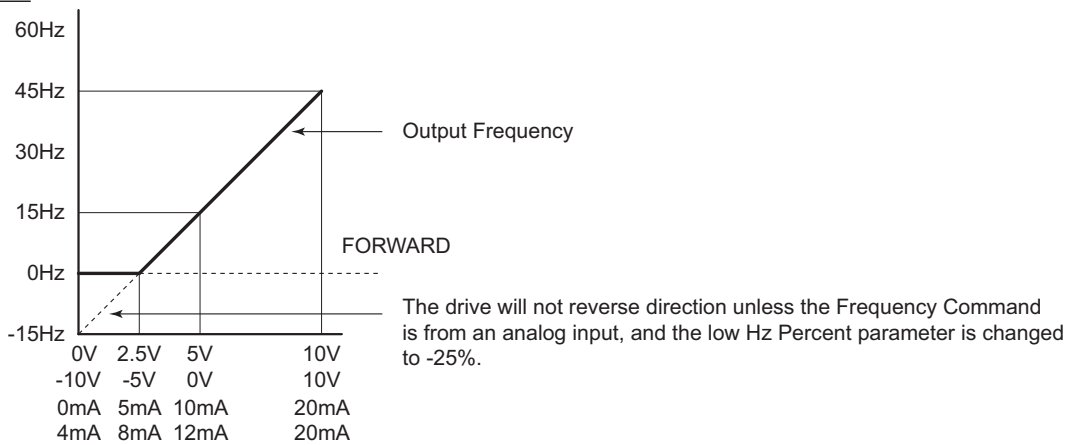

ANALOG INPUT PARAMETER EXAMPLE 10: INVERSE ANALOG SPEED REFERENCE

This example illustrates the use of an inverse analog speed reference to the drive. The minimum analog reference value corresponds to the full forward output frequency of the drive. In this example, only the Pos/Neg Bias Parameter must be changed from default.

- Minimum Frequency Reference = 60Hz
(drive output frequency at the minimum analog input reference, 0V)
- Maximum Frequency Reference = 0Hz
(drive output frequency at the maximum analog input reference, 10V)



For AI1 and AI2: **P03.50 (Analog Input Curve) must be set to zero (Normal Curve) to enable bias and gain calculations.**

Calculations (see [page 4-116](#) for formulas)

A) **Drive Maximum Output Frequency** = P01.00 = (1750 rpm / 1750 rpm) x 60Hz = 60Hz

B) **Analog Bias %** = 100%

Analog Input (AIx)	AI1	AI2
Bias Parameter	P03.03	P03.04

C) **Analog Gain %** = [(0Hz - 60Hz) / 60Hz] x 100 = -100%

Analog Input	AI1	AI2
Gain Parameter	P03.11	P03.12

D) **Mid-point Frequency** = [(60Hz - 0Hz) / 2] + 0Hz = 30Hz

Parameter Settings

Analog Input	AI1 or	AI2 or	Parameter Settings
Polarity	Positive (+)	Positive (+)	
Bias Parameter	P03.03	P03.04	100.0%
Pos/Neg Bias Parameter	P03.07	P03.08	2: Greater than or equal to
Gain Parameter	P03.11	P03.12	100.0%
Reverse Setting Parameter	P03.10		0: No Neg Freq
Curve Parameter	P03.50		0
Drive Max Output Freq	P01.00		60Hz

Results

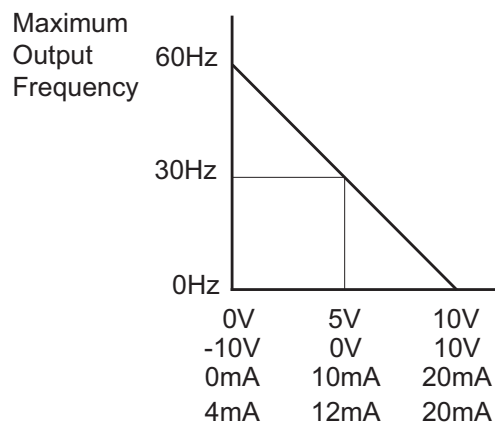

ANALOG INPUT PARAMETER EXAMPLE 11: FORWARD AND REVERSE OPERATION WITH -10V TO +10V INPUT

In this example, the potentiometer (or other analog signal device) is programmed to run a motor full-speed in both forward and reverse directions using a -10V to +10V analog input. The frequency reference will be 0Hz when the potentiometer is positioned at mid-point of its scale (0V). When using -10V to +10V the three point curve method is used. This requires using parameters P03.62 – P03.68 for 0 to +10V scaling and P03.69 – P03.74 for 0 to -10V scaling. This is effectively a six point curve.

- Minimum Frequency Reference @-10V = -60Hz (-60/60 = -100%)(reverse)
- Mid-point Frequency Reference @-5V = -30Hz (-30/60 = -50%)(reverse)
- Maximum Frequency Reference @0V = 0Hz (0/60 = 0%)
- Minimum Frequency Reference @0V = 0Hz (0/60 = 0%)
- Mid-point Frequency Reference @5V = 30Hz (30/60 = 50%)
- Maximum Frequency Reference @10V = 60Hz (60/60 = 100%)



For AI1 and AI2: **P03.50 (Analog Input Curve) must be set to 1, 2, or 3 to enable three point curve parameters.**

Parameter Settings

Analog Input	AI1	Parameter Settings
Polarity	-10V to +10V	
Curve Selection	P3.50	1 or 3
Term Input Select	P3.28	3
Low Point Input Value	03.63	0
Low Proportional % Out	03.64	0
Middle Point Input Value	03.65	5
Middle Proportional % Out	03.66	-50%
High Point Input Value	03.67	10
High Proportional % Out	03.68	100%
High Point Input Value	03.69	0
High Proportional % Out	03.70	0
Middle Point Input Value	03.71	-5
Middle Proportional % Out	03.72	-50%
Low Point Input Value	03.73	-10
Low Proportional % Out	03.74	-100%

Results

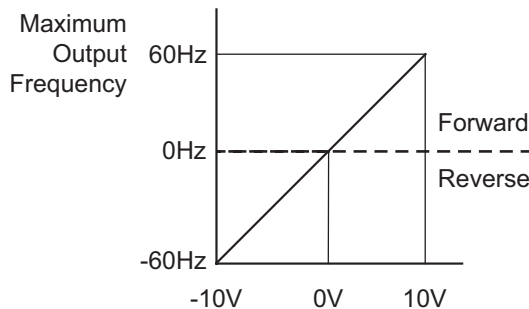

GROUP P04.xx DETAILS – MULTI-STEP SPEED PARAMETERS

		Type	Hex Addr	Dec Addr
P04.00	1st Step Speed Frequency	◆R/W	0400	41025
P04.01	2nd Step Speed Frequency	◆R/W	0401	41026
P04.02	3rd Step Speed Frequency	◆R/W	0402	41027
P04.03	4th Step Speed Frequency	◆R/W	0403	41028
P04.04	5th Step Speed Frequency	◆R/W	0404	41029
P04.05	6th Step Speed Frequency	◆R/W	0405	41030
P04.06	7th Step Speed Frequency	◆R/W	0406	41031
P04.07	8th Step Speed Frequency	◆R/W	0407	41032
P04.08	9th Step Speed Frequency	◆R/W	0408	41033
P04.09	10th Step Speed Frequency	◆R/W	0409	41034
P04.10	11th Step Speed Frequency	◆R/W	040A	41035
P04.11	12th Step Speed Frequency	◆R/W	040B	41036
P04.12	13th Step Speed Frequency	◆R/W	040C	41037
P04.13	14th Step Speed Frequency	◆R/W	040D	41038
P04.14	15th Step Speed Frequency	◆R/W	040E	41039
	<i>Range/Units (Format: 16-bit unsigned)</i>		<i>Default</i>	
	0.00–599.00 Hz		0.00	

Use the multi-function input terminals (refer to settings 1–4 of P02.01–P02.07 Multi-function Input Command) to select the multi-step speed command (the maximum is 15th step speed). P04.00 to P04.14 sets the multi-step speed (frequency) as shown in the following diagram.

- The external terminal/digital keypad/communication controls the RUN and STOP commands with P00.21.
- You can set each multi-step speed between 0.00–599.00 Hz during operation.
- Explanation for the timing diagram of the multi-step speed and external terminals.
The related parameter settings are:
 - a) P04.00–P04.14: sets the 1st–15th multi-step speed (to set the frequency of each step speed).
 - b) P02.01–P02.07: sets the multi-function input terminals (multi-step speed command 1–4).

Related parameters:

- P01.22 JOG frequency setting
- P02.01 multi-function input command 1 (DI1)
- P02.02 multi-function input command 2 (DI2)
- P02.03 multi-function input command 3 (DI3)
- P02.04 multi-function input command 4 (DI4)

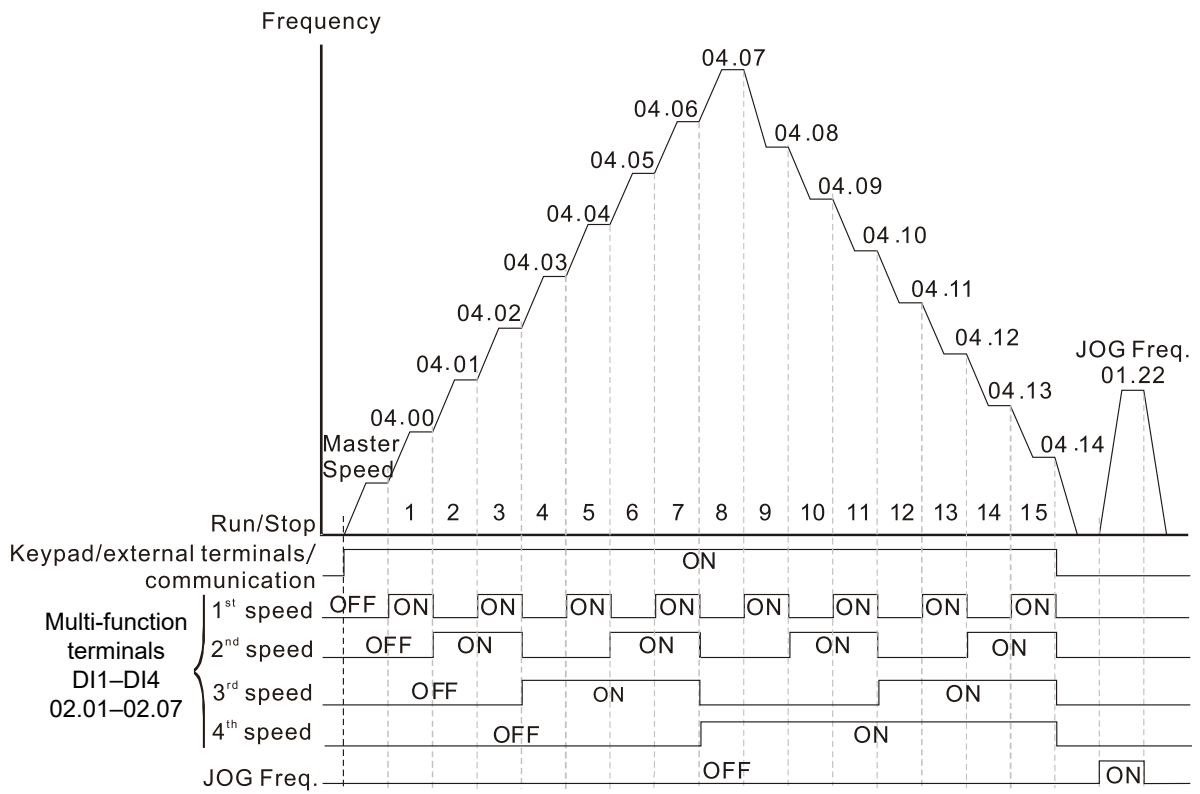

Speed Selection through External Terminals

		Type	Hex Addr	Dec Addr
<u>P04.50</u>	PLC Buffer 0	◆R/W	0432	41075
<u>P04.51</u>	PLC Buffer 1	◆R/W	0433	41076
<u>P04.52</u>	PLC Buffer 2	◆R/W	0434	41077
<u>P04.53</u>	PLC Buffer 3	◆R/W	0435	41078
<u>P04.54</u>	PLC Buffer 4	◆R/W	0436	41079
<u>P04.55</u>	PLC Buffer 5	◆R/W	0437	41080
<u>P04.56</u>	PLC Buffer 6	◆R/W	0438	41081
<u>P04.57</u>	PLC Buffer 7	◆R/W	0439	41082
<u>P04.58</u>	PLC Buffer 8	◆R/W	043A	41083
<u>P04.59</u>	PLC Buffer 9	◆R/W	043B	41084
<u>P04.60</u>	PLC Buffer 10	◆R/W	043C	41085
<u>P04.61</u>	PLC Buffer 11	◆R/W	043D	41086
<u>P04.62</u>	PLC Buffer 12	◆R/W	043E	41087
<u>P04.63</u>	PLC Buffer 13	◆R/W	043F	41088
<u>P04.64</u>	PLC Buffer 14	◆R/W	0440	41089
<u>P04.65</u>	PLC Buffer 15	◆R/W	0441	41090
<u>P04.66</u>	PLC Buffer 16	◆R/W	0442	41091
<u>P04.67</u>	PLC Buffer 17	◆R/W	0443	41092
<u>P04.68</u>	PLC Buffer 18	◆R/W	0444	41093
<u>P04.69</u>	PLC Buffer 19	◆R/W	0445	41094
	<i>Range/Units (Format: 16-bit unsigned)</i>	<i>Default</i>		
	0-65535	0		

You can combine the PLC buffer with the built-in PLC function for a variety of applications.

GROUP P05.xx DETAILS – MOTOR PARAMETERS

In this parameter group, the following are abbreviations for different types of motors:

- IM: Induction motor
- PM: Permanent magnet synchronous AC motor
- IPM: Interior permanent magnet synchronous AC motor
- SPM: Surface permanent magnet synchronous AC motor

	Type	Hex Addr	Dec Addr
P05.00 Motor Parameter Auto-tuning	R/W	0000	41281
<i>Range/Units (Format: 16-bit binary)</i>	<i>Default</i>		
0: No function	0		
1: Adv. rolling auto-tuning for IM motor flux curve (FOC/TQC)			
2: Static test for induction motor (IM)			
5: Rolling auto-tuning for PM (IPM / SPM)			
6: Simple rolling auto-tuning for induction motor (IM)			
12: FOC/TQC sensorless inertia estimation (IM)			
13: Static Auto-tuning for PM (IPM/SPM)			

Setting 1 can be used for P00.10=2 Torque mode and P00.11=5 FOC sensorless mode only.

Setting 6 can be used for induction motor auto tune in these speed modes: P00.11=0, 1 or 2.

Drive motion will occur during these tests.

When auto tuning is in process, “TUN” will display on the drive keypad.

For PM motors, tune motor with no load connected. P05.00=5 provides more accurate calculation of the Ke parameter (P05.43) based on actual motor rotation. When P05.00=13, the Ke parameter is calculated based on the motor power, current and rotor speed.

See Adjustment and Applications section for detailed tuning procedures.

	Type	Hex Addr	Dec Addr
P05.01 Full-load Current for Induction Motor 1 (A)	Read	0501	41282
<i>Range/Units (Format: 16-bit unsigned)</i>	<i>Default</i>		
10–120 % of the drive’s rated current	Model dependent		

Sets this value according to the rated current of the motor as indicated on the motor nameplate. The default is 90% of the drive’s rated current.

Example:

The rated current for a 7.5 hp (5.5 kW) motor is 25A. The default is 22.5 A.

The setting range is 2.5–30 A (25 × 10% = 2.5 A and 25 × 120% = 30A).

	Type	Hex Addr	Dec Addr
P05.02 Rated Power for Induction Motor 1 (kW)	◆R/W	0502	41283
<i>Range/Units (Format: 16-bit unsigned)</i>	<i>Default</i>		
0.00–655.35 kW	Model dependent		

P05.02 sets the rated power for motor 1. The default is the drive’s power value.

	<u>Type</u>	<u>Hex Addr</u>	<u>Dec Addr</u>
P05.03 Rated Speed for Induction Motor 1 (rpm)	◆R/W	0503	41284
<u>Range/Units (Format: 16-bit unsigned)</u>	<u>Default</u>		
0–xxxxx rpm (Depending on the motor’s number of poles) 1710 (60Hz 4 poles); 1410 (50Hz 4 poles)	Dependent on the motor’s number of poles		

P05.03 sets the rated speed for the motor as indicated on the motor nameplate.

This parameter works in conjunction with the Number of Poles and Hertz. Set up P01.01 and P05.04 before setting up P05.03 to ensure that the motor operates normally.

	<u>Type</u>	<u>Hex Addr</u>	<u>Dec Addr</u>
P05.04 Number of Poles for Induction Motor 1	R/W	0504	41285
<u>Range/Units (Format: 16-bit unsigned)</u>	<u>Default</u>		
2–20	4		

P05.04 sets the number of poles for the motor (must be an even number).

	<u>Type</u>	<u>Hex Addr</u>	<u>Dec Addr</u>
P05.05 No-load Current for Induction Motor 1 (A)	R/W	0505	41286
<u>Range/Units (Format: 16-bit unsigned)</u>	<u>Default</u>		
0.00–P05.01 default	Model dependent		

The default is 40% of the motor's rated current.

	<u>Type</u>	<u>Hex Addr</u>	<u>Dec Addr</u>
P05.06 Stator Resistance (Rs) for Induction Motor 1	R/W	0506	41287
<u>Range/Units (Format: 16-bit unsigned)</u>	<u>Default</u>		
0.000–65.535 Ω	Model dependent		

	<u>Type</u>	<u>Hex Addr</u>	<u>Dec Addr</u>
P05.07 Rotor Resistance (Rr) for Induction Motor 1	R/W	0507	41288
<u>Range/Units (Format: 16-bit unsigned)</u>	<u>Default</u>		
0.000–65.535 Ω	0.000		

	<u>Type</u>	<u>Hex Addr</u>	<u>Dec Addr</u>
P05.08 Magnetizing Inductance (Lm) for Induction Motor 1	R/W	0508	41289
P05.09 Stator Inductance (Lx) for Induction Motor 1	R/W	0509	41290
<u>Range/Units (Format: 16-bit unsigned)</u>	<u>Default</u>		
0.0–6553.5 mH	0.0		

	<u>Type</u>	<u>Hex Addr</u>	<u>Dec Addr</u>
P05.13 Full-load Current for Induction Motor 2 (A)	R/W	050D	41294
<u>Range/Units (Format: 16-bit unsigned)</u>	<u>Default</u>		
10–120 % of the drive’s rated current	Model dependent		

Set P05.13 according to the rated current of the motor as indicated on the motor nameplate. The default is 90% of the drive’s rated current.

Example:

The rated current for a 7.5 hp (5.5 kW) motor is 25A. The default is 22.5 A.

The setting range is 2.5–30 A ($25 \times 10 \% = 2.5$ A and $25 \times 120 \% = 30$ A).

	Type	Hex Addr	Dec Addr
P05.14 Rated Power for Induction Motor 2 (kW)	◆R/W	050E	41295
<i>Range/Units (Format: 16-bit unsigned)</i>	<i>Default</i>		
0.00–655.35 kW	Model dependent		

P05.14 sets the rated power for motor 2. The default is the drive’s power value.

	Type	Hex Addr	Dec Addr
P05.15 Rated Speed for Induction Motor 2 (rpm)	◆R/W	050F	41296
<i>Range/Units (Format: 16-bit unsigned)</i>	<i>Default</i>		
0–xxxxx rpm (Depending on the motor’s number of poles) 1710 (60Hz 4 poles); 1410 (50Hz 4 poles)	Dependent on the motor’s number of poles		

P05.15 sets the rated speed for the motor as indicated on the motor nameplate.

This parameter works in conjunction with the Number of Poles and Hertz. Set up P01.35 and P05.16 before setting up P05.15 to ensure that the motor operates normally.

	Type	Hex Addr	Dec Addr
P05.16 Number of Poles for Induction Motor 2	R/W	0510	41297
<i>Range/Units (Format: 16-bit unsigned)</i>	<i>Default</i>		
2–20	4		

P05.16 sets the number of poles for the motor (must be an even number).

Check P05.15 for accuracy after changing this value.

	Type	Hex Addr	Dec Addr
P05.17 No-load Current for Induction Motor 2 (A)	R/W	0511	41298
<i>Range/Units (Format: 16-bit unsigned)</i>	<i>Default</i>		
0.00–P05.13 default	Model dependent		

The default is 40% of the motor's rated current.

	Type	Hex Addr	Dec Addr
P05.18 Stator Resistance (Rs) for Induction Motor 2	R/W	0512	41299
<i>Range/Units (Format: 16-bit unsigned)</i>	<i>Default</i>		
0.000–65.535 Ω	Model dependent		

	Type	Hex Addr	Dec Addr
P05.19 Rotor Resistance (Rr) for Induction Motor 2	R/W	0513	41300
<i>Range/Units (Format: 16-bit unsigned)</i>	<i>Default</i>		
0.000–65.535 Ω	0.000		

	Type	Hex Addr	Dec Addr
P05.20 Magnetizing Inductance (Lm) for Induction Motor 2	R/W	0514	41301
P05.21 Stator Inductance (Lx) for Induction Motor 2	R/W	0515	41302
<i>Range/Units (Format: 16-bit unsigned)</i>	<i>Default</i>		
0.0–6553.5 mH	0.0		

	<i>Type</i>	<i>Hex Addr</i>	<i>Dec Addr</i>
P05.22 Multi-motor (Induction) Selection	R/W	0516	41303
<i>Range/Units (Format: 16-bit binary)</i>	<i>Default</i>		
1: Motor 1	1		
2: Motor 2			
3: Motor 3 (VF or SVC control mode only)			
4: Motor 4 (VF or SVC control mode only)			

P05.22 sets the motor operated by the AC motor drive. Multi-motor selection only supports single control mode. For example, when you set motor 1 as SVC control mode, the control mode of motors 2–4 are also set as SVC

	<i>Type</i>	<i>Hex Addr</i>	<i>Dec Addr</i>
P05.23 Frequency for Y-connection /Δ-connection Switch for an Induction Motor	◆R/W	0517	41304
<i>Range/Units (Format: 16-bit unsigned)</i>	<i>Default</i>		
0.00–599.00 Hz	60.00		

	<i>Type</i>	<i>Hex Addr</i>	<i>Dec Addr</i>
P05.24 Y-connection /Δ-connection Switch for an Induction Motor	R/W	0518	41305
<i>Range/Units (Format: 16-bit binary)</i>	<i>Default</i>		
0: Disable	0		
1: Enable			

	<i>Type</i>	<i>Hex Addr</i>	<i>Dec Addr</i>
P05.25 Delay Time for Y-connection/Δ-connection Switch for an Induction Motor	◆R/W	0519	41306
<i>Range/Units (Format: 16-bit unsigned)</i>	<i>Default</i>		
0.000–60.000 sec.	0.200		

You can apply P05.23–P05.25 in wide range motors, and the motor coil executes the Y-connection/ Δ -connection switch as required. The wide range motors are related to the motor design. In general, the motor has higher torque with low speed Y-connection and has higher speed with high speed Δ -connection.

- P05.24 enables and disables the switch of Y-connection/ Δ -connection.
- When you set P05.24 to 1, the drive uses the P05.23 setting and current motor frequency, and switches the current motor to Y-connection or Δ -connection. You can switch the relevant motor parameter settings simultaneously.
- P05.25 sets the switch delay time of Y-connection/ Δ -connection.
- When the output frequency reaches the Y-connection/ Δ -connection switch frequency, the drive delays according to P05.25 before activating the multi-function output terminals.

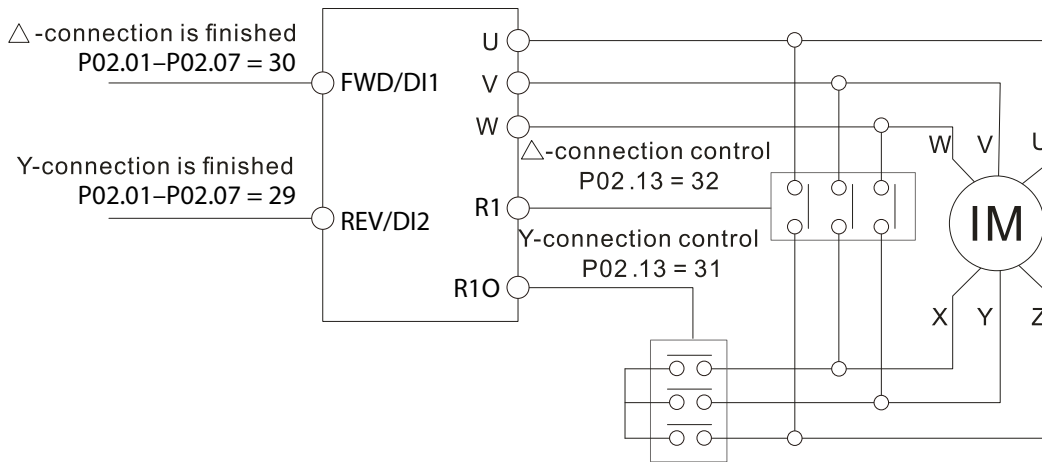

- Y- Δconnection switch: can be used for wide range motor
- Y -connection for low speed: higher torque can be used for rigid tapping
- Δ-connection for high speed: higher speed can be used for high-speed drilling

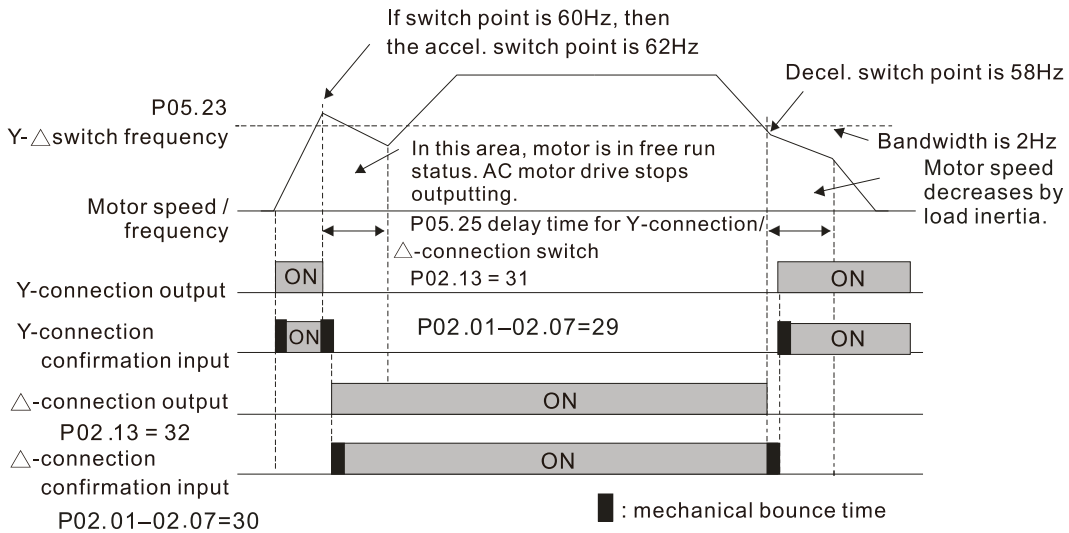

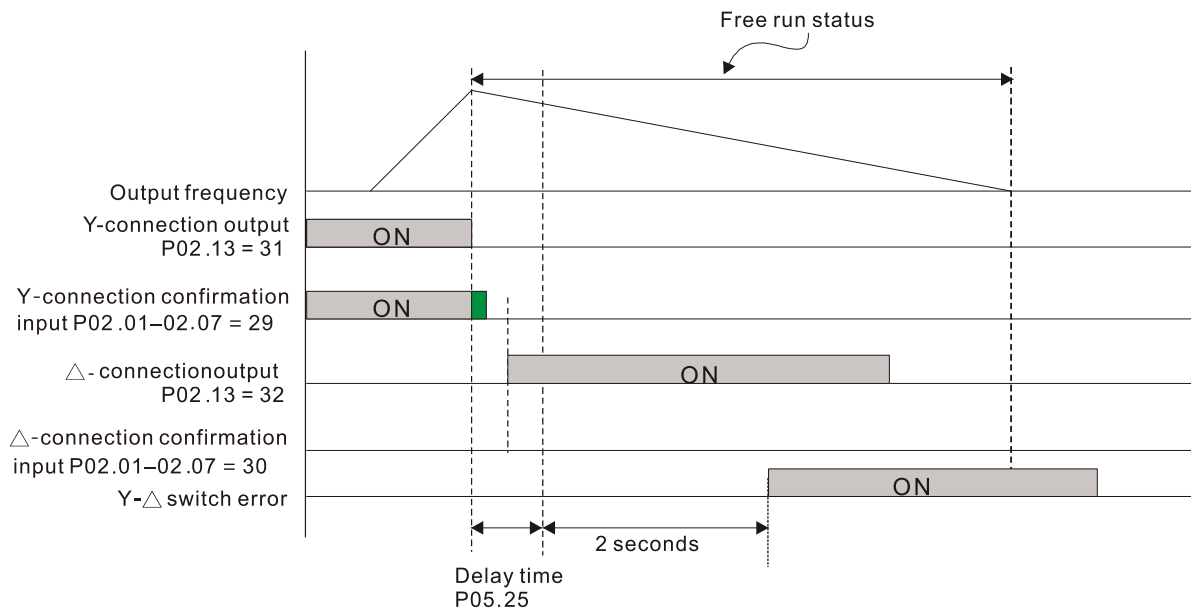

	Type	Hex Addr	Dec Addr
P05.26 <i>Accumulated Watt-second for a Motor (W-msec.)</i>	Read	051A	41307
P05.27 <i>Accumulated Watt-second for a Motor (W-sec. or joule)</i>	Read	051B	41308
P05.28 <i>Accumulated Watt-hour for a Motor (W-hour)</i>	Read	051C	41309
P05.29 <i>Accumulated Watt-hour for a Motor (kW-hour)</i>	Read	051D	41310
P05.30 <i>Accumulated Watt-hour for a Motor (MW-hour)</i>	Read	051E	41311
<i>Range/Units (Format: 16-bit unsigned)</i>	<i>Default</i>		
Read only	0		

Parameters P05.26–P05.30 record the amount of power the motors consume. The accumulation begins when the drive is activated and the record is saved when the drive stops or turns OFF. The amount of consumed watts continues to accumulate when the drive is activated again. To clear the accumulation, set P00.02 to 5 to return the accumulation record to 0.

- The accumulated total watts of the motor per second = $P05.27 \times 65536 + P05.26$.
Example: When $P05.26 = 2548.1$ and $P05.27 = 15.2$, the accumulated total watts of the motor per second = $15.2 \times 65536 + 2548.1 = 996147.2 + 2548.1 = 998695.3$
- The accumulated total kilowatts of the motor per hour = $P05.30 \times 65536 + P05.29$.
Example: When $P05.29 = 3361.4$ and $P05.30 = 11.2$, the accumulated total kilowatts of the motor per hour = $11.2 \times 65536 + 3361.4 = 734003.2 + 3361.4 = 737364.6$

	Type	Hex Addr	Dec Addr
P05.31 <i>Accumulated Motor Operation Time (minutes)</i>	R/W	051F	41312
<i>Range/Units (Format: 16-bit unsigned)</i>	<i>Default</i>		
0–1439	0		

	Type	Hex Addr	Dec Addr
P05.32 <i>Accumulated Motor Operation Time (days)</i>	R/W	0520	41313
<i>Range/Units (Format: 16-bit unsigned)</i>	<i>Default</i>		
0–65535	0		

Use P05.31 and P05.32 to record the motor operation time. To clear the operation time, set P05.31 and P05.32 to 0. An operation time shorter than 60 seconds is not recorded.

P05.33	Induction Motor (IM) or Permanent Magnet Synchronous AC Motor Selection	<i>Type</i>	<i>Hex Addr</i>	<i>Dec Addr</i>
	<i>Range/Units (Format: 16-bit binary)</i>	R/W	0521	41314
	0: IM (Induction motor) 1: SPM (Surface permanent magnet synchronous AC motor) 2: IPM (Interior permanent magnet synchronous AC motor)	<i>Default</i>		

On SPM motors, magnets are mounted on the exterior of the rotor shaft. On IPM motors, magnets are mounted inside of the rotor shaft.

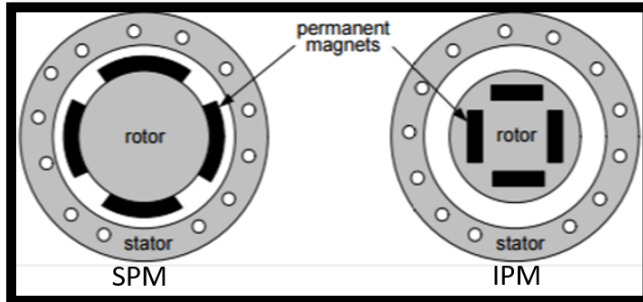

P05.34	Full-load Current for a Permanent Magnet Synchronous AC Motor	<i>Type</i>	<i>Hex Addr</i>	<i>Dec Addr</i>
	<i>Range/Units (Format: 16-bit unsigned)</i>	R/W	0522	41315
	0–120% of the drive’s rated current	<i>Default</i>		Model dependent

P05.35	Rated Power for a Permanent Magnet Synchronous AC Motor	<i>Type</i>	<i>Hex Addr</i>	<i>Dec Addr</i>
	<i>Range/Units (Format: 16-bit unsigned)</i>	R/W	0523	41316
	0.00–655.35 kW	<i>Default</i>		Model dependent

Sets the rated power for the permanent magnet synchronous AC motor. The default is the drive’s power value.

P05.36	Rated Speed for a Permanent Magnet Synchronous AC Motor	<i>Type</i>	<i>Hex Addr</i>	<i>Dec Addr</i>
	<i>Range/Units (Format: 16-bit unsigned)</i>	R/W	0524	41317
	0–65535 rpm	<i>Default</i>		2000

P05.37	Number of Poles for a Permanent Magnet Synchronous AC Motor	<i>Type</i>	<i>Hex Addr</i>	<i>Dec Addr</i>
	<i>Range/Units (Format: 16-bit unsigned)</i>	R/W	0525	41318
	0–65535	<i>Default</i>		10

P05.39	Stator Resistance for a Permanent Magnet Synchronous AC Motor	<i>Type</i>	<i>Hex Addr</i>	<i>Dec Addr</i>
	<i>Range/Units (Format: 16-bit unsigned)</i>	R/W	0527	41320
	0.000–65.535 Ω	<i>Default</i>		0.000

P05.40	Permanent Magnet Synchronous AC Motor Ld	<i>Type</i>	<i>Hex Addr</i>	<i>Dec Addr</i>
	<i>Range/Units (Format: 16-bit unsigned)</i>	R/W	0528	41321
	0.00–655.35 mH	<i>Default</i>		0.00

	<i>Type</i>	<i>Hex Addr</i>	<i>Dec Addr</i>
P05.41 Permanent Magnet Synchronous AC Motor Lq	R/W	0529	41322
<i>Range/Units (Format: 16-bit unsigned)</i>	<i>Default</i>		
0.00–655.35 mH	0.00		

	<i>Type</i>	<i>Hex Addr</i>	<i>Dec Addr</i>
P05.43 Ke parameter of a Permanent Magnet Synchronous AC Motor	R/W	052B	41324
<i>Range/Units (Format: 16-bit unsigned)</i>	<i>Default</i>		
0–65535 V / krpm	0		

	<i>Type</i>	<i>Hex Addr</i>	<i>Dec Addr</i>
P05.64 Full-load Current for Induction Motor 3 (A)	R/W	0540	41345
<i>Range/Units (Format: 16-bit unsigned)</i>	<i>Default</i>		
10–120% of the drive's rated current	Model dependent		

Set this value according to the rated current of the motor as indicated on the motor nameplate. The default is 90% of the drive's rated current.

Example:

The rated current for a 7.5 hp (5.5 kW) motor is 25A. The default is 22.5 A.

The setting range is 2.5–30 A ($25 \times 10\% = 2.5$ A and $25 \times 120\% = 30$ A).

	<i>Type</i>	<i>Hex Addr</i>	<i>Dec Addr</i>
P05.65 Rated Power for Induction Motor 3 (kW)	◆R/W	0541	41346
<i>Range/Units (Format: 16-bit unsigned)</i>	<i>Default</i>		
0.00–655.35 kW	Model dependent		

P05.65 sets the rated power for motor 3. The default is the drive's power value.

	<i>Type</i>	<i>Hex Addr</i>	<i>Dec Addr</i>
P05.66 Rated Speed for Induction Motor 3 (rpm)	◆R/W	0542	41347
<i>Range/Units (Format: 16-bit unsigned)</i>	<i>Default</i>		
0–xxxxx rpm (Depending on the motor's number of poles) 1710 (60Hz 4 poles); 1410 (50Hz 4 poles)	Dependent on the motor's number of poles		

P05.66 sets the rated speed for the motor as indicated on the motor nameplate.

	<i>Type</i>	<i>Hex Addr</i>	<i>Dec Addr</i>
P05.67 Number of Poles for Induction Motor 3	R/W	0543	41348
<i>Range/Units (Format: 16-bit unsigned)</i>	<i>Default</i>		
2–20	4		

P05.67 sets the number of poles for the motor (must be an even number).

Set up P01.54 and P05.66 before setting up P05.67 to ensure that the motor operates normally.

	<i>Type</i>	<i>Hex Addr</i>	<i>Dec Addr</i>
P05.68 No-load Current for Induction Motor 3 (A)	R/W	0544	41349
<i>Range/Units (Format: 16-bit unsigned)</i>	<i>Default</i>		
0.00–P05.64 default	Model dependent		

The default is 40% of the motor's rated current.

	Type	Hex Addr	Dec Addr
P05.69 Stator Resistance (Rs) for Induction Motor 3	R/W	0545	41350
<u>Range/Units (Format: 16-bit unsigned)</u>	<u>Default</u>		
0.000–65.535 Ω	Model dependent		

	Type	Hex Addr	Dec Addr
P05.70 Full-load Current for Induction Motor 4 (A)	R/W	0546	41351
<u>Range/Units (Format: 16-bit unsigned)</u>	<u>Default</u>		
10–120% of the drive’s rated current	Model dependent		

Set this value according to the rated current of the motor as indicated on the motor nameplate. The default is 90% of the drive’s rated current.

Example:

The rated current for a 7.5 hp (5.5 kW) motor is 25A. The default is 22.5 A.

The setting range is 2.5–30 A (25 × 10% = 2.5 A and 25 × 120% = 30A).

	Type	Hex Addr	Dec Addr
P05.71 Rated Power for Induction Motor 4 (kW)	◆R/W	0547	41352
<u>Range/Units (Format: 16-bit unsigned)</u>	<u>Default</u>		
0.00–655.35 kW	Model dependent		

P05.71 sets the rated power for motor 4. The default is the drive’s power value.

	Type	Hex Addr	Dec Addr
P05.72 Rated Speed for Induction Motor 4 (rpm)	◆R/W	0548	41353
<u>Range/Units (Format: 16-bit unsigned)</u>	<u>Default</u>		
0–xxxxx rpm (Depending on the motor’s number of poles) 1710 (60Hz 4 poles); 1410 (50Hz 4 poles)	Dependent on the motor’s number of poles		

P05.72 sets the rated speed for the motor as indicated on the motor nameplate.

	Type	Hex Addr	Dec Addr
P05.73 Number of Poles for Induction Motor 4	R/W	0549	41354
<u>Range/Units (Format: 16-bit unsigned)</u>	<u>Default</u>		
2–20	4		

P05.73 sets the number of poles for the motor (must be an even number).

Set up P01.63 and P05.72 before setting up P05.73 to make sure the motor operates normally.

	Type	Hex Addr	Dec Addr
P05.74 No-load Current for Induction Motor 4 (A)	R/W	054A	41355
<u>Range/Units (Format: 16-bit unsigned)</u>	<u>Default</u>		
0.00–P05.70 default	Model dependent		

The default is 40% of the motor’s rated current.

	Type	Hex Addr	Dec Addr
P05.75 Stator Resistance (Rs) for Induction Motor 4	R/W	054B	41356
<u>Range/Units (Format: 16-bit unsigned)</u>	<u>Default</u>		
0.000–65.535 Ω	Model dependent		

GROUP P06.xx DETAILS – PROTECTION PARAMETERS

	Type	Hex Addr	Dec Addr
P06.00 Low Voltage Level	◆R/W	0600	41537
<i>Range/Units (Format: 16-bit unsigned)</i>	<i>Default</i>		
120V / 230V series: 150.0–220.0 VDC	180.0		
460V series: 300.0–440.0 VDC	360.0		
575V series: 375.0–550.0 VDC	450.0		

P06.00 sets the Low Voltage (LV) level. When the DC bus voltage is lower than P06.00 an LV fault is triggered.

- If the LV fault is triggered during operation, the drive stops output and the motor coasts to a stop. There are three LV faults, LvA (LV during acceleration), Lvd (LV during deceleration), and Lvn (LV in constant speed) that are triggered according to the status of acceleration or deceleration. You must press RESET to clear the LV fault. The drive automatically restarts if set to restart after momentary power loss (refer to P07.06 Restart after Momentary Power Loss and P07.07 Allowed Power Loss Duration for details).
- If the LV fault is triggered when the drive is in STOP status, the drive displays LvS (LV during stop), which is not recorded, and the drive restarts automatically when the input voltage is higher than the LV level +30V (120V/230V series), +60V (460V series) or +75V (575 series).

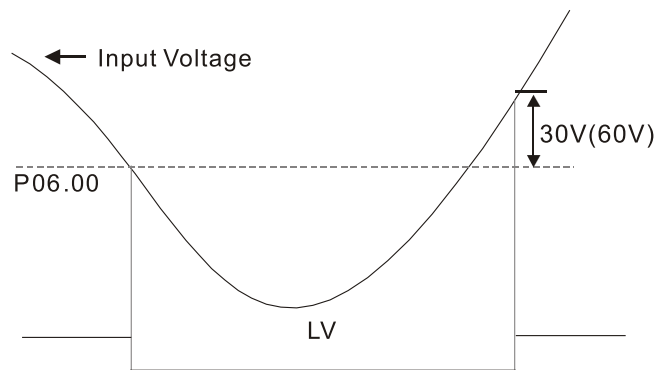

	Type	Hex Addr	Dec Addr
P06.01 Over-voltage Stall Prevention	◆R/W	0601	41538
<i>Range/Units (Format: 16-bit unsigned)</i>	<i>Default</i>		
0: Disabled			
120V / 230V: 0.0–390.0 VDC	380.0		
460V: 0.0–900.0 VDC	760.0		
575V: 0.0–1000.0 VDC	975.0		

Set P06.01 to 0.0 to disable the over-voltage stall prevention function (connected with braking unit or braking resistor). Use this setting when braking units or braking resistors are connected to the drive.

Set P06.01 to a value > 0.0 to enable the over-voltage stall prevention. This setting refers to the power supply system and loading. If the setting is too low, then over-voltage stall prevention is easily activated, which may increase deceleration time.

Related parameters:

P01.13, P01.15, P01.17, P01.19 Deceleration Time 1–4, P02.13 Multi-function Output 1 (R1), P02.16–P02.17 Multi-function Output (DO1, DO2), and P06.02 Selection for Over-voltage Stall Prevention.

P06.02 Selection for Over-voltage Stall Prevention

Range/Units (Format: 16-bit binary)

- 0: Traditional over-voltage stall prevention
- 1: Smart over-voltage stall prevention

Type	Hex Addr	Dec Addr
◆R/W	0602	41539
Default		0

Use this function when you are unsure about the load inertia. When stopping under normal load, the over-voltage does not occur during deceleration and meet the deceleration time setting.

If an over-voltage occurs during deceleration to STOP due to a regenerative inertial load increase, then the AC motor drive extends the deceleration time automatically until the drive stops.

When P06.02 is set to 0, and during deceleration the motor exceeds the synchronous speed due to high load inertia (the motor becomes an electrical generator), then the DC bus voltage may exceed its maximum allowable value due to motor regeneration, or drive deceleration time being set too short. When traditional over-voltage stall prevention is enabled, if the DC bus voltage detected is too high, then the drive stops deceleration until the DC bus voltage drops below the setting value.

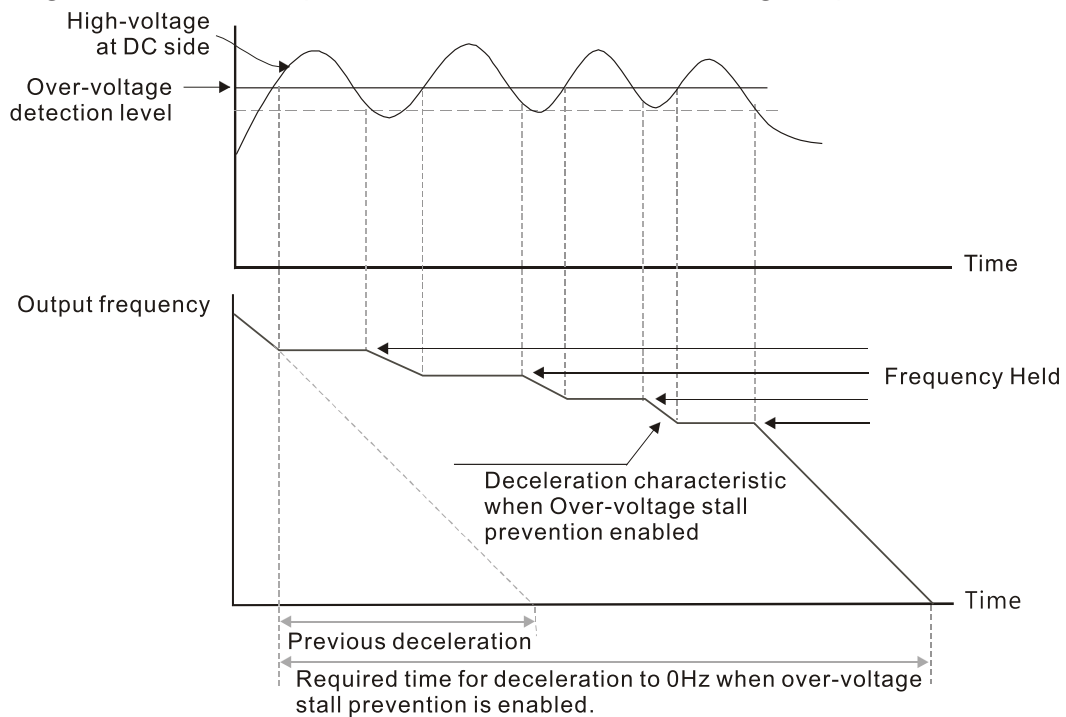

When P06.02 is set to 1 (smart over-voltage stall prevention), during deceleration the drive maintains the DC bus voltage preventing drive OV.

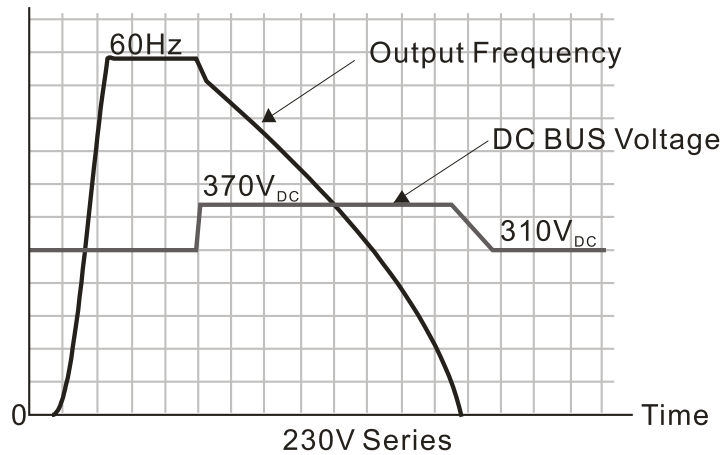

When you enable the over-voltage stall prevention, the drive’s deceleration time is longer than the setting. If you encounter any problem with the deceleration time, refer to the following guides for troubleshooting.

- 1) Increase the deceleration time to a proper value.
- 2) Install a braking resistor (refer to Accessories appendix for details) to dissipate the electrical energy that is generated from the motor.

Related parameters:

P01.13, P01.15, P01.17, P01.19 Deceleration Time 1–4, P02.13 Multi-function Output 1 (Relay 1), P02.16–P02.17 Multi-function Output (DO1, DO2), and P06.01 Over-voltage Stall Prevention.

	Type	Hex Addr	Dec Addr
P06.03 Over-current Stall Prevention during Acceleration	◆R/W	0603	41540
<i>Range/Units (Format: 16-bit unsigned)</i>	<i>Default</i>		
Variable Torque (VT): 0–150% (100% corresponds to the rated current of the drive)	120		
Constant Torque (CT): 0–200% (100% corresponds to the rated current of the drive)	180		

In constant torque mode (P00.16=1), if the DC voltage is higher than the 875VDC (575V series), 700VDC (460V series) or 350VDC (120/230 series), the maximum value for P06.03 is 185%.

- If the motor load is too large or the drive’s acceleration time is too short, the output current of the drive may be too high during acceleration, and it may cause motor damage or trigger the drive’s protection functions (OL or OC). Use this parameter to prevent these situations.
- During acceleration, the output current of the drive may increase abruptly and exceed the setting value of P06.03. In this case, the drive stops accelerating and keeps the output frequency constant, and then continues to accelerate until the output current decreases.
- When you enable the over-current stall prevention, the drive’s acceleration time is longer than the setting.
- When the over-current stall prevention occurs because the motor capacity is too small or operates in the default, decrease the P06.03 setting value.
- If you encounter any problem with the acceleration time, refer to the following guides for troubleshooting.
 - a) Increase the deceleration time to a proper value.
 - b) Set P01.44 Auto-Acceleration and Auto-Deceleration Setting to 1, 3 or 4 (auto-acceleration)

Related parameters:

P01.12, P01.14, P01.16, P01.18 (Acceleration Time 1–4), P01.44. Auto-Acceleration and Auto-Deceleration Setting, P02.13 Multi-function Output 1 (Relay 1), P02.16–P02.17 Multi-function Output (DO1, DO2).

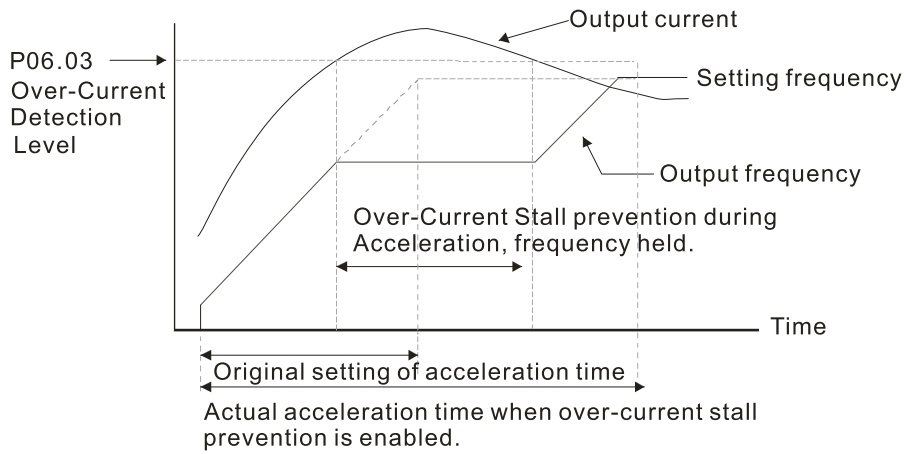

P06.04 Over-current Stall Prevention during Operation

Range/Units (Format: 16-bit unsigned)

Variable Torque (VT): 0–150%
 (100% corresponds to the rated current of the drive)
 Constant Torque (CT): 0–200%
 (100% corresponds to the rated current of the drive)

Type	Hex Addr	Dec Addr
◆R/W	0604	41541
<u>Default</u>		
	120 / 180	

In constant torque mode (P00.16=1), if the DC voltage is higher than the 875VDC (575V series), 700VDC (460V series) or 350VDC (120/230 series), the maximum value for P06.04 is 185%.

- This is a protection for the drive and decreases output frequency automatically when the motor overloads abruptly during constant motor operation.
- If the output current exceeds the setting value for P06.04 when the drive is operating, the drive decelerates according to the P06.05 setting to prevent the motor from stalling. If the output current is lower than the setting value for P06.04, the drive accelerates (according to P06.05) to the setting frequency.

P06.04

Over-current stall prevention level during operation

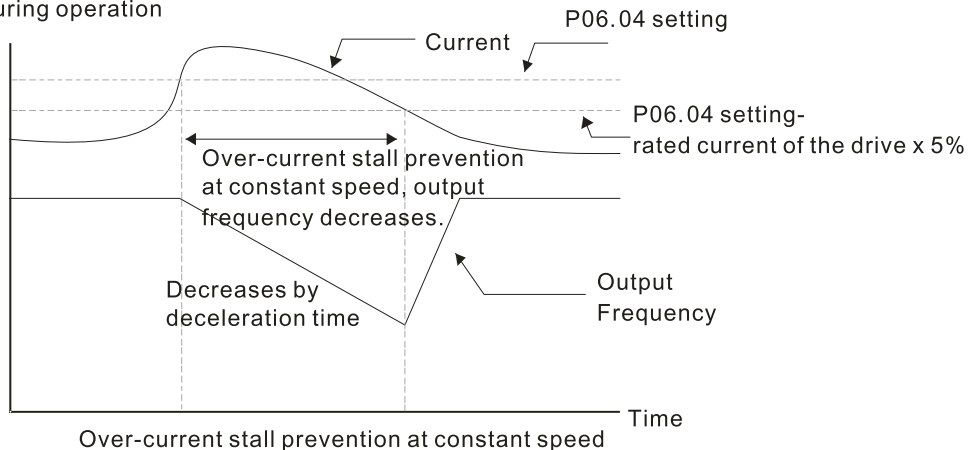

	<i>Type</i>	<i>Hex Addr</i>	<i>Dec Addr</i>
P06.05 Acceleration/Deceleration Time Selection for Stall Prevention at Constant Speed	◆R/W	0605	41542
<i>Range/Units (Format: 16-bit binary)</i>	<i>Default</i>		
0: By current acceleration / deceleration time	0		
1: By the first acceleration / deceleration time			
2: By the second acceleration / deceleration time			
3: By the third acceleration / deceleration time			
4: By the fourth acceleration / deceleration time			
5: By auto-acceleration / auto-deceleration			

P06.05 sets the acceleration / deceleration time selection when stall prevention occurs at constant speed.

	<i>Type</i>	<i>Hex Addr</i>	<i>Dec Addr</i>
P06.06 Over-torque Detection Selection (Motor 1)	◆R/W	0606	41543
P06.09 Over-torque Detection Selection (Motor 2)	◆R/W	0609	41546
<i>Range/Units (Format: 16-bit binary)</i>	<i>Default</i>		
0: No function	0		
1: Continue operation after over-torque detection during constant speed operation			
2: Stop after over-torque detection during constant speed operation			
3: Continue operation after over-torque detection during RUN			
4: Stop after over-torque detection during RUN			

When you set P06.06 and P06.09 to 1 or 3, a warning message displays but there is no error record. When you set P06.06 and P06.09 to 2 or 4, an error message displays and there is an error record.

	<i>Type</i>	<i>Hex Addr</i>	<i>Dec Addr</i>
P06.07 Over-torque Detection Level (Motor 1)	◆R/W	0607	41544
P06.10 Over-torque Detection Level (Motor 2)	◆R/W	060A	41547
<i>Range/Units (Format: 16-bit unsigned)</i>	<i>Default</i>		
10–250% (100% corresponds to the rated current of the drive)	120		

	<i>Type</i>	<i>Hex Addr</i>	<i>Dec Addr</i>
P06.08 Over-torque Detection Time (Motor 1)	◆R/W	0608	41545
P06.11 Over-torque Detection Time (Motor 2)	◆R/W	060B	41548
<i>Range/Units (Format: 16-bit unsigned)</i>	<i>Default</i>		
0.1–60.0 sec.	0.1		

When the output current exceeds the over-torque detection level (P06.07 or P06.10) and also exceeds the over-torque detection time (P06.08 or P06.11), the over-torque detection follows the setting of P06.06 and P06.09.

- When you set P06.06 or P06.09 to 1 or 3, an ot1 / ot2 warning displays while the drive keeps running after over-torque detection. The warning remains on until the output current is smaller than 5% of the over-torque detection level.

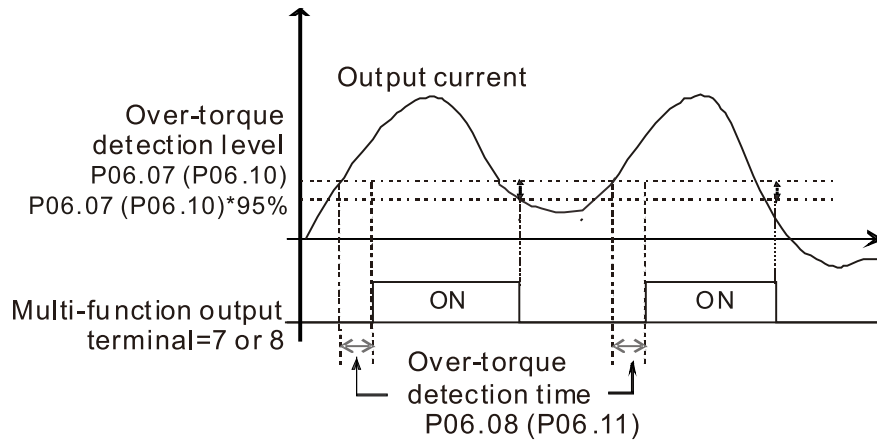

- When you set P06.06 or P06.09 to 2 or 4, an ot1 / ot2 warning displays and the drive stops running after over-torque detection. The drive does not run until you manually reset it.

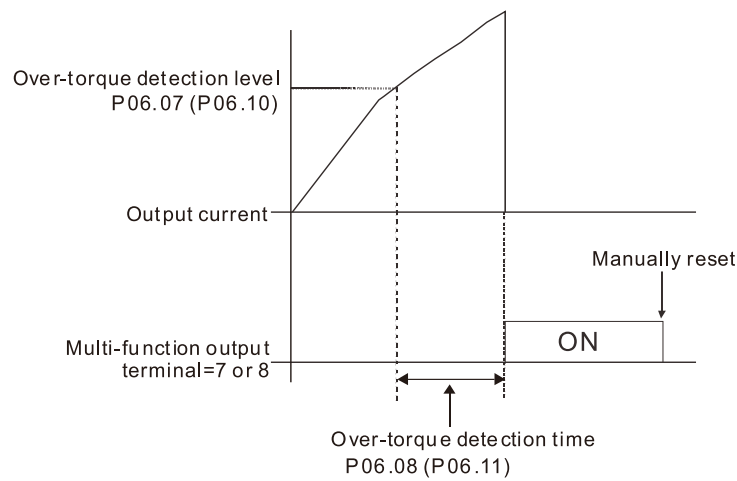

P06.12 Current Limit

Range/Units (Format: 16-bit unsigned)

0–250% (100% corresponds to the rated current of the drive)

This parameter limits the current output of the drive in all control modes.

Type	Hex Addr	Dec Addr
◆R/W	060C	41549
<i>Default</i>		
	150	

P06.13 Electronic Thermal Relay Selection 1 (Motor 1)

P06.27 Electronic Thermal Relay Selection 2 (Motor 2)

Range/Units (Format: 16-bit binary)

- 0: Inverter motor (with external forced cooling)
- 1: Standard motor (motor with fan on the shaft)
- 2: Disable

These parameters prevent self-cooled motors from overheating under low speed. Use an electronic thermal relay to limit the drive’s output power. A value of 1 or 2 is recommended for most applications to better protect the motor.

- Setting the parameter to 0 is suitable for an inverter motor (motor fan using an independent power supply). For this kind of motor, there is no significant correlation between cooling capacity and motor speed. Therefore, the action of electronic thermal relays remains stable in low speed to ensure the load capability of the motor in low speed.

Type	Hex Addr	Dec Addr
◆R/W	060D	41550
◆R/W	061B	41564
<i>Default</i>		
	1	

- Setting the parameter to 1 is suitable for standard motor (motor fan is fixed on the rotor shaft). For this kind of motor, the cooling capacity is lower in low speed; therefore, the action of an electronic thermal relay reduces the action time to ensure the life of motor.
- When the power is cycled frequently, the electronic thermal relay protection is reset when the power is switched OFF; therefore, even setting the parameter to 0 or 1 may not protect the motor well. If there are several motors connected to one drive, install an electronic thermal relay in each motor.

	Type	Hex Addr	Dec Addr
P06.14 Electronic Thermal Relay Action Time 1 (Motor 1)	◆R/W	060E	41551
P06.28 Electronic Thermal Relay Action Time 2 (Motor 2)	◆R/W	061C	41565
<u>Range/Units (Format: 16-bit unsigned)</u>	<u>Default</u>		
30.0–600.0 sec.	60.0		

The electronic thermal relay amperage threshold is based on 150% of the parameter value in “Full Load Current for Induction Motor X” (P5.01 for motor 1, P5.13 for motor 2).

Set Parameter 06.14 or 06.28 for the amount of time the motor exceeds this threshold. Proper setup will prevent motor damage due to overheating. When it reaches the setting, the drive displays “EoL3 / EoL4”, and the motor coasts to stop.

Use this parameter to set the action time of the electronic thermal relay. It works based on the I2t characteristic curve of electronic thermal relay, the output frequency and current of the drive, and the operation time to prevent the motor from overheating.

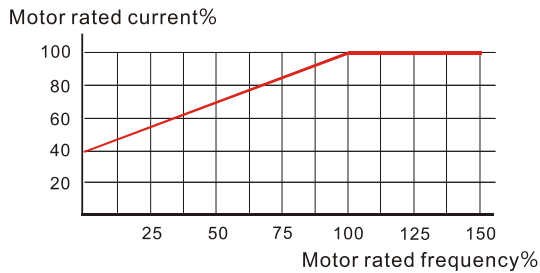

Motor cooling curve with shaft-fixed fan

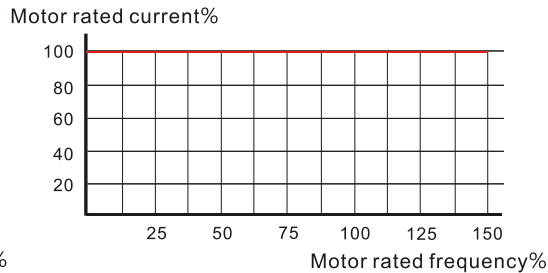

Motor cooling curve with independent fan

The action of the electronic thermal relay depends on the settings for P06.13 and P06.27.

- 1) P06.13 or P06.27 is set to 0 (using inverter motor):
When the output current of the drive is higher than 150% of the motor rated current (refer to the motor rated current % corresponded to the motor rated frequency in the motor cooling curve with independent fan), the drive starts to count the time. The electronic thermal relay acts when the accumulated time exceeds P06.14 or P06.28.

- 2) P06.13 or P06.27 is set to 1 (using standard motor):
 When the output current of the drive is higher than 150% of the motor rated current (refer to the motor rated current % corresponded to the motor rated frequency in the motor cooling curve with shaft-fixed fan), the drive starts to count the time. The electronic thermal relay acts when the accumulated time exceeds P06.14 or P06.28.
 The actual electronic thermal relay action time adjusts according to the drive output current (shown as the motor loading rate %). The action time is short when the current is high, and the action time is long when the current is low. Refer to the following diagram.

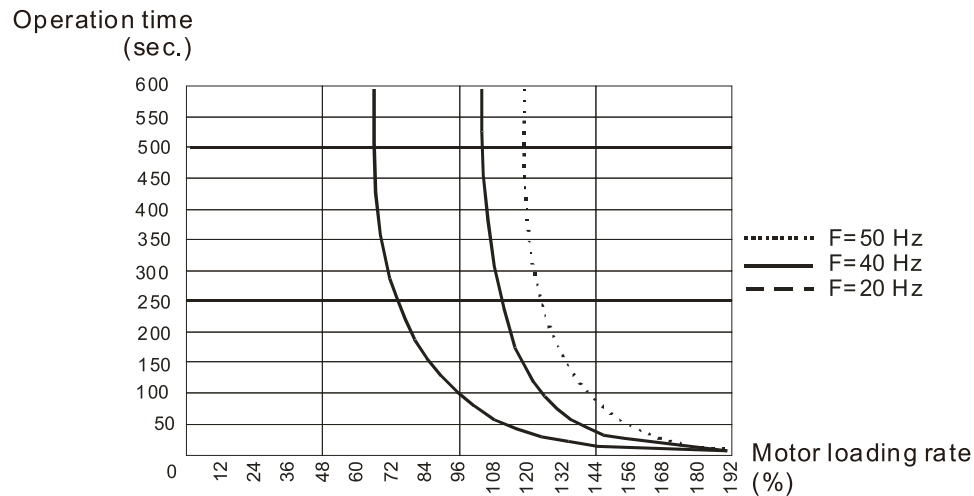

	Type	Hex Addr	Dec Addr
P06.15 Temperature Level Overheat (OH) Warning	◆R/W	060F	41552
<i>Range/Units (Format: 16-bit unsigned)</i>	<i>Default</i>		
0.0–110.0°C	Model dependent		

P06.15 sets the drive’s internal IGBT overheat warning level. When the temperature is higher than P06.15 setting, the oH1 fault displays and the warning remains but it does not affect the drive operation.

- Use this parameter to check the IGBT temperature in order to take precautionary measures to decrease the temperature and maintain the IGBT’s normal operation.
- When the IGBT temperature reaches 5°C higher than the maximum setting value for P06.15, IGBT overheating occurs and the drive stops. Refer to oH1 fault descriptions for details.

	Type	Hex Addr	Dec Addr
P06.16 Stall Prevention Limit Level (Weak Magnetic Field Current Stall Prevention Level)	◆R/W	0610	41553
<i>Range/Units (Format: 16-bit unsigned)</i>	<i>Default</i>		
0–100% (Refer to P06.03–P06.04)	100		

P06.16 only works in VF, VFPG, and SVC control mode.

Sets the over-current stall prevention level when the motor’s operation frequency is larger than P01.01 (base frequency).

Example:

When P06.03 = 150%, P06.04 = 100% and P06.16 = 80%.

- The over-current stall prevention level during acceleration:
 $P06.03 * P06.16 = 150 * 80\% = 120\%$
- The over-current stall prevention level during operation:
 $P06.04 * P06.16 = 100 * 80\% = 80\%$

	<i>Type</i>	<i>Hex Addr</i>	<i>Dec Addr</i>
<u>P06.17</u> <i>Fault Record 1</i>	Read	0611	41554
<u>P06.18</u> <i>Fault Record 2</i>	Read	0612	41555
<u>P06.19</u> <i>Fault Record 3</i>	Read	0613	41556
<u>P06.20</u> <i>Fault Record 4</i>	Read	0614	41557
<u>P06.21</u> <i>Fault Record 5</i>	Read	0615	41558
<u>P06.22</u> <i>Fault Record 6</i>	Read	0616	41559
<i>Range/Units (Format: 16-bit binary)</i>	<i>Default</i>		
0: No fault record	0		
1: Over-current during acceleration (ocA)			
2: Over-current during deceleration (ocd)			
3: Over-current during steady operation (ocn)			
4: Ground fault (GFF)			
6: Over-current at stop (ocS)			
7: Over-voltage during acceleration (ovA)			
8: Over-voltage during deceleration (ovd)			
9: Over-voltage during constant speed (ovn)			
10: Over-voltage at stop (ovS)			
11: Low-voltage during acceleration (LvA)			
12: Low-voltage during deceleration (Lvd)			
13: Low-voltage during constant speed (Lvn)			
14: Low-voltage at stop (LvS)			
15: Phase loss protection (orP)			
16: IGBT overheating (oH1)			
18: IGBT temperature detection failure (tH1o)			
21: Over load (oL)			
22: Electronic thermal relay 1 protection (EoL1)			
23: Electronic thermal relay 2 protection (EoL2)			
24: Motor PTC overheating (oH3)			
26: Over torque 1 (ot1)			
27: Over torque 2 (ot2)			
28: Under current (uC)			
31: EEPROM read error (cF2)			
33: U-phase error (cd1)			
34: V-phase error (cd2)			
35: W-phase error (cd3)			
36: cc (current clamp) hardware error (Hd0)			
37: oc (over-current) hardware error (Hd1)			
40: Auto-tuning error (AUE)			
41: PID loss AI2 (AFE)			
43: PG feedback loss (PGF2)			
44: PG feedback stall (PGF3)			
45: PG slip error (PGF4)			
48: AI2 loss (ACE)			
49: External fault (EF)			
50: Emergency stop (EF1)			
51: External base block (bb)			
52: Password is locked (Pcod)			
54: Illegal command (CE1)			
55: Illegal data address (CE2)			
56: Illegal data value (CE3)			
57: Data is written to read-only address (CE4)			

58: Modbus transmission time-out (CE10)
61: Y-connection / Δ -connection switch error (ydc)
62: Deceleration energy backup error (dEb)
63: Over slip error (oSL)
72: STO Loss (STL1)
76: STO (STo)
77: STO Loss 2 (STL2)
78: STO Loss 3 (STL3)
79: U-phase over-current before run (Aoc)
80: V-phase over-current before run (boc)
81: W-phase over-current before run (coc)
82: Output phase loss U phase (oPL1)
83: Output phase loss V phase (oPL2)
84: Output phase loss W phase (oPL3)
87: Low frequency overload protection (oL3)
89: Rotor position detection error (roPd)
97: Ethernet Card Timeout (CD10)
111: InrCOM time-out error (ictE)
121: Internal communication error (CP20)
123: Internal communication error (CP22)
124: Internal communication error (CP30)
126: Internal communication error (CP32)
127: Internal communication error (CP33)
128: Over-torque 3 (ot3)
129: Over-torque 4 (ot4)
134: Internal communication error (EoL3)
135: Internal communication error (EoL4)
140: Oc hardware error (Hd6)
141: GFF occurs before run (b4GFF)
142: Auto-tune error 1 (DC test stage) (AuE1)
143: Auto-tune error 2 (High frequency test stage) (AuE2)
144: Auto-tune error 3 (Rotary test stage) (AuE3)
149: Auto-tune error 5 (Rotor resistance measure test stage) (AuE5)

These parameters record when the fault occurs and forces a stop.

- When low-voltage at stop fault (LvS) occurs, the fault is not recorded. When low-voltage during operation faults (LvA, Lvd, Lvn) occur, the faults are recorded.
- When dEb function is valid and enabled, the drive executes dEb and records fault code 62 to P06.17–P06.22 and P14.70–P14.73 simultaneously.

	Type	Hex Addr	Dec Addr
P06.23 <i>Fault Output Option 1</i>	◆R/W	0617	41560
P06.24 <i>Fault Output Option 2</i>	◆R/W	0618	41561
P06.25 <i>Fault Output Option 3</i>	◆R/W	0619	41562
P06.26 <i>Fault Output Option 4</i>	◆R/W	061A	41563
<i>Range/Units (Format: 16-bit unsigned)</i>	<i>Default</i>		
0–65535 (refer to bit table for fault code)	0		

Use these parameters with multi-function output terminal (set P06.23–P06.26 to 35–38) for the specific requirement. When a fault occurs, the corresponding terminals are activated. Convert the binary value to a decimal value before you enter the value for P06.23–P06.26.

Fault Code Table

Fault Code	bit 0	bit 1	bit 2	bit 3	bit 4	bit 5	bit 6
	current	Volt.	OL	SYS	FBK	EXI	CE
0: No fault record							
1: Over-current during acceleration (ocA)	•						
2: Over-current during deceleration (ocd)	•						
3: Over-current during steady operation (ocn)	•						
4: Ground fault (GFF)	•						
6: Over-current at stop (ocS)	•						
7: Over-voltage during acceleration (ovA)		•					
8: Over-voltage during deceleration (ovd)		•					
9: Over-voltage during constant speed (ovn)		•					
10: Over-voltage at stop (ovS)		•					
11: Low-voltage during acceleration (LvA)		•					
12: Low-voltage during deceleration (Lvd)		•					
13: Low-voltage during constant speed (Lvn)		•					
14: Low-voltage at stop (LvS)		•					
15: Phase loss protection (orP)		•					
16: IGBT over-heat (oH1)			•				
18: IGBT temperature detection failure (tH1o)			•				
21: Drive over-load (oL)			•				
22: Electronics thermal relay 1 protection (EoL1)			•				
23: Electronics thermal relay 2 protection (EoL2)			•				
24: Motor PTC overheating (oH3)			•				
26: Over torque 1 (ot1)			•				
27: Over torque 2 (ot2)			•				
28: Under current (uC)	•						
31: EEPROM read error (cF2)				•			
33: U-phase error (cd1)				•			
34: V-phase error (cd2)				•			
35: W-phase error (cd3)				•			
36: cc (current clamp) hardware error (Hd0)				•			
37: oc (over-current) hardware error (Hd1)				•			
40: Auto-tuning error (AUE)				•			
41: PID loss ACI (AFE)					•		
43: PG feedback loss (PGF2)					•		
44: PG feedback stall (PGF3)					•		
45: PG slip error (PGF4)					•		

Fault Code	bit 0	bit 1	bit 2	bit 3	bit 4	bit 5	bit 6
	current	Volt.	OL	SYS	FBK	EXI	CE
48: ACI loss (ACE)					•		
49: External fault (EF)						•	
50: Emergency stop (EF1)						•	
51: External base block (bb)						•	
52: Password is locked (Pcod)				•			
54: Illegal command (CE1)							•
55: Illegal data address (CE2)							•
56: Illegal data value (CE3)							•
57: Data is written to read-only address (CE4)							•
58: Modbus transmission time-out (CE10)							•
61: Y-connection / Δ-connection switch error (ydc)						•	
62: Deceleration energy backup error (dEb)		•					
63: Over slip error (oSL)						•	
72: STO Loss (STL1)				•			
76: STO (STo)				•			
77: STO Loss 2 (STL2)				•			
78: STO Loss 3 (STL3)				•			
79: U-phase over-current before run (Aoc)	•						
80: V-phase over-current before run (boc)	•						
81: W-phase over-current before run (coc)	•						
82: U-phase output phase loss (oPL1)	•						
83: V-phase output phase loss (oPL2)	•						
84: W-phase output phase loss (oPL3)	•						
87: Low frequency overload protection (oL3)			•				
89: Rotor position detection error (roPd)					•		
97: Ethercat Card Timeout (CD10)							•
111: InrCOM time-out error (ictE)							•
121: Internal communication error (CP20)							•
123: Internal communication error (CP22)							•
124: Internal communication error (CP30)							•
126: Internal communication error (CP32)							•
127: Internal communication error (CP33)				•			
128: Over-torque 3 (ot3)			•				
129: Over-torque 4 (ot4)			•				
134: Electronics thermal relay 3 protection (EoL3)			•				
135: Electronics thermal relay 4 protection (EoL4)			•				
140: Oc hardware error (Hd6)				•			
141: GFF occurs before run (b4GFF)				•			
142: Auto-tuning error 1 (no feedback current error) (AUE1)				•			
143: Auto-tuning error 2 (motor phase loss error) (AUE2)				•			
144: Auto-tuning error 3 (no-load current I0 measuring error) (AUE3)				•			
149: Auto-tune error 5 (Rotor resistance measuring error) (AUE5)				•			

		Type	Hex Addr	Dec Addr
P06.29	PTC Detection Selection	◆R/W	061D	41566
<i>Range/Units (Format: 16-bit binary)</i>		<i>Default</i>		
0: Warn and continue operation		0		
1: Fault and ramp to stop				
2: Fault and coast to stop				
3: No warning				

P06.29 sets the operation mode of a drive after detecting PTC (Positive Temperature Coefficient).

		Type	Hex Addr	Dec Addr
P06.30	PTC Level	◆R/W	061E	41567
<i>Range/Units (Format: 16-bit binary)</i>		<i>Default</i>		
0.0–100.0%		50.0		

P06.30 sets AI1 / AI2 analog input function P03.00–03.01 to 6 [thermistor (PTC) input value].

- Use this parameter to set the PTC level; 100% PTC level corresponds to the maximum analog input value.
- When using the AI1 terminal, you must set P03.28 to 0 and switch AI2 voltage to 0–10 V. At this time, the AI1 input impedance is 20 KΩ.
- When the temperature rises to the set protection level, the motor responds according to the settings for P06.29 and displays warning "oH3" (if P06.29 = 1–3). When the temperature is lower than the set protection level, you can press RESET key to clear the fault.
- The PTC uses the AI1-input and is connected through divider resistance as shown below:
 - a) The voltage between +10V to ACM: lies within 10–11V.
 - b) The impedance for AI1 is around 20K Ω. Recommended value for divider resistance is 1K–10K Ω.
 - c) Please contact your motor dealer for the curve of temperature and resistance value for PTC.

$$\text{Protection level (P06.30)} = V+10 * (R_{PTC} // 20K) / [R1 + (R_{PTC} // 20K)]$$
 - i) V+10: voltage between +10V-ACM actual value
 - ii) RPTC: motor PTC overheat protection level;
 - iii) 20K Ω: the AI1 input impedance;
 - iv) R1: divider resistance (recommended value: 1–10k Ω)

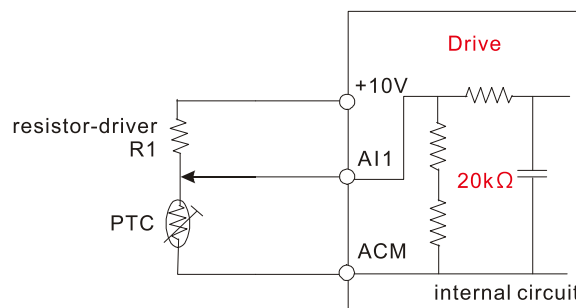

Take the standard PTC thermistor as an example: if the protection level is 1330 Ω, the actual voltage between +10V-ACM is 10.5 V and divider resistance R1 is 4.4k Ω.

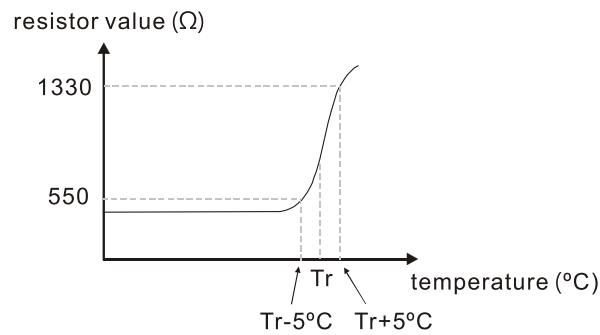

Refer to the following calculation when P06.30 is set to 23% and motor temperature overheating protection level is 1330Ω:

$$1330//20000 = (1330*20000) / (1330+20000) = 1247.07$$

$$10.5 * 1247.07 / (4400+1247.07) = 2.32 \text{ (V)} = 2.3 \text{ (V)}$$

$$P06.30 = 2.3 / 10 \text{ V} * \% = 23\%$$

	Type	Hex Addr	Dec Addr
P06.31 Frequency Command at Malfunction	Read	061F	41568
<i>Range/Units (Format: 16-bit unsigned)</i>	<i>Default</i>		
0.00–599.00 Hz	0		

When a malfunction occurs, check the current Frequency command. If it happens again, it overwrites the previous record

	Type	Hex Addr	Dec Addr
P06.32 Output Frequency at Malfunction	Read	0620	41569
<i>Range/Units (Format: 16-bit unsigned)</i>	<i>Default</i>		
0.00–599.00 Hz	0		

When a malfunction occurs, check the current output frequency. If it happens again, it overwrites the previous record.

	Type	Hex Addr	Dec Addr
P06.33 Output Voltage at Malfunction	Read	0621	41570
<i>Range/Units (Format: 16-bit unsigned)</i>	<i>Default</i>		
0.0–6553.5 V	0		

When a malfunction occurs, check the current output voltage. If it happens again, it overwrites the previous record.

	Type	Hex Addr	Dec Addr
P06.34 DC bus Voltage at Malfunction	Read	0622	41571
<i>Range/Units (Format: 16-bit unsigned)</i>	<i>Default</i>		
0.0–6553.5 V	0		

When a malfunction occurs, check the current DC bus voltage. If it happens again, it overwrites the previous record.

	<u>Type</u>	<u>Hex Addr</u>	<u>Dec Addr</u>
P06.35 Output Current at Malfunction	Read	0623	41572
<u>Range/Units (Format: 16-bit unsigned)</u>	<u>Default</u>		
0.00–655.35 Amp	0		

When a malfunction occurs, check the current output current. If it happens again, it overwrites the previous record.

	<u>Type</u>	<u>Hex Addr</u>	<u>Dec Addr</u>
P06.36 IGBT Temperature at Malfunction	Read	0624	41573
<u>Range/Units (Format: 16-bit signed)</u>	<u>Default</u>		
-3276.7–3276.7 °C	0		

When a malfunction occurs, check the current IGBT temperature. If it happens again, it overwrites the previous record.

	<u>Type</u>	<u>Hex Addr</u>	<u>Dec Addr</u>
P06.38 Motor Speed at Malfunction	Read	0626	41575
<u>Range/Units (Format: 16-bit signed)</u>	<u>Default</u>		
-32767–32767 rpm	0		

When a malfunction occurs, check the current motor speed in rpm. If it happens again, it overwrites the previous record.

	<u>Type</u>	<u>Hex Addr</u>	<u>Dec Addr</u>
P06.39 Torque Command at Malfunction	Read	0627	41576
<u>Range/Units (Format: 16-bit signed)</u>	<u>Default</u>		
-32767–32767%	0		

When a malfunction occurs, check the current torque command. If it happens again, it overwrites the previous record.

	<u>Type</u>	<u>Hex Addr</u>	<u>Dec Addr</u>
P06.40 Status of the Multi-function Input Terminal at Malfunction	Read	0628	41577
P06.41 Status of the Multi-function Output Terminal at Malfunction	Read	0629	41578
<u>Range/Units (Format: 16-bit unsigned)</u>	<u>Default</u>		
0000h–FFFFh	0		

When a malfunction occurs, check the current status of the multi-function input/output terminals. If it happens again, it overwrites the previous record.

	<u>Type</u>	<u>Hex Addr</u>	<u>Dec Addr</u>
P06.42 Drive Status at Malfunction	Read	062A	41579
<u>Range/Units (Format: 16-bit unsigned)</u>	<u>Default</u>		
0000h–FFFFh	0		

When a malfunction occurs, check the current drive status (communication address 2101H). If it happens again, it overwrites the previous record.

	Type	Hex Addr	Dec Addr
P06.43 IGBT Temperature	Read	062B	41580
<u>Range/Units (Format: 16-bit unsigned)</u>	<u>Default</u>		
-3276.7–3276.7 °C	–		

Parameter P06.43 allows the user to monitor the IGBT temperature in degrees Celsius. This register is read only.

	Type	Hex Addr	Dec Addr
P06.44 STO Latch Selection	◆R/W	062C	41581
<u>Range/Units (Format: 16-bit binary)</u>	<u>Default</u>		
0: STO Latch	0		
1: STO No Latch			

Use P06.44 to select STO latch.

- P06.44 = 0: STO Alarm Latch. After you clear the cause of the STO Alarm, use a Reset command to clear the STO Alarm.
- P06.44 = 1: STO Alarm no Latch. After you clear the cause of the STO Alarm, the STO Alarm clears automatically.

All of the STL1–STL3 errors are “Alarm Latch” mode (in STL1–STL3 mode, the P06.44 function is not available).

	Type	Hex Addr	Dec Addr
P06.45 Output Phase Loss Detection Action (OPHL)	◆R/W	062D	41582
<u>Range/Units (Format: 16-bit binary)</u>	<u>Default</u>		
0: Warn and continue operation	3		
1: Fault and ramp to stop			
2: Fault and coast to stop			
3: No warning			

The OPHL protection is enabled when P06.45 is not set to 3.

	Type	Hex Addr	Dec Addr
P06.46 Detection Time for Output Phase Loss	◆R/W	062E	41583
<u>Range/Units (Format: 16-bit unsigned)</u>	<u>Default</u>		
0.000–65.535 sec.	0.500		

	Type	Hex Addr	Dec Addr
P06.47 Current Detection Level for Output Phase Loss	◆R/W	062F	41584
<u>Range/Units (Format: 16-bit unsigned)</u>	<u>Default</u>		
0.00–100.00%	1.00		

	Type	Hex Addr	Dec Addr
P06.48 DC Brake Time for Output Phase Loss	◆R/W	0630	41585
<u>Range/Units (Format: 16-bit unsigned)</u>	<u>Default</u>		
0.000–65.535 sec.	0.000		

Setting P06.48 to 0 disables the OPHL detection function before operation.

- **Status 1:**
The drive is in operation
When any phase is less than the P06.47 setting, and exceeds the P06.46 setting time, the drive executes according to the P06.45 setting.

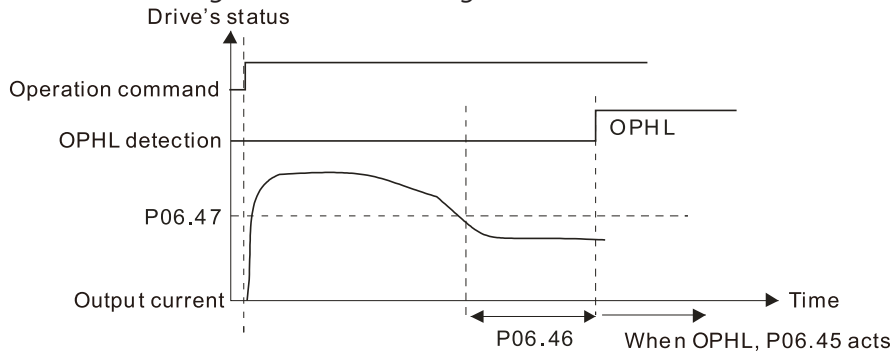

- **Status 2:**
The drive is in STOP; P06.48 = 0; P07.02 ≠ 0
After the drive starts, the DC brake operates according to P07.01 and P07.02. During this period, OPHL detection is not active. After the DC brake action is completed, the drive starts to run, and enables the OPHL protection as mentioned above for status 1.

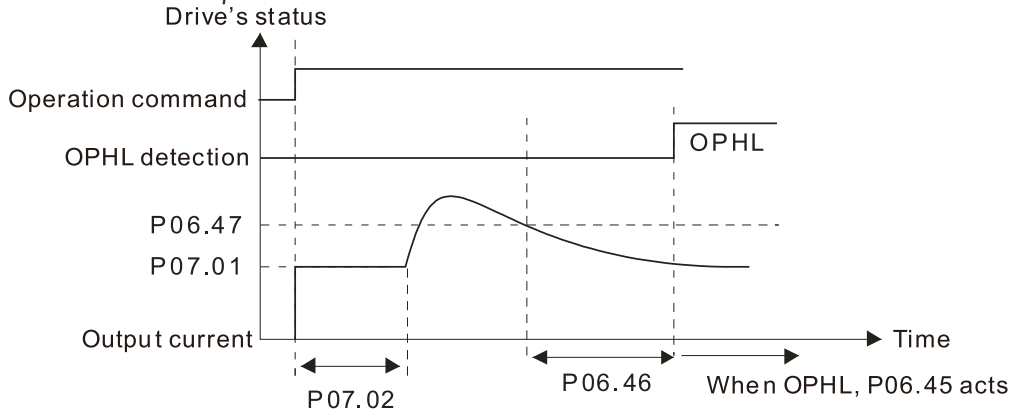

- Status 3:**
 The drive is in STOP; $P06.48 \neq 0$; $P07.02 \neq 0$
 When the drive starts, it executes $P06.48$ first, and then executes $P07.02$ (DC brake). The DC brake current level in this state includes two parts: one is 20 times the $P06.47$ setting value in $P06.48$ setting time; the other is the $P07.01$ setting value in $P07.02$ setting time. The total DC brake time $T = P06.48 + P07.02$. In this period, if an OPHL occurs within the time for $P06.48$, the drive executes the $P06.45$ setting after the drive starts counting for half the time of $P06.48$.

Status 3-1: $P06.48 \neq 0$, $P07.02 \neq 0$ (No OPHL detected before operation)

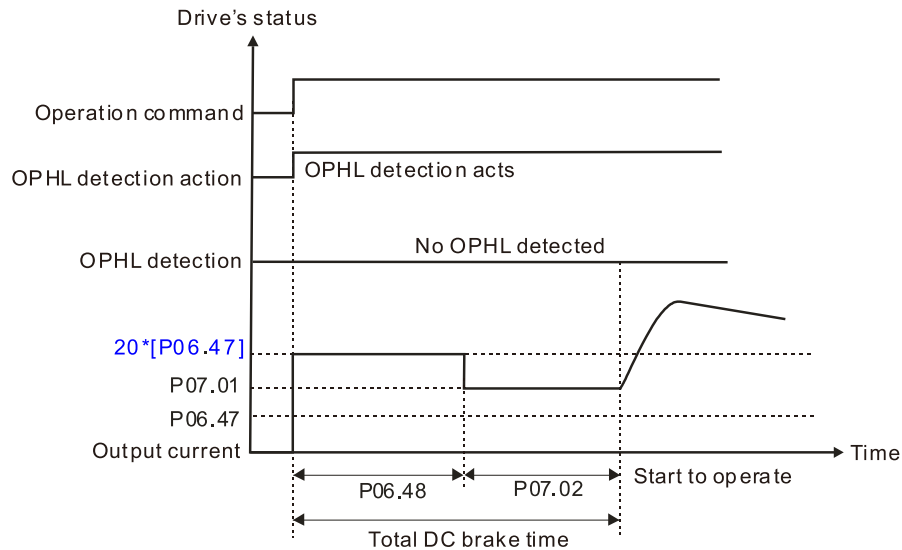

Status 3-2: $P06.48 \neq 0$, $P07.02 \neq 0$ (OPHL detected before operation)

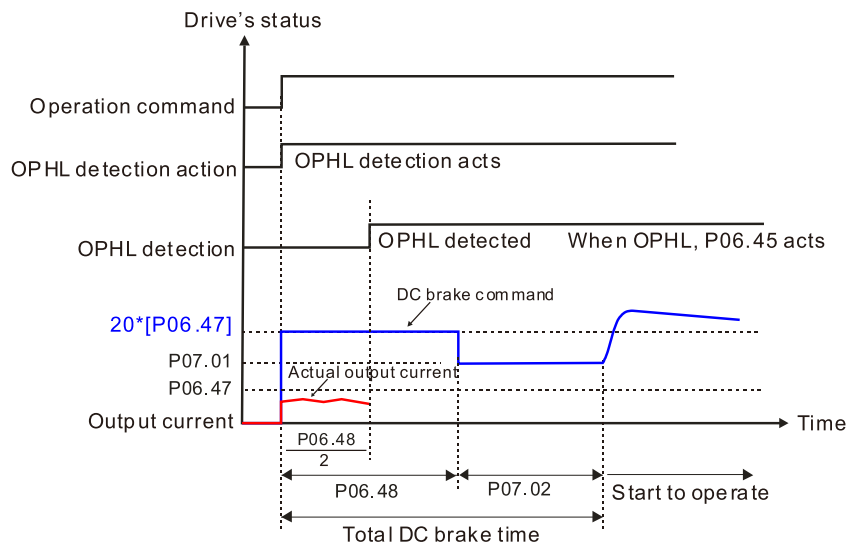

- Status 4:**
 The drive is in STOP; P06.48 ≠ 0; P07.02=0
 When the drive starts, it executes P06.48 as the DC brake. The DC brake current level is 20 times the P06.47 setting value. In this period, if an OPHL occurs within the time for P06.48, the drive executes the P06.45 setting after the drive starts counting for half the time of P06.48.

Status 4-1: P06.48≠0, P07.02=0 (No OPHL detected before operation)

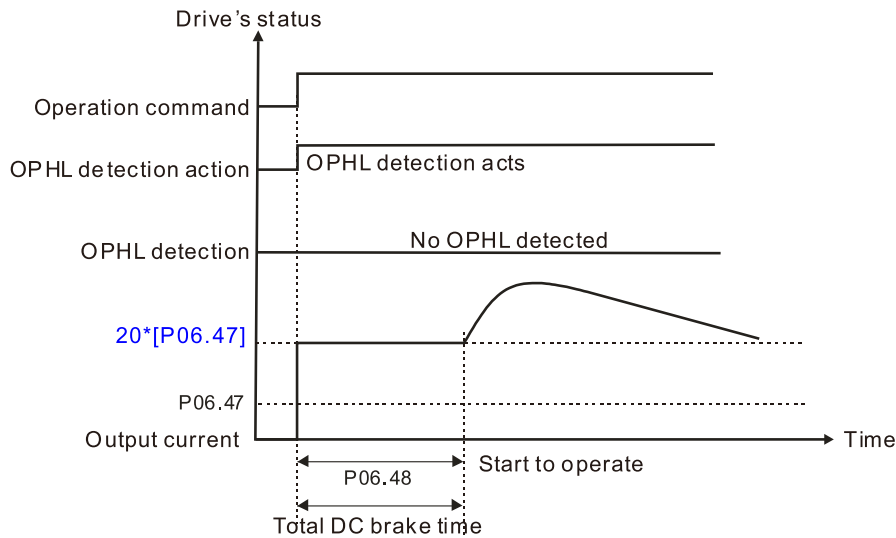

Status 4-2: P06.48≠0, P07.02=0 (OPHL detected before operation)

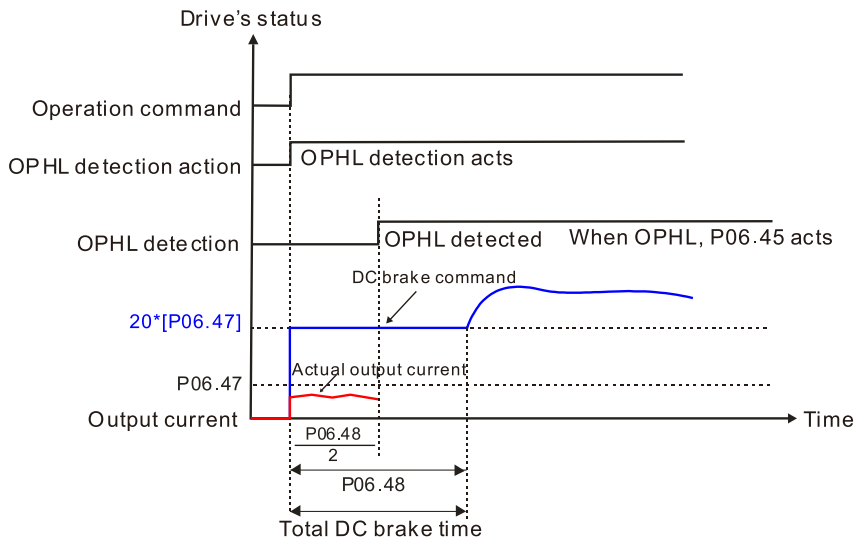

	Type	Hex Addr	Dec Addr
P06.49 LvX Auto-reset	R/W	0631	41586
<i>Range/Units (Format: 16-bit binary)</i>	<i>Default</i>		
0: Disable	0		
1: Enable			

In the event of any low voltage fault on the DC bus (LvS, LvN, LvA, LvD faults), this parameter will automatically reset the drive if enabled.

	Type	Hex Addr	Dec Addr
P06.53 Input Phase Loss Detection Action (OrP)	◆R/W	0635	41590
<u>Range/Units (Format: 16-bit binary)</u>	<u>Default</u>		
0: Fault and ramp to stop	0		
1: Fault and coast to stop			

The drive executes the input phase loss protection according to P06.53.

	Type	Hex Addr	Dec Addr
P06.55 Derating Protection	◆R/W	0637	41592
<u>Range/Units (Format: 16-bit binary)</u>	<u>Default</u>		
0: Constant rated current and limit carrier frequency by load current and temperature	0		
1: Constant carrier frequency and limit load current by setting carrier frequency			
2: Constant rated current (same as setting 0), but close current limit			

Allowable maximum output frequency and the minimum carrier frequency limit in control mode:

For VF, SVC, VFPG modes:

When the maximum output frequency is 599 Hz, the minimum carrier frequency is 6k.

Setting 0:

- When the operating point is greater than the derating curve (when the operating carrier frequency is greater than the rated carrier frequency), the rated current is constant, and carrier frequency (Fc) output by the drive decreases automatically according to the ambient temperature, overload output current and overload time. If overloads are not frequent, and the concern is only about the carrier frequency operating with the rated current for a long time, and changes to the carrier frequency due to short overload are acceptable, set to 0.
- Refer to Derating for Ambient Temperature, Altitude and Carrier Frequency for the carrier frequency derating level.
- Take GS23-45P0 in normal load as an example: ambient temperature 50°C, UL open-type, and independent installation. When the carrier frequency is set to 10kHz, it corresponds to 55% of the rated output current. In the same condition for ambient temperature 40°C, it corresponds to 75% of rated output current. When the output current is higher than this value, it automatically decreases the carrier frequency according to the ambient temperature, output current and overload time. At this time, the overload capacity of the drive is 150% of the rated current.

Setting 1:

- When the operating point exceeds the derating curve 1, the carrier frequency is the setting value. Select this mode if the change of carrier frequency and motor noise caused by ambient temperature and frequent overload are not allowed. (Refer to P00.17.)
- Refer to Derating for Ambient Temperature, Altitude and Carrier Frequency for the rated current derating level. Take GS23-45P0 in variable torque as an example. If you need to maintain the carrier frequency at 10kHz, decrease the rated current to 55%. The OL protection executes when the current is $120\% \times 55\% = 66\%$ for one minute; therefore, you must operate using the values within the derating curve to keep the carrier frequency constant.

Setting 2:

- The protection method and action are the same as setting value 0, but it disables the current limit when output current is the derating ratio $\times 120\%$ (default value) in variable torque and when the output current is the derating ratio $\times 180\%$ (default value) in constant torque. The advantage is that it provides a higher starting output current when the carrier frequency setting is higher than the default. However, the carrier frequency derates easily when it overloads.
Example: when P06.55 = 0 or 1, over-current stall prevention level = Ratio * P06.03. When P06.55 = 2, the over-current stall prevention level = P06.03.

Use this parameter with P00.16 and P00.17.

The ambient temperature also affects the derating. Refer to Derating Curve for Ambient Temperature and Altitude.

Example:

Take GS23-45P0 in variable torque with ambient temperature 50°C, UL open-type, and independent installation. When the carrier frequency is set to 10kHz, it corresponds to 55% of the rated output current. If used for ambient temperature 60°C, it corresponds to 55% * 75% of the rated output current.

P06.56	PT100 RTD Voltage Level 1	<i>Type</i>	<i>Hex Addr</i>	<i>Dec Addr</i>
		◆R/W	0638	41593
		<i>Default</i>	5.000	
	<i>Range/Units (Format: 16-bit unsigned)</i>	0.000–10.000 V		
P06.57	PT100 RTD Voltage Level 2	<i>Type</i>	<i>Hex Addr</i>	<i>Dec Addr</i>
		◆R/W	0639	41594
		<i>Default</i>	7.000	
	<i>Range/Units (Format: 16-bit unsigned)</i>	0.000–10.000 V		

Condition settings: PT100 RTD voltage level P06.57 > P06.56.

P06.58	PT100 RTD Level 1 Frequency Protection	<i>Type</i>	<i>Hex Addr</i>	<i>Dec Addr</i>
		◆R/W	063A	41595
		<i>Default</i>	0.00	
<i>Range/Units (Format: 16-bit unsigned)</i>		0.00–599.00 Hz		

P06.59	PT100 RTD Activation Level 1 Protection Frequency Delay Time	<i>Type</i>	<i>Hex Addr</i>	<i>Dec Addr</i>
		◆R/W	063B	41596
		<i>Default</i>	60	
<i>Range/Units (Format: 16-bit binary)</i>		0–6000 sec.		

PT100 RTD operation instructions:

- 1) Use voltage type analog input (AI1, AI2 voltage 0–10 V) and select PT100 RTD mode.
- 2) Select one of the voltage type analog inputs below:
(a) P03.00 = 11, (b) P03.01 = 11 and P03.29 = 1
- 3) When selecting P03.01 = 11 and P03.29 = 1, you must switch A01 to 0–10 V.
- 4) The A01 outputs constant voltage or current, then P03.20 = 23. You must switch ACM to 0–20 mA, and set A01 output level to 45% (Pr.03-32 = 45%) of 20 mA = 9 mA.
- 5) Use P03.32 to adjust the constant voltage or constant current of the A01 output; the setting range is 0.00–100.00%.
- 6) There are two types of action levels for PT100 RTD. The diagram below shows the PT100 RTD protection action.

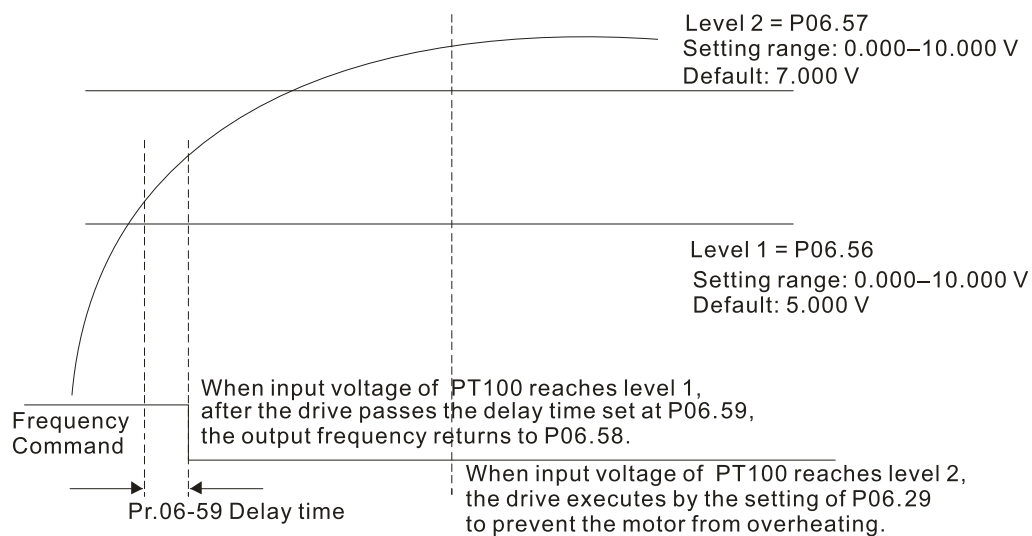

When P06.58 = 0.00 Hz, PT100 RTD function is disabled.

Case:

When using PT100 RTD, if the motor temperature is higher than 135°C (275°F), the drive starts to count the delay time for auto-deceleration (P06.59). The drive decreases the motor frequency to the setting for P06.58 when it reaches the delay time count value. The drive operates at the frequency set for P06.58 until the motor temperature is lower than 135°C (275°F). If the motor temperature is higher than 150°C (302°F), the drive automatically decelerates to STOP and displays the warning “oH3”.

Set up process:

- 1) Switch A01 to 0–20 mA on the control board dip switch.
- 2) Wiring:
Connect external terminal A01 to “+”
Connect external terminal ACM to “-”
Connect A01 and AI1 to “short circuit”

- 3) P03.00 = 11, P03.20 = 23, P03.32 = 45% (9 mA)
- 4) Refer to the PT100 RTD temperature and resistance comparison table
 Temperature = 135°C, resistance = 151.71 Ω, input current: 9 mA, voltage: about 1.37 VDC
 Temperature = 150°C, resistance = 157.33 Ω, input current: 9 mA, voltage: about 1.42 VDC
- 5) When the PT100 RTD temperature > 135°C, the drive decelerates to the specified operation frequency automatically. Then, P06.56 = 1.37 V and P06.58 = 10Hz. (When P06.58 = 0, it disables the specified operation frequency.)
- 6) When PT100 RTD temperature > 150°C, the drive outputs a fault, decelerates to STOP, and displays the warning “oH3”. Then, P06.57 = 1.42 V and P06.29 = 1 (fault and ramp to stop).

	Type	Hex Addr	Dec Addr
P06.60 Software Detection GFF Current Level	◆R/W	063C	41597
<i>Range/Units (Format: 16-bit unsigned)</i>	<i>Default</i>		
0.0–6553.5%	60.0		

	Type	Hex Addr	Dec Addr
P06.61 Software Detection GFF Filter Time	◆R/W	063D	41598
<i>Range/Units (Format: 16-bit unsigned)</i>	<i>Default</i>		
0.00–655.35 sec.	0.10		

When the drive detects that the unbalanced three-phase output current is higher than the setting for P06.60, GFF protection activates. The drive then stops output.

	Type	Hex Addr	Dec Addr
P06.63 Operation Time of Fault Record 1 (Day)	Read	063F	41600
P06.65 Operation Time of Fault Record 2 (Day)	Read	0641	41602
P06.67 Operation Time of Fault Record 3 (Day)	Read	0643	41604
P06.69 Operation Time of Fault Record 4 (Day)	Read	0645	41606
P06.90 Operation Time of Fault Record 5 (Day)	Read	065A	41627
P06.92 Operation Time of Fault Record 6 (Day)	Read	065C	41629
<i>Range/Units (Format: 16-bit unsigned)</i>	<i>Default</i>		
0–65535 days	0		

	Type	Hex Addr	Dec Addr
P06.64 Operation Time of Fault Record 1 (Min.)	Read	0640	41601
P06.66 Operation Time of Fault Record 2 (Min.)	Read	0642	41603
P06.68 Operation Time of Fault Record 3 (Min.)	Read	0644	41605
P06.70 Operation Time of Fault Record 4 (Min.)	Read	0646	41607
P06.91 Operation Time of Fault Record 5 (Min.)	Read	065B	41628
P06.93 Operation Time of Fault Record 6 (Min.)	Read	065D	41630
<i>Range/Units (Format: 16-bit unsigned)</i>	<i>Default</i>		
0–1439 min.			

If there is any malfunction when the drive operates, P06.17–P06.22 records the malfunctions, and P06.63–P06.70 records the operation time for four sequential malfunctions. Check if there is any problem with the drive according to the interval of the recorded fault.

Example:

- The first error: ocA occurs after motor drive operates for 1000 minutes.
- The second error: ocd occurs after another 1000 minutes.
- The third error: ocn occurs after another 1000 minutes.
- The fourth error: ocA occurs after another 1000 minutes.
- The fifth error: ocd occurs after another 1000 minutes.

The sixth error: ocn occurs after another 1000 minutes.
Then, P06.17–P06.22 and P06.63–P06.70 are recorded as follows:

Parameter	1st fault	2nd fault	3rd fault	4th fault	5th fault	6th fault
Pr.06-17	ocA	ocd	ocn	ocA	ocd	ocn
Pr.06-18	0	ocA	ocd	ocn	ocA	ocd
Pr.06-19	0	0	ocA	ocd	ocn	ocA
Pr.06-20	0	0	0	ocA	ocd	ocn
Pr.06-21	0	0	0	0	ocA	ocd
Pr.06-22	0	0	0	0	0	ocA
Pr.06-63	1000	560	120	1120	680	240
Pr.06-64	0	1	2	2	3	4
Pr.06-65	0	1000	560	120	1120	680
Pr.06-66	0	0	1	2	2	3
Pr.06-67	0	0	1000	560	120	1120
Pr.06-68	0	0	0	1	2	2
Pr.06-69	0	0	0	1000	560	120
Pr.06-70	0	0	0	0	1	2

By examining the time record, you can see that the last fault (P06.17) happened after the drive ran for four days and 240 minutes.

P06.71	Low Current Setting Level	<u>Type</u>	<u>Hex Addr</u>	<u>Dec Addr</u>
		◆R/W	0647	41608
	<u>Range/Units (Format: 16-bit unsigned)</u>	<u>Default</u>		
	0.0–100.0%	0.0		
P06.72	Low Current Detection Time	<u>Type</u>	<u>Hex Addr</u>	<u>Dec Addr</u>
		◆R/W	0648	41609
	<u>Range/Units (Format: 16-bit unsigned)</u>	<u>Default</u>		
	0.00–360.00 sec.	0.00		
P06.73	Low Current Action	<u>Type</u>	<u>Hex Addr</u>	<u>Dec Addr</u>
		◆R/W	0649	41610
	<u>Range/Units (Format: 16-bit binary)</u>	<u>Default</u>		
	0 : No function	0		
	1 : Fault and coast to stop			
	2 : Fault and ramp to stop by the second deceleration time			
	3 : Warn and continue operation			

The drive operates according to the setting for P06.73 when the output current is lower than the setting for P06.71 and when the time of the low current exceeds the detection time for P06.72. Use this parameter with the external multi-function output terminal setting 44 (low current output). The low current detection function does not execute when drive is in sleep or standby status.

P06.80	Fire Mode	<i>Type</i>	<i>Hex Addr</i>	<i>Dec Addr</i>
		R/W	0650	41617
	<i>Range/Units (Format: 16-bit binary)</i>	<i>Default</i>		
	0: Disable	0		
	1: Operates in a counterclockwise direction			
	2: Operates in a clockwise direction			

Use this parameter with multi-function input terminal setting 58 or 59, and multi-function output terminal setting 53.

- 0: Fire detection is invalid.
- 1: The motor operates in a counterclockwise direction (U, V, W).
- 2: The motor operates in a clockwise direction (U, W, V).

P06.81	Operating Frequency in Fire Mode	<i>Type</i>	<i>Hex Addr</i>	<i>Dec Addr</i>
		◆R/W	0651	41618
	<i>Range/Units (Format: 16-bit unsigned)</i>	<i>Default</i>		
	0.00–599.00 Hz	60.00		

P06.88	Operation Times in Fire Mode	<i>Type</i>	<i>Hex Addr</i>	<i>Dec Addr</i>
		Read	0658	41625
	<i>Range/Units (Format: 16-bit unsigned)</i>	<i>Default</i>		
	0–65535 times	0		

GROUP P07.XX DETAILS – SPECIAL PARAMETERS

	Type	Hex Addr	Dec Addr
P07.00 Software Brake Chopper Action Level	◆R/W	0000	41793
<i>Range/Units (Format: 16-bit unsigned)</i>	<i>Default</i>		
120V / 230V models: 350.0–450.0 VDC	370.0		
460V models: 700.0–900.0 VDC	740.0		
575V models: 875.0–1000.0 VDC	950.0		

P07.00 sets the DC bus voltage at which the brake chopper is activated. Choose a suitable braking resistor to achieve the optimal deceleration performance. Refer to the Accessories chapter for information about braking resistors.

	Type	Hex Addr	Dec Addr
P07.01 DC Brake Current Level	◆R/W	0701	41794
<i>Range/Units (Format: 16-bit unsigned)</i>	<i>Default</i>		
0–100%	0		

P07.01 sets the level of the DC brake current output to the motor at start-up and stop. When setting the DC brake current, the rated current (P00.01) is 100%. It is recommended that you start with a low DC brake current level and then increase until you reach the proper holding torque. However, the DC brake current cannot exceed the motor’s rated current to prevent the motor from burnout. Therefore, DO NOT use the DC brake for mechanical retention, otherwise injury or accident may occur.

	Type	Hex Addr	Dec Addr
P07.02 DC Brake Time at Start-up	◆R/W	0702	41795
<i>Range/Units (Format: 16-bit unsigned)</i>	<i>Default</i>		
0.0–60.0 sec	0.0		

The motor may continue rotating due to external forces or the inertia of the motor itself. If you use the drive with the motor rotating, it may cause motor damage or trigger drive protection due to over-current. This parameter outputs DC current, generating torque to force the motor stop to get a stable start before motor operation. This parameter determines the duration of the DC brake current output to the motor when the drive starts up. Set this parameter to 0.0 to disable the DC brake at start-up.

	Type	Hex Addr	Dec Addr
P07.03 DC Brake Time at STOP	◆R/W	0703	41796
<i>Range/Units (Format: 16-bit unsigned)</i>	<i>Default</i>		
0.0–60.0 sec	0.0		

The motor may continue rotating after the drive stops output due to external forces or the inertia of the motor itself. This parameter outputs DC current, generating torque to force the motor stop after the drive stops output to make sure that the motor stops.

This parameter determines the duration of the DC Brake current output to the motor when braking. To enable the DC brake at STOP, you must set P00.22 (Stop Method) to 0 (ramp to stop). Set this parameter to 0.0 to disable the DC brake at stop.

Related parameters:

P00.22 Stop Method, P07.04 DC Brake Frequency at Start-up

	Type	Hex Addr	Dec Addr
P07.04 DC Brake Frequency at STOP	◆R/W	0704	41797
<i>Range/Units (Format: 16-bit unsigned)</i>	<i>Default</i>		
0.00–599.00 0 Hz	0.00		

Determines the start frequency of the DC brake before the drive ramps to stop. When this setting is less than P01.09 (Start-up Frequency), the start frequency for the DC brake begins at the minimum frequency.

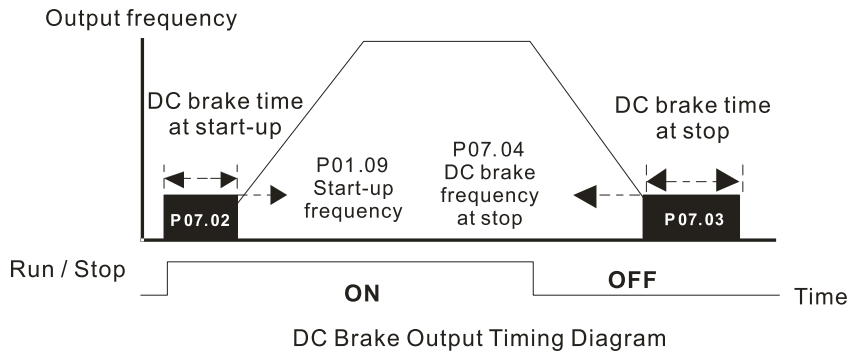

- Use the DC brake before running the motor when the load is movable at stop, such as with fans and pumps. The motor is in free running status and in unknown rotation direction before the drive starts up. Execute the DC brake before you start the motor.
- Use the DC Brake at STOP when you need to brake the motor quickly or to control the positioning, such as with cranes or cutting machines.

	Type	Hex Addr	Dec Addr
P07.05 Voltage Increasing Gain	◆R/W	0705	41798
<i>Range/Units (Format: 16-bit unsigned)</i>	<i>Default</i>		
1–200%	100		

When using speed tracking, adjust P07.05 to slow down the increasing voltage gain if there are errors such as oL or oc; however, the speed tracking time will be longer.

	Type	Hex Addr	Dec Addr
P07.06 Restart after Momentary Power Loss	◆R/W	0706	41799
<i>Range/Units (Format: 16-bit binary)</i>	<i>Default</i>		
0: Stop operation	0		
1: Speed tracking by the speed before the power loss			
2: Speed tracking by the minimum output frequency			

P07.06 determines the operation mode when the drive restarts from a momentary power loss. The power system connected to the drive may power off momentarily for many reasons. This function allows the drive to keep outputting voltages after the drive is repowered and does not cause the drive to stop.

- 1) Frequency tracking begins before momentary power loss and accelerates to the master Frequency command after the drive output frequency and motor rotator speed are synchronous. Use this setting when there is a lot of inertia with little resistance on the motor load. For example, in equipment with a large inertia flywheel, there is NO need to wait until the flywheel stops completely after a restart to execute the operation command; therefore, it saves time.
- 2) Frequency tracking starts from the minimum output frequency and accelerates to the master Frequency command after the drive output frequency and motor rotator speed are synchronous. Use this setting when there is little inertia and large resistance.

In PG control mode, the AC motor drive executes the speed tracking function automatically according to the PG speed when this setting is NOT set to 0.

P07.07	Allowed Power Loss Duration	Type	Hex Addr	Dec Addr
	Range/Units (Format: 16-bit binary)	◆R/W	0707	41800
	0.0–20.0 sec.	Default		2.0

Determines the maximum time of allowable power loss. If the duration of a power loss exceeds this parameter setting, the AC motor drive stops output after the power recovers.

P07.06 is valid when the maximum allowable power loss time is ≤ 20 seconds and the AC motor drive displays “LU”. If the AC motor drive is powered off due to overload, even if the maximum allowable power loss time is ≤ 20 seconds, P07.06 is invalid after the power recovers.

P07.08	Base Block Time	Type	Hex Addr	Dec Addr
	Range/Units (Format: 16-bit binary)	◆R/W	0708	41801
	0.0–60.0 sec.	Default		0.5

When momentary power loss is detected, the AC motor drive blocks its output and then waits for a specified period of time (determined by P07.08, called Base Block Time) before resuming operation. Set this parameter to the time that allows the residual voltage at the output side to decrease to 0V before activating the drive again.

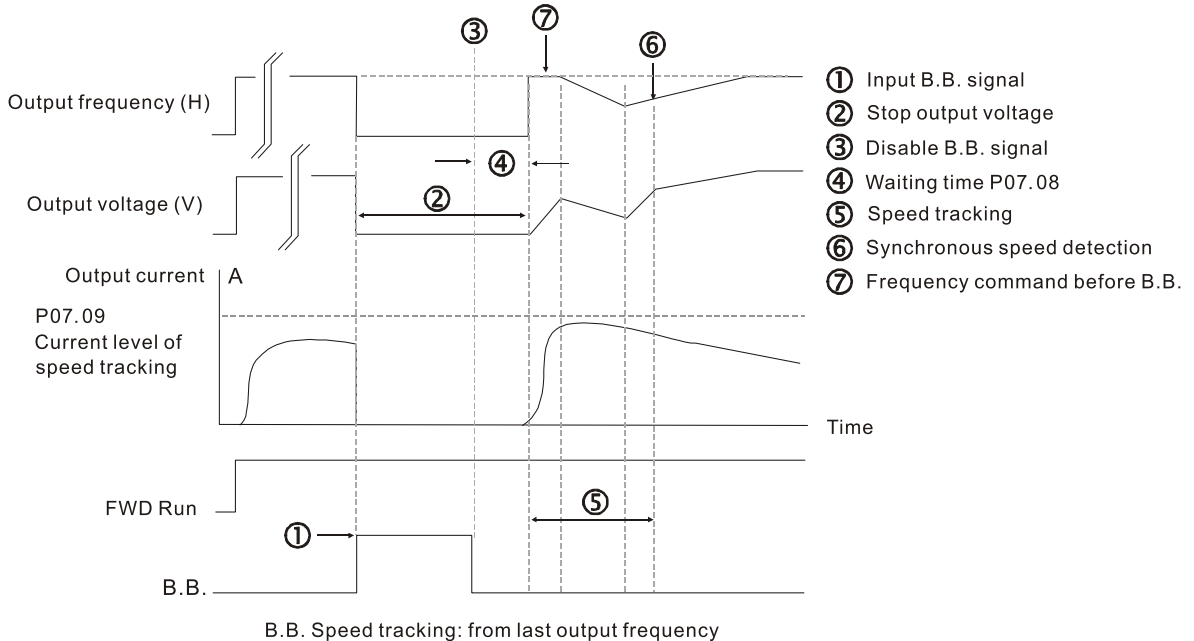

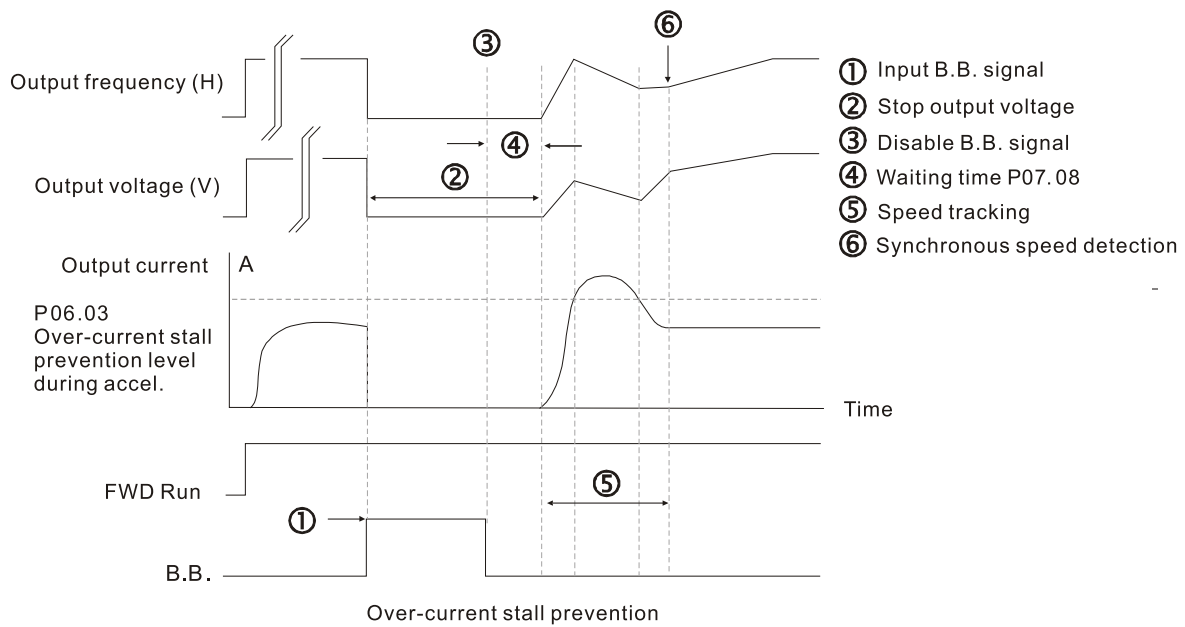
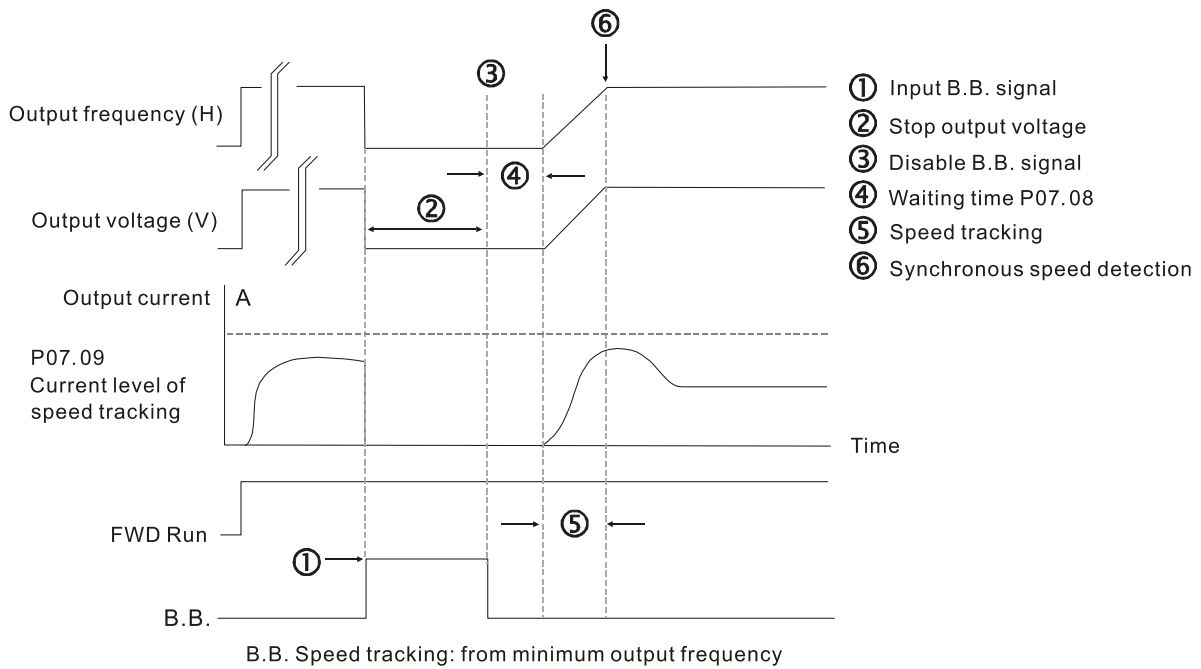

P07.09	Current Limit of Speed Tracking	<i>Type</i>	<i>Hex Addr</i>	<i>Dec Addr</i>
		◆R/W	0709	41802
	<i>Range/Units (Format: 16-bit unsigned)</i>	<i>Default</i>		
	20–200%	100		

The AC motor drive executes speed tracking only when the output current is greater than the value set in P07.09.

The maximum current for speed tracking affects the synchronous time. The larger the parameter setting, the faster the synchronization occurs. However, if the parameter setting is too large, the overload protection function may be activated.

	Type	Hex Addr	Dec Addr
P07.10 Restart after Fault Action	◆R/W	070A	41803
<u>Range/Units (Format: 16-bit binary)</u>	<u>Default</u>		
0: Stop operation	0		
1: Speed tracking by current speed			
2: Speed tracking by minimum output frequency			

In PG control mode, the AC motor drive executes the speed tracking function automatically according to the PG speed when this setting is NOT set to 0.

Faults include: bb, oc, ov, occ. To restart after oc, ov, occ, you can NOT set P07.11 to 0.

	Type	Hex Addr	Dec Addr
P07.11 Number of Times of Restart after Fault	◆R/W	070B	41804
<u>Range/Units (Format: 16-bit unsigned)</u>	<u>Default</u>		
0–10	0		

After fault (allowed fault: oc, ov, occ) occurs, the AC motor drive can reset and restart automatically up to 10 times. If P07.11 is set to 0, the drive resets or restarts automatically after faults occur. The drive starts according to the P07.10 setting after restarting after fault.

If the number of faults exceeds the P07.11 setting, the drive does not reset and restart until you press “RESET” manually and execute the operation command again.

	Type	Hex Addr	Dec Addr
P07.12 Speed Tracking during Start-up	◆R/W	070C	41805
<u>Range/Units (Format: 16-bit binary)</u>	<u>Default</u>		
0: Disable	0		
1: Speed tracking by the maximum output frequency			
2: Speed tracking by the motor frequency at start-up			
3: Speed tracking by the minimum output frequency			

Speed tracking is suitable for punch presses, fans, and other large inertia loads. For example, a punch press usually has a large inertia flywheel, and the general stop method is coast to stop. If it needs to be restarted again, the flywheel may take 2–5 minutes or longer to stop. This parameter setting allows you to start the flywheel operating again without waiting until the flywheel stops completely.

In PG control mode, the AC motor drive executes the speed tracking function automatically according to the PG speed when this setting is NOT set to 0.

	Type	Hex Addr	Dec Addr
P07.13 dEb Function Selection	◆R/W	070D	41806
<u>Range/Units (Format: 16-bit binary)</u>	<u>Default</u>		
0: Disable	0		
1: dEb with auto-acceleration / auto-deceleration, the drive does not output the frequency after the power is restored.			
2: dEb with auto-acceleration / auto-deceleration, the drive outputs the frequency after the power is restored.			
3: dEb low-voltage control, then the drive’s voltage increases to 350 VDC / 700 VDC and ramps to stop after low frequency			
4: dEb high-voltage control of 350 VDC / 700 VDC, and the drive ramps to stop			

- *dEb (Deceleration Energy Backup) lets the motor decelerate to stop when momentary power loss occurs. When the power loss is instantaneous, use this function to let the motor decelerate to zero speed. If the power recovers at this time, the drive restarts the motor after the dEb return time.*
- *Lv return level: Default value depends on the drive power model.*
 - a) *Models for frame A, B, C, D = P06.00 + 75V (575V series) / 60V (460V series) / 30V (120V/230V series)*
 - b) *Models for frame E and above = P06.00 + 80V / 40V (120V/230V series)*
- *Lv level: Default is P06.00.*
- *During dEb operation, other protection, such as ryF, ov, oc, occ, and EF may interrupt it, and these error codes are recorded.*
- *The STOP (RESET) command does not work during the dEb auto-deceleration, and the drive continues decelerating to stop. To make the drive coast to stop immediately, use another function (EF) instead.*
- *The B.B. function does not work when executing dEb. The B.B. function is enabled after the dEb function finishes.*
- *Even though the Lv warning does not display during dEb operation, if the DC bus voltage is lower than the Lv level, DOx = 10 (Low voltage warning) still operates.*
- *The following explains the dEb action:*
When the DC bus voltage drops below the dEb setting level, the dEb function starts to work (soft start relay remains closed), and the drive executes auto-deceleration.

Situation 1:

Momentary power loss, or too low and unstable power voltage, or power supply sliding down because of sudden heavy load. P07.13 = 1 and power recovers.

When the power recovers and DC bus voltage exceeds the dEb return level, the drive linearly decelerates to 0Hz and stops. The keypad displays the “dEb” warning until you manually reset it, so you can see the reason for the stop.

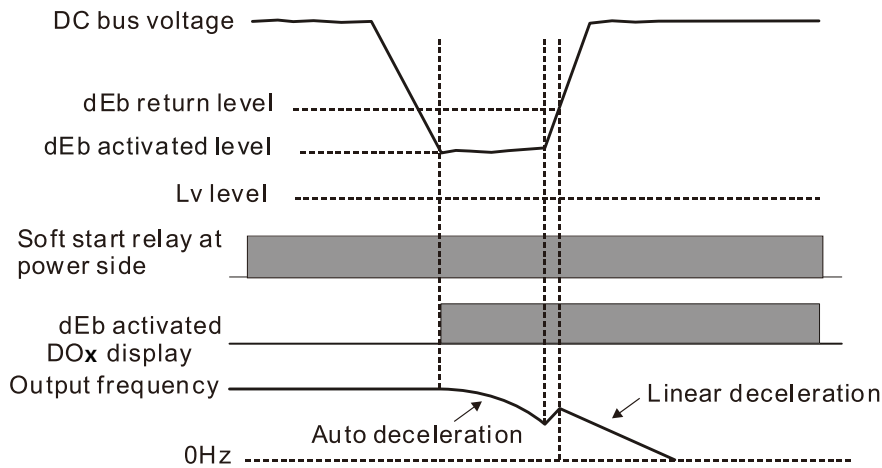

Situation 2:

Momentary power loss, or too low and unstable power voltage, or power supply sliding down because of sudden heavy load. P07.13 = 2 and power recovers.

During the dEb deceleration (includes 0Hz run), if the power recovers to a voltage higher than dEb return level, the drive maintains the frequency for three seconds and then accelerates again. The “dEb” warning on the keypad is automatically cleared.

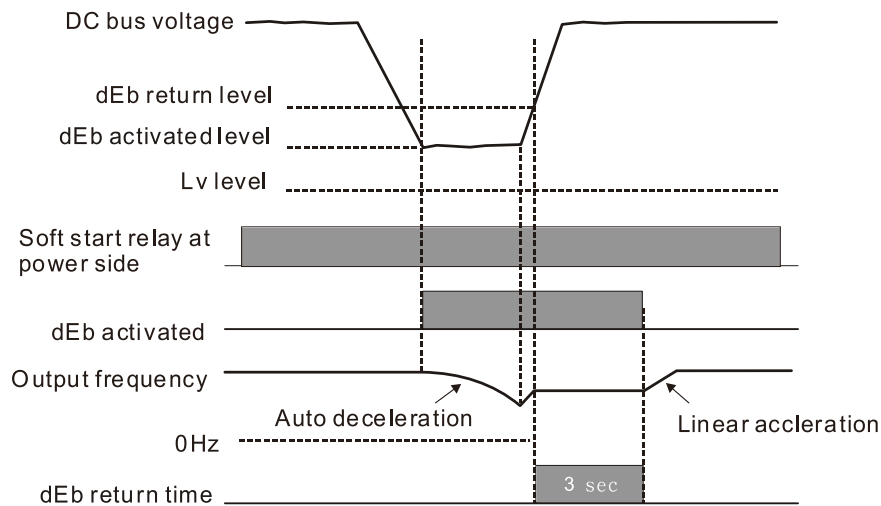

Situation 3:

Unexpected power shut down or power loss. P07.13 = 1 and power does not recover. The keypad displays the “dEb” warning and the drive stops after decelerating to the lowest operating frequency. When the DC bus voltage is lower than the Lv level, the drive disconnects the soft start relay until the power completely runs out.

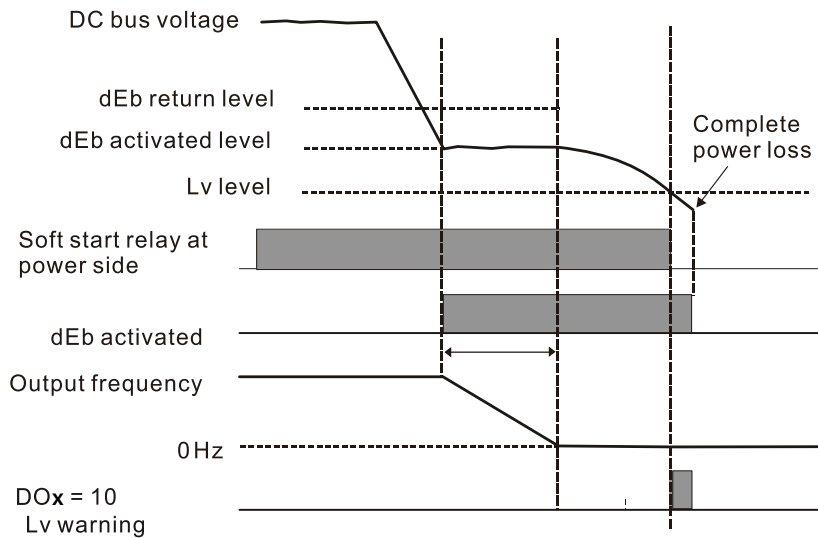

Situation 4:

Unexpected power shut down or power loss. P07.13 = 2 and power does not recover. The drive decelerates to 0 Hz. The DC bus voltage continues to decrease until the voltage is lower than the Lv level, and then the drive disconnects the soft start relay. The keypad displays “dEb” warning until the drive completely runs out of power.

Situation 5:

P07.13 = 2 and power recovers after the DC bus voltage is lower than the Lv level.

The drive decelerates to 0Hz. The DC bus voltage continues to decrease until the voltage is lower than the Lv level, and then the drive disconnects the soft start relay. The soft start relay closes again after the power recovers and the DC bus voltage is higher than the Lv return level. When the DC bus voltage is higher than the dEb return level, the drive maintains the frequency for three seconds and starts to accelerate linearly. The “dEb” warning on the keypad is automatically cleared.

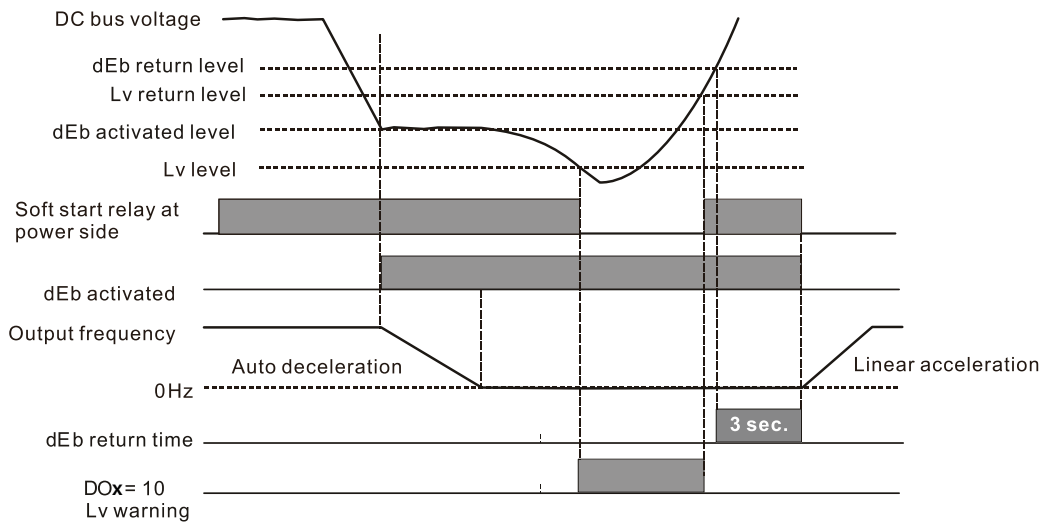

	Type	Hex Addr	Dec Addr
P07.15 Dwell Time at Acceleration	◆R/W	070F	41808
P07.17 Dwell Time at Deceleration	◆R/W	0711	41810
<i>Range/Units (Format: 16-bit unsigned)</i>	<i>Default</i>		
0.00–600.00 sec	0.00		
	Type	Hex Addr	Dec Addr
P07.16 Dwell Frequency at Acceleration	◆R/W	0710	41809
P07.18 Dwell Frequency at Deceleration	◆R/W	0712	41811
<i>Range/Units (Format: 16-bit unsigned)</i>	<i>Default</i>		
0.00–599.00 Hz	0.00		

In constant torque situations, the Dwell temporarily maintains stable output frequency. Use this parameter for cranes, elevators, and so on.

For constant torque applications, use P07.15–P07.18 to avoid OV or OC protection.

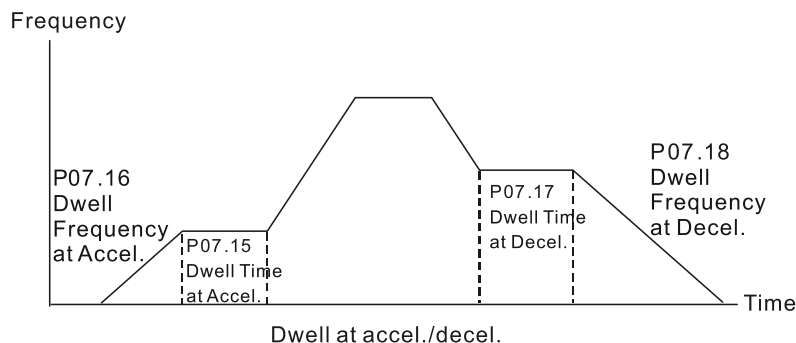

P07.19 Fan Cooling Control	Type	Hex Addr	Dec Addr
	◆R/W	0713	41812
<i>Range/Units (Format: 16-bit binary)</i>	<i>Default</i>		
0: Fan is always ON	3		
1: Fan is OFF after the AC motor drive stops for one minute.			
2: Fan is ON when the AC motor drive runs; fan is OFF when the AC motor drive stops			
3: Fan turns ON when the temperature (IGBT) reaches around 60°C.			

Use P07.19 to control the fan.

- P07.19 = 0: Fan runs immediately when the drive power is turned ON.
- P07.19 = 1: Fan runs when the AC motor drive runs. One minute after the AC motor drive stops, the fan is OFF.
- P07.19 = 2: Fan runs when the AC motor drive runs and stops immediately when the AC motor drive stops.
- P07.19 = 3: When temperature of the IGBT or capacitors is higher than 60°C, the fan runs. When both the temperature of the IGBT and capacitors are lower than 40°C, the fan stops.

P07.20 Emergency Stop (EF) & Force to Stop Selection	Type	Hex Addr	Dec Addr
	◆R/W	0714	41813
<i>Range/Units (Format: 16-bit binary)</i>	<i>Default</i>		
0: Coast to stop	0		
1: Stop by the first deceleration time			
2: Stop by the second deceleration time			
3: Stop by the third deceleration time			
4: Stop by the fourth deceleration time			
5: System deceleration			
6: Automatic deceleration			

When the multi-function input terminal setting is set to 10 (EF input) or 18 (force to stop) and the terminal contact is ON, the drive stops according to the setting of this parameter.

- When P07.20 = 5 (system deceleration), the EF deceleration behavior will follow P01.44 setting. If P01.44=0 or 1 & P07.20=5, when EF is ON, the deceleration will be Linear. If P01.44=2 or 3 & P07.20=5, when EF is ON, the deceleration will be Auto deceleration.
- When P07.20 = 6 (auto deceleration), the drive automatically determines the loaded regenerative energy to steadily and smoothly stop the motor in the fastest deceleration time.

P07.21 Automatic Energy-saving Setting	Type	Hex Addr	Dec Addr
	◆R/W	0715	41814
<i>Range/Units (Format: 16-bit binary)</i>	<i>Default</i>		
0: Disable	0		
1: Enable			

When energy-saving is enabled, the motor acceleration/deceleration operates with full voltage. During constant speed operation, it automatically calculates the best voltage value according to the load power. This function is not suitable for fluctuating loads or loads which are nearly full during operation.

When the output frequency is constant (that is, constant operation), the output voltage decreases automatically as the load decreases. Therefore, the drive operates with minimum multiplication of voltage and current (electric power) to reach the energy-saving.

	Type	Hex Addr	Dec Addr
P07.22 Energy-saving Gain	◆R/W	0716	41815
<i>Range/Units (Format: 16-bit unsigned)</i>	<i>Default</i>		
10–1000%	100		

When P07.21 is set to 1, use this parameter to adjust the energy-saving gain. The default is 100%. If the result is not satisfactory, adjust it by decreasing the setting value. If the motor oscillates, then increase the setting value.

In certain applications such as high speed spindles, the temperature rise in the motor is a major concern. When the motor is not in working state, reduce the motor current to a lower level. Reduce this parameter setting to meet this requirement.

	Type	Hex Addr	Dec Addr
P07.23 Automatic Voltage Regulation (AVR) Function	◆R/W	0717	41816
<i>Range/Units (Format: 16-bit binary)</i>	<i>Default</i>		
0: Enable AVR	0		
1: Disable AVR			
2: Disable AVR during deceleration			

The rated voltage of a 220V motor is usually 200VAC, 60Hz / 50Hz, and the input voltage of the AC motor drive may vary from 180–264 VAC, 50Hz / 60Hz. Therefore, when the AC motor drive is used without the AVR function, the output voltage is the same as the input voltage. When the motor runs at the voltage exceeding 12–20% of the rated voltage, it causes higher temperatures, damaged insulation, and unstable torque output, which result in shortened motor lifetime.

The AVR function automatically regulates the output voltage of the AC motor drive to the motor's rated voltage when the input voltage exceeds the motor's rated voltage. For example, if the V/F curve is set at 200VAC, 50Hz and the input voltage is at 200–264 VAC, then the drive automatically reduces the output voltage to the motor to a maximum of 200VAC, 50Hz. If the input voltage is at 180–200 VAC, the output voltage to motor is in direct proportion to the input voltage.

- P07.23 = 0: When the AVR function is enabled, the drive calculates the output voltage according to the actual DC bus voltage. The output voltage does NOT change when the DC bus voltage changes.
- P07.23 = 1: When the AVR function is disabled, the drive calculates the output voltage according to the actual DC bus voltage. The output voltage changes with the DC bus voltage, and may cause insufficient current, over-current or oscillation.
- P07.23 = 2: The drive disables the AVR function only during deceleration to stop, and at this time, you can accelerate the braking to achieve the same result.

When the motor ramps to stop, disable the AVR function to shorten the deceleration time. Then, use with the auto-acceleration and auto-deceleration functions to make the motor's deceleration faster and more stable.

AVR applies to all control modes (P00.10/P00.11). Refer to page 4–59 for function block diagrams of AVR in the drive control loop.

	Type	Hex Addr	Dec Addr
P07.24 Torque Command Filter Time (V/F and SVC Control Mode)	◆R/W	0718	41817
<i>Range/Units (Format: 16-bit unsigned)</i>	<i>Default</i>		
0.001–10.000 sec.	0.050		

When the time constant setting is too large, the control is stable but the control response is slow. When the time constant setting is too small, the control response is faster but the control may be unstable. For optimal setting, adjust the setting based on the control stability or the control response.

	Type	Hex Addr	Dec Addr
P07.25 Slip Compensation Filter Time (V/F and IMSVC Control Mode)	◆R/W	0719	41818
<i>Range/Units (Format: 16-bit unsigned)</i>	<i>Default</i>		
0.001–10.000 sec.	0.100		

Change the compensation response time with P07.24 and P07.25.

If you set P07.24 and P07.25 to 10 seconds, the compensation response time is the slowest; however, the system may be unstable if you set the time too short.

P07.25 is only used for V/F mode (P00.11=0) and IM-SVC mode (P00.11=2). See function block diagram under P00.11 on page 4–59.

	Type	Hex Addr	Dec Addr
P07.26 Torque Compensation Gain (Motor 1)	◆R/W	071A	41819
P07.71 Torque Compensation Gain (Motor 2)	◆R/W	0747	41864
P07.73 Torque Compensation Gain (Motor 3)	◆R/W	0749	41866
P07.75 Torque Compensation Gain (Motor 4)	◆R/W	074B	41868
<i>Range/Units (Format: 16-bit unsigned)</i>	<i>Default</i>		
IM: 0–10 (when P05.33=0)	1		
PM: 0–5000 (when P05.33=1 or 2)			

These parameters apply to P00.11 V/F and SVC control modes.

With a large motor load, a part of the drive output voltage is absorbed by the stator winding resistor; therefore, the air gap magnetic field is insufficient. This causes insufficient voltage at motor induction and results in excessive output current but insufficient output torque.

Auto-torque compensation can automatically adjust the output voltage according to the load and keep the air gap magnetic fields stable to get the optimal operation.

In the V/F control, the voltage decreases in direct proportion with decreasing frequency. The torque decreases at low speed because of a decreasing AC resistor and an unchanged DC resistor. The auto-torque compensation function increases the output voltage at low frequency to get a higher starting torque.

When the compensation gain is set too high, it may cause motor over-flux and result in a too great an output current from the drive, motor overheating or trigger the drive’s protection function.

See function block diagrams under P00.11 on page 4–59.

	Type	Hex Addr	Dec Addr
P07.27 Slip Compensation Gain (Motor 1)	◆R/W	071B	41820
P07.72 Slip Compensation Gain (Motor 2)	◆R/W	0748	41865
P07.74 Slip Compensation Gain (Motor 3)	◆R/W	074A	41867
P07.76 Slip Compensation Gain (Motor 4)	◆R/W	074C	41869
<i>Range/Units (Format: 16-bit unsigned)</i>	<i>Default</i>		
0.00–10.00	0.00 (1 in SVC mode)		

These parameters apply to P00.11 V/F and SVC control modes.

The induction motor needs constant slip to produce electromagnetic torque. It can be ignored at higher motor speeds, such as rated speed or 2–3% of slip.

However, during the drive operation, the slip and the synchronous frequency are in reverse proportion to produce the same electromagnetic torque. The slip is larger with the reduction of the synchronous frequency. Moreover, the motor may stop when the synchronous frequency decreases to a specific value. Therefore, the slip seriously affects the motor speed accuracy at low speed.

In another situation, when you use an induction motor with the drive, the slip increases when the load increases. It also affects the motor speed accuracy.

Use this parameter to set the compensation frequency, and reduce the slip to maintain the synchronous speed when the motor runs at the rated current in order to improve the accuracy of the drive. When the drive output current is higher than P05.05 (No-load Current for Induction Motor 1 (A)), the drive compensates the frequency according to this parameter.

This parameter is set to 1.00 automatically when P00.11 (Speed Control Mode) is changed from V/F mode to vector mode. Otherwise, it is automatically set to 0.00. Apply the slip compensation after load and acceleration. Increase the compensation value from small to large gradually; add the output frequency to the [motor rated slip x P07.27 (Slip Compensation Gain)] when the motor is at the rated load. If the actual speed ratio is slower than expected, increase the parameter setting value; otherwise, decrease the setting value.

See function block diagrams under P00.11 on page 4–59.

	<i>Type</i>	<i>Hex Addr</i>	<i>Dec Addr</i>
P07.29 Slip Deviation Level	◆R/W	071D	41822
<i>Range/Units (Format: 16-bit unsigned)</i>	<i>Default</i>		
0.0–100.0%	0		
0: No detection			

	<i>Type</i>	<i>Hex Addr</i>	<i>Dec Addr</i>
P07.30 Over-slip Deviation Detection Time	◆R/W	071E	41823
<i>Range/Units (Format: 16-bit unsigned)</i>	<i>Default</i>		
0.0–10.0 sec.	1.0		

	<i>Type</i>	<i>Hex Addr</i>	<i>Dec Addr</i>
P07.31 Over-slip Deviation Treatment	◆R/W	071F	41824
<i>Range/Units (Format: 16-bit binary)</i>	<i>Default</i>		
0: Warn and continue operation	0		
1: Fault and ramp to stop			
2: Fault and coast to stop			
3: No warning			

P07.29–P07.31 set the allowable slip level/time and the over-slip treatment when the drive is running.

	<i>Type</i>	<i>Hex Addr</i>	<i>Dec Addr</i>
P07.32 Motor Oscillation Compensation Factor	◆R/W	0720	41825
<i>Range/Units (Format: 16-bit unsigned)</i>	<i>Default</i>		
0–10000	1000		

If there are current wave motions which cause severe motor oscillation in some specific area, setting P07.32 can effectively improve this situation. (When running with high frequency or PG, set this parameter to 0. When the current wave motion occurs in low frequency and high power, increase the value for P07.32.)

	<i>Type</i>	<i>Hex Addr</i>	<i>Dec Addr</i>
P07.33 Auto-restart Interval of Fault	◆R/W	0721	41826
<i>Range/Units (Format: 16-bit unsigned)</i>	<i>Default</i>		
0.0–6000.0 sec.	60.0		

When a reset/restart occurs after a fault, the drive uses P07.33 as a timer and starts counting the number of faults within this time period. Within this period, if the number of faults does not exceed the setting for P07.11, the counting clears and starts from 0 when the next fault occurs.

P07.38	PMSVC Voltage Feed Forward Gain	Type	Hex Addr	Dec Addr
	<i>Range/Units (Format: 16-bit unsigned)</i>	R/W	0726	41831
	0.50–2.00	Default		
			1.00	
P07.46	OOB Sampling Time	Type	Hex Addr	Dec Addr
	<i>Range/Units (Format: 16-bit unsigned)</i>	R/W	072E	41839
	0.1–120.0 sec.	Default		
			1.0	
P07.47	Number of OOB Sampling Times	Type	Hex Addr	Dec Addr
	<i>Range/Units (Format: 16-bit unsigned)</i>	R/W	072F	41840
	00–32	Default		
			20	
P07.48	OOB Average Sampling Angle	Type	Hex Addr	Dec Addr
	<i>Range/Units (Format: 16-bit unsigned)</i>	Read	0730	41841
	Read only	Default		
			0	

You can use the OOB (Out Of Balance Detection) function with a PLC program in a washing machine system. When the multi-function input terminal P02.01–P02.07 is set to 82 (OOB loading balance detection), the P07.48 (OOB Average Sampling Angle) $\Delta\theta$ value is set according to P07.46 (OOB Sampling Time) and P07.47 (Number of OOB Sampling Times).

The PLC or host controller would be configured to read P07.48 and programmed to determine the motor speed according to P07.48 (OOB Average Sampling Angle) $\Delta\theta$ value. When the Average Sampling Angle $\Delta\theta$ value is large, the load is unbalanced. In this case, the PLC or host controller must decrease the Frequency command. Otherwise, increase the Frequency command to execute high speed operations when P07.48 $\Delta\theta$ value is small.

Related parameters:

P02.01–P02.07 (Multi-function Input Commands).

P07.62	dEb Gain (Kp)	Type	Hex Addr	Dec Addr
	<i>Range/Units (Format: 16-bit unsigned)</i>	◆R/W	073E	41855
	0–65535	Default		
			8000	
P07.63	dEb Gain (Ki)	Type	Hex Addr	Dec Addr
	<i>Range/Units (Format: 16-bit unsigned)</i>	◆R/W	073F	41856
	0–65535	Default		
			150	

These parameters set the PI gain of DC bus voltage controller when the dEb function activates. If the DC bus voltage drops too fast, or the speed oscillation occurs during deceleration after the dEb function activates, adjust P07.62 and P07.63. Increase the Kp setting to quicken the control response, but oscillation may occur if the setting is too large. Use Ki parameter to decrease the steady-state error to zero, and increase the setting to quicken the response speed.

GROUP P08.xx DETAILS – HIGH-FUNCTION PID PARAMETERS

	Type	Hex Addr	Dec Addr
P08.00 Terminal Selection of PID Feedback	◆R/W	0800	42049
<i>Range/Units (Format: 16-bit binary)</i>	<i>Default</i>		
0: No function	0		
1: Negative PID feedback: by analog input (P03.00, P03.01)			
2: Negative PID feedback: by single-phase input (PG/DI7), without direction (P10.16=5)			
4: Positive PID feedback: by analog input (P03.00, P03.01)			
5: Positive PID feedback: by single-phase input (PG/DI7), without direction (P10.16=5)			
7: Negative PID feedback: by communication protocols			
8: Positive PID feedback: by communication protocols			

Negative feedback:

Error = + Target value (set point) – Feedback. Use negative feedback when the detection value increases if the output frequency increases.

Positive feedback:

Error = Target value (set point)+ Feedback. Use positive feedback when the detection value decreases if the output frequency increases.

When P08.00 ≠ 7 or ≠ 8, the input value is disabled. The setting value does not remain when the drive is powered off.

- 1) Common applications for PID control:
 - a) Flow control: Use a flow sensor to feedback the flow data and perform accurate flow control.
 - b) Pressure control: Use a pressure sensor to feedback the pressure data and perform precise pressure control.
 - c) Air volume control: Use an air volume sensor to feedback the air volume data to achieve excellent air volume regulation.
 - d) Temperature control: Use a thermocouple or thermistor to feedback temperature data for comfortable temperature control.
 - e) Speed control: Use a speed sensor to feedback motor shaft speed or input another machine speed as a target value for synchronous control.
- 2) PID control loop:

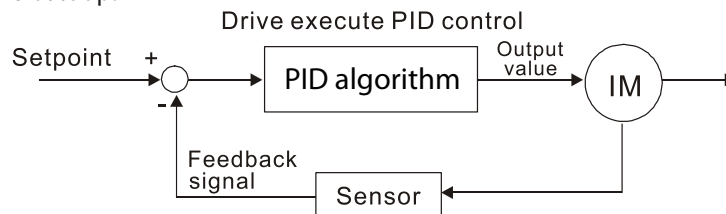

- 3) Concept of PID control:
 - a) Proportional gain (P): The output is proportional to input. With only a proportional gain control, there is always a steady-state error.
 - b) Integral time (I): The controller output is proportional to the integral of the controller input. When an automatic control system is in a steady state and a steady-state error occurs, the system is called a System with Steady-state Error. To eliminate the steady-state error, add an “integral part” to the controller. The integral time controls the relation between the integral part and the error. The integral part increases over time even if the error is small. It gradually increases the controller output to eliminate the error until it is zero. This stabilizes the system without a steady-state error by using proportional gain control and integral time control.

- c) Differential control (D): The controller output is proportional to the differential of the controller input. During elimination of the error, oscillation or instability may occur. Use the differential control to suppress these effects by acting before the error. That is, when the error is near 0, the differential control should be 0. Use proportional gain (P) and differential control (D) to improve the system state during PID adjustment.
- 4) Using PID control in a constant pressure pump feedback application:
 Set the application's constant pressure value (bar) to be the set point of PID control. The pressure sensor sends the actual value as the PID feedback value. After comparing the PID set point and PID feedback, an error displays. The PID controller calculates the output by using proportional gain (P), integral time (I) and differential time (D) to control the pump. It controls the drive to use a different pump speed and achieves constant pressure control by using a 4–20 mA signal corresponding to 0–10 bar as feedback to the drive.

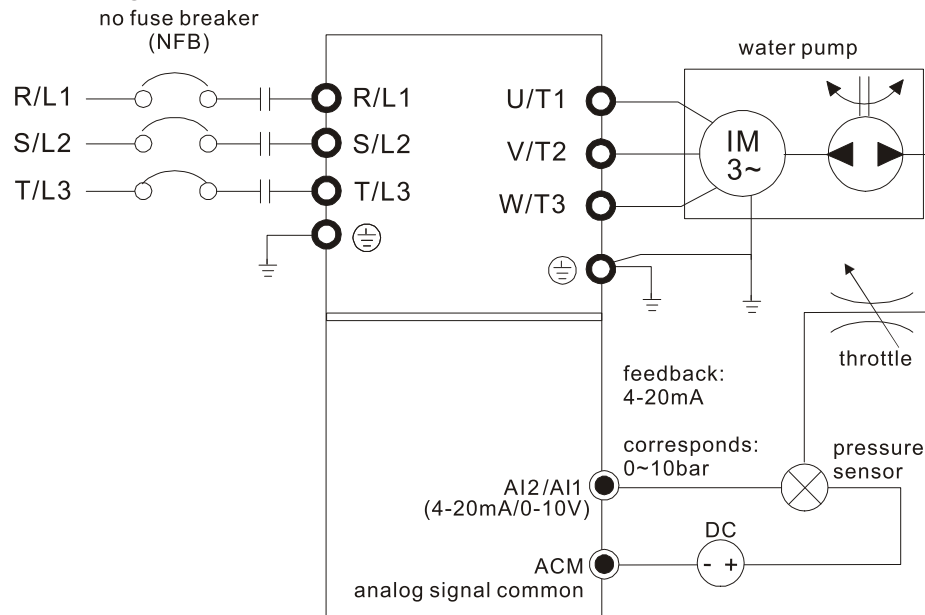

- P00.04 = 10 (display PID feedback (b) (%))
- P01.12 Acceleration Time is set according to actual conditions.
- P01.13 Deceleration Time is set according to actual conditions.
- P00.21 = 0, operate through the digital keypad
- P00.20 = 0, the digital keypad controls the set point.
- P08.00 = 1 (negative PID feedback from analog input)
- AI2 analog input P03.01 = 5, PID feedback signal.
- P08.01-P08.03 is set according to actual conditions.
- If there is no oscillation in the system, increase P08.01 (Proportional Gain (P))
- If there is no oscillation in the system, decrease P08.02 (Integral Time (I))
- If there is no oscillation in the system, increase P08.03 (Differential Time (D))
- Refer to P08.00–P08.21 for PID parameter settings.

	<i>Type</i>	<i>Hex Addr</i>	<i>Dec Addr</i>
P08.01 Proportional Gain (P)	◆R/W	0801	42050
<i>Range/Units (Format: 16-bit unsigned)</i>	<i>Default</i>		
0.0–1000.0 (When P08.23 bit 1 = 0)	1.00		
0.00–100.00 (When P08.23 bit 1 = 1)			

Sets the proportional gain to determine the deviation response speed. The higher the proportional gain, the faster the response speed. Eliminates the system deviation; usually used to decrease the deviation and get faster response speed. If you set the value too high, overshoot occurs and it may cause system oscillation and instability.

When P08.01 = 1.0: Kp gain is 100%; if the setting is 0.5, Kp gain is 50%.

If you set the other two gains (I and D) to zero, proportional control is the only effective parameter.

	<i>Type</i>	<i>Hex Addr</i>	<i>Dec Addr</i>
P08.02 Integral Time (I)	◆R/W	0802	42051
<i>Range/Units (Format: 16-bit unsigned)</i>	<i>Default</i>		
0.00–100.00 sec.	1.00		

Use the integral controller to eliminate deviation during stable system operation. The integral control does not stop working until the deviation is zero. The integral is affected by the integral time. The smaller the integral time, the stronger the integral action. It is helpful to reduce overshoot and oscillation for a stable system. Accordingly, the speed to lower the steady-state deviation decreases. Integral control is often used with the other two controls for the PI controller or PID controller.

Sets the integral time of the I controller. When the integral time is long, there is a small I controller gain, with slower response and slow external control. When the integral time is short, there is a large I controller gain, with faster response and rapid external control.

- When the integral time is too short, it may cause overshoot or oscillation for the output frequency and system.
- Set Integral Time to 0.00 to disable the I controller.

	<i>Type</i>	<i>Hex Addr</i>	<i>Dec Addr</i>
P08.03 Differential Time (D)	◆R/W	0803	42052
<i>Range/Units (Format: 16-bit unsigned)</i>	<i>Default</i>		
0.00–1.00 sec.	0.00		

Use the differential controller to show the system deviation change, as well as to preview the change in the deviation. You can use the differential controller to eliminate the deviation in order to improve the system state. Using a suitable differential time can reduce overshoot and shorten adjustment time; however, the differential operation increases noise interference. Note that a too large differential causes more noise interference. In addition, the differential shows the change and the differential output is 0 when there is no change. Note that you cannot use the differential control independently. You must use it with the other two controllers for the PD controller or PID controller.

Sets the D controller gain to determine the deviation change response. Using a suitable differential time reduces the P and I controllers overshoot to decrease the oscillation for a stable system. A differential time that is too long may cause system oscillation.

The differential controller acts on the change in the deviation and cannot reduce interference. Do not use this function when there is significant interference.

	Type	Hex Addr	Dec Addr
P08.04 Upper Limit of Integral Control	◆R/W	0804	42053
<i>Range/Units (Format: 16-bit unsigned)</i>	<i>Default</i>		
0.0–100.0%	100.0		

P08.04 defines an upper bound for the integral gain (I) and therefore limits the master frequency. The formula is: Integral upper bound = Maximum Operation Frequency (P01.00) x (P08.04%). An excessive integral value causes a slow response due to sudden load changes and may cause motor stall or machine damage. If so, decrease it to a proper value.

	Type	Hex Addr	Dec Addr
P08.05 PID Output Command Limit (Positive Limit)	◆R/W	0805	42054
<i>Range/Units (Format: 16-bit unsigned)</i>	<i>Default</i>		
0.0–110.0%	100.0		

P08.05 defines the percentage of the output frequency limit during the PID control. The formula is Output Frequency Limit = Maximum Operation Frequency (P01.00) x P08.05%.

	Type	Hex Addr	Dec Addr
P08.06 PID Feedback Value by Communication Protocol	◆R/W	0806	42055
<i>Range/Units (Format: 16-bit signed)</i>	<i>Default</i>		
-200.00–200.00%	0.00		

Use communications to set the PID feedback value when the PID feedback input is set to communications (P08.00 = 7 or 8).

	Type	Hex Addr	Dec Addr
P08.07 PID Delay Time	◆R/W	0807	42056
<i>Range/Units (Format: 16-bit unsigned)</i>	<i>Default</i>		
0.0–2.5 sec.	0.0		

P08.07 determines the primary low pass filter time when in PID control. Setting a large time constant may slow down the drive’s response speed.

PID control output frequency is filtered with a primary low pass function. This function can filter a mix of frequencies. A long primary low pass time means the filter degree is high and a short primary low pass time means the filter degree is low.

Inappropriate delay time setting may cause system oscillation.

	Type	Hex Addr	Dec Addr
P08.08 Feedback Signal Detection Time	◆R/W	0808	42057
<i>Range/Units (Format: 16-bit unsigned)</i>	<i>Default</i>		
0.0–3600.0 sec.	0.0		

Valid only when the feedback signal is AI2 (4–20 mA).

P08.08 sets the detection time for abnormal PID signal feedback. You can also use it when the system feedback signal response is extremely slow. (Setting the detection time to 0.0 disables the detection function.)

P08.09	Feedback Signal Fault Treatment	<u>Type</u>	<u>Hex Addr</u>	<u>Dec Addr</u>
		◆R/W	0809	42058
	<u>Range/Units (Format: 16-bit binary)</u>	<u>Default</u>		
	0: Warn and continue operation	0		
	1: Fault and ramp to stop			
	2: Fault and coast to stop			
	3: Warn and operate at last frequency			

Valid only when the feedback signal is AI2 (4–20 mA).

Sets the treatments when the PID feedback signal is abnormal.

P08.10	Sleep Frequency	<u>Type</u>	<u>Hex Addr</u>	<u>Dec Addr</u>
		◆R/W	080A	42059
	<u>Range/Units (Format: 16-bit unsigned)</u>	<u>Default</u>		
	0.00–599.00 Hz (P08.18=0)	0.00		
	0.00–200.00% (P08.18=1)			

P08.10 determines the sleep frequency, and if the sleep time and the wake-up frequency are enabled or disabled.

- P08.10 = 0: Disabled
- P08.10 ≠ 0: Enabled

P08.11	Wake-up Frequency	<u>Type</u>	<u>Hex Addr</u>	<u>Dec Addr</u>
		◆R/W	080B	42060
	<u>Range/Units (Format: 16-bit unsigned)</u>	<u>Default</u>		
	0.00–599.00 Hz (P08.18=0)	0.00		
	0.00–200.00% (P08.18=1)			

When P08.18=0, the unit for P08.10 and that for P08.11 switch to frequency. The settings are between 0.00–599.00 Hz.

When P08.18=1, the unit for P08.10 and that for P08.11 switch to percentage. The settings are between 0.00–200.00%.

- The percentage is based on the current setpoint value, not the maximum value. For example, if the maximum value is 100kg, and the current setpoint value is 30kg, then if P08.11=40%, the value is 12kg.
- P08.10 uses the same logic for calculation.

P08.12	Sleep Time	<u>Type</u>	<u>Hex Addr</u>	<u>Dec Addr</u>
		◆R/W	080C	42061
	<u>Range/Units (Format: 16-bit unsigned)</u>	<u>Default</u>		
	0.0–6000.0 sec.	0.0		

When the Frequency command is smaller than the sleep frequency and less than the sleep time, the Frequency command is equal to the sleep frequency. However, the Frequency command remains at 0.00 Hz until the Frequency command becomes equal to or larger than the wake-up frequency.

P08.13	PID Feedback Signal Error Deviation Level	<u>Type</u>	<u>Hex Addr</u>	<u>Dec Addr</u>
		◆R/W	080D	42062
	<u>Range/Units (Format: 16-bit unsigned)</u>	<u>Default</u>		
	1.0–50.0%	10.0		

	Type	Hex Addr	Dec Addr
P08.14 PID Feedback Signal Error Deviation Detection Time	◆R/W	080E	42063
<i>Range/Units (Format: 16-bit unsigned)</i>	<i>Default</i>		
0.1–300.0 sec.	5.0		

When the PID control function is normal, it should calculate the value within a period of time that is close to the target value.

Refer to the PID control diagram for details. When executing PID feedback control, if $|\text{PID reference target value} - \text{detection value}| > \text{P08.13 PID Feedback Signal Error Deviation Level}$ and time exceeds P08.14 setting, it is regarded as a PID control fault, and the multi-function output terminal setting 15 (PID feedback error) activates.

	Type	Hex Addr	Dec Addr
P08.15 PID Feedback Signal Filter Time	◆R/W	080F	42064
<i>Range/Units (Format: 16-bit unsigned)</i>	<i>Default</i>		
0.1–300.0 sec.	5.0		

	Type	Hex Addr	Dec Addr
P08.16 PID Compensation Selection	◆R/W	0810	42065
<i>Range/Units (Format: 16-bit binary)</i>	<i>Default</i>		
0: Parameter setting	0		
1: Analog input			

When P08.16=0: the setting for P08.17 determines the PID compensation value.

	Type	Hex Addr	Dec Addr
P08.17 PID Compensation	◆R/W	0811	42066
<i>Range/Units (Format: 16-bit signed)</i>	<i>Default</i>		
-100.0–100.0%	0		

The PID compensation value = maximum PID target value × P08.17.

Example:

If the maximum operation frequency P01.00 = 60Hz, and P08.17 = 10.0%, the PID compensation value increases the output frequency 6.00 Hz (60.00 Hz × 100.00% × 10.0% = 6.00 Hz).

	Type	Hex Addr	Dec Addr
P08.18 Sleep Mode Function Setting	R/W	0812	42067
<i>Range/Units (Format: 16-bit binary)</i>	<i>Default</i>		
0: Refer to PID output command	0		
1: Refer to PID feedback signal			

P08.18 determines the setting type for P08.10 and P08.11.

- P08.18 = 0: The unit for P08.10 and P08.11 switch to frequency. The settings are between 0.00–599.00 Hz.
- P08.18 = 1: The unit for P08.10 and P08.11 switch to percentage. The settings are between 0.00–200.00%.

	Type	Hex Addr	Dec Addr
P08.19 Wake-up Integral Limit	◆R/W	0813	42068
<i>Range/Units (Format: 16-bit unsigned)</i>	<i>Default</i>		
0.0–200.0%	50.0		

P08.19 reduces the reaction time from sleep to wake-up.

Defines the wake-up integral frequency limit = (P01.00 × P08.19%)

P08.20 PID Mode Selection		<i>Type</i>	<i>Hex Addr</i>	<i>Dec Addr</i>
		R/W	0814	42069
<i>Range/Units (Format: 16-bit binary)</i>		<i>Default</i>		
0: Dependent ISA PID structure		0		
1: Independent/Parallel PID structure				
<ul style="list-style-type: none"> • P08.20 = 0: Use Dependent (ISA) PID control structure ($K_p, K_p \cdot K_i, K_p \cdot K_d$). • P08.20 = 1: Use Independent/Parallel PID control structure. The proportional gain, integral gain, and differential gain are independent (K_p, K_i, K_d). You can customize the P, I, and D value to fit your application. 				

PI Control:

Controlled only by the P action, so the deviation cannot be entirely eliminated. In general, to eliminate residual deviations, use the P + I controls. When you use the PI control, it eliminates the deviation caused by the targeted value changes and the constant external interferences. However, if the I action is too powerful, it delays the response when there is rapid variation. You can use the P action by itself to control the loading system with the integral components.

PD Control:

When deviation occurs, the system immediately generates an operation load that is greater than the load generated only by the D action to restrain the deviation increment. If the deviation is small, the effectiveness of the P action decreases as well. The control objects include applications with integral component loads, which are controlled by the P action only. Sometimes, if the integral component is functioning, the whole system may oscillate. In this case, use the PD control to reduce the P action’s oscillation and stabilize the system. In other words, this control is useful with no brake function’s loading over the processes.

PID Control:

Use the I action to eliminate the deviation and the D action to reduce oscillation; then combine this with the P action for the PID control. Use the PID method for a control process with no deviations, high accuracy, and a stable system.

Dependent (ISA Control):

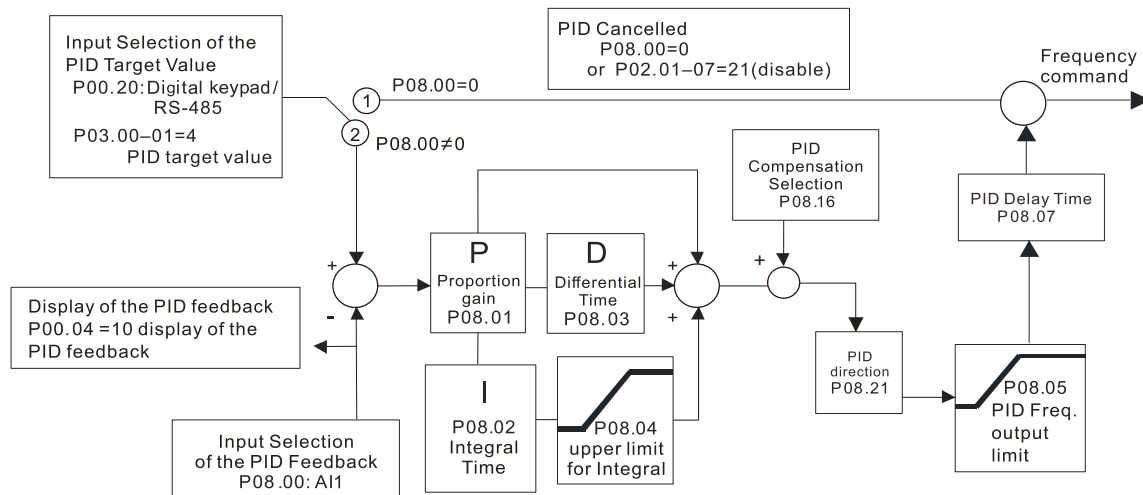

Independent (Parallel) control:

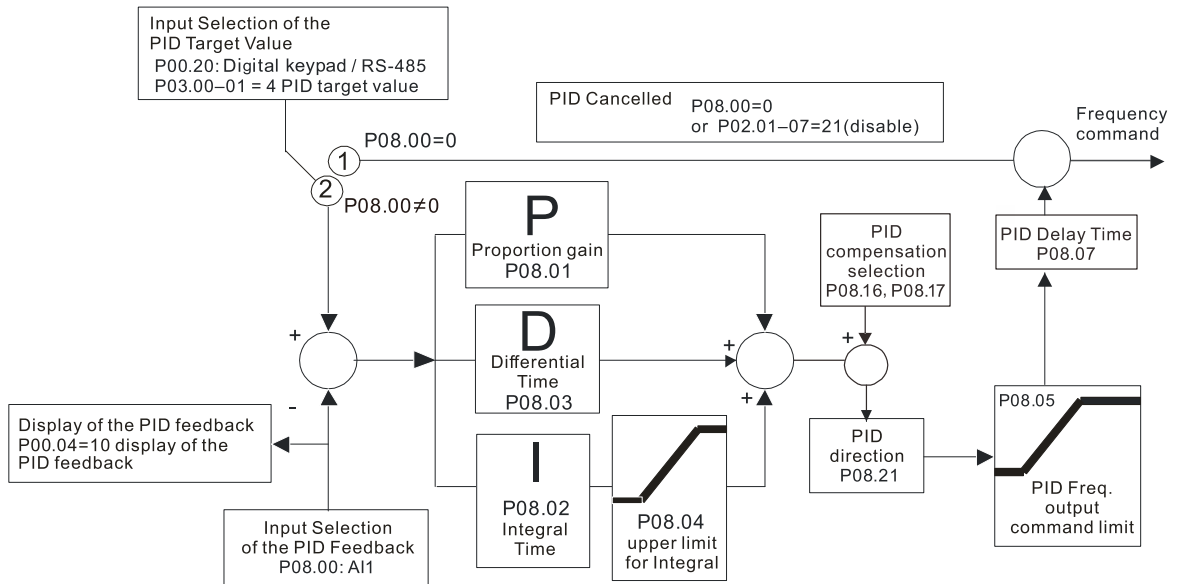

P08.21 Enable PID to Change the Operation Direction

Range/Units (Format: 16-bit binary)
 0: Operation direction cannot be changed
 1: Operation direction can be changed

Type	Hex Addr	Dec Addr
R/W	0815	42070
Default		0

P08.22 Wake-up Delay Time

Range/Units (Format: 16-bit binary)
 0.00–600.00 sec.

Type	Hex Addr	Dec Addr
◆R/W	0816	42071
Default		0.00

Refer to P08.18 and the diagrams in P08.23 for more information.

There are three scenarios for the sleep and wake-up frequency.

- 1) Frequency Command (PID is not in use, P08.00 = 0. Works only in V/F mode)
 When the output frequency \leq the sleep frequency and the drive reaches the preset sleep time, then the drive is in sleep mode (0Hz). When the Frequency command reaches the wake-up frequency, the drive starts to count the wake-up delay time. When the drive reaches the wake-up delay time, it starts to catch up to reach the Frequency command value by the acceleration time.

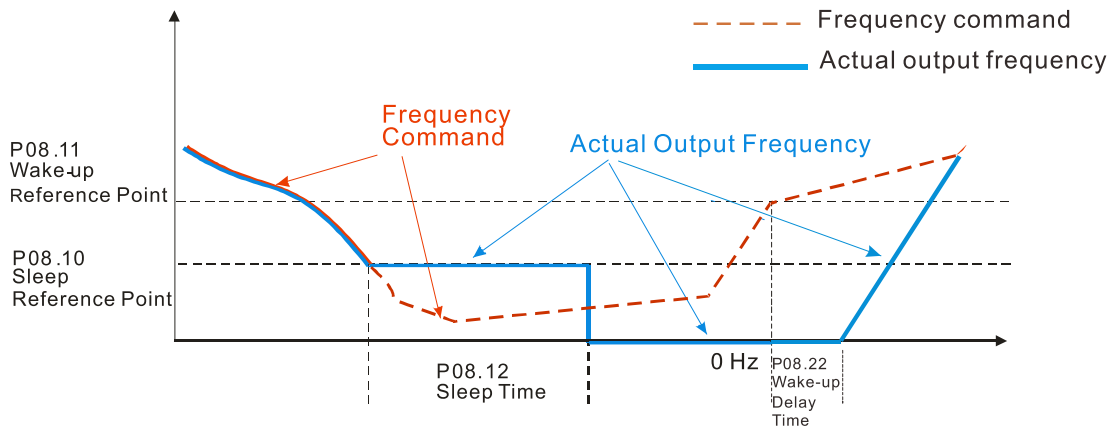

- 2) Internal PID Calculation Frequency Command (PID is in use, P08.00 ≠ 0 and P08.18=0.)
 When the PID calculation Frequency command reaches the sleep frequency, the drive starts to count the sleep time and the output frequency starts to decrease. If the drive exceeds the preset sleep time, then the drive is in sleep mode (0Hz). If the drive does not reach the preset sleep time, it remains at the lower frequency limit (if there is a preset lower limit.), or it remains at the minimum output frequency set for P01.07 and waits until it reaches the sleep time before going into sleep mode (0Hz). When the PID calculated Frequency command reaches the wake-up frequency, the drive starts to count the wake-up delay time. Once it reaches the wake-up delay time, the drive starts to catch up to reach the PID Frequency command value by the acceleration time.

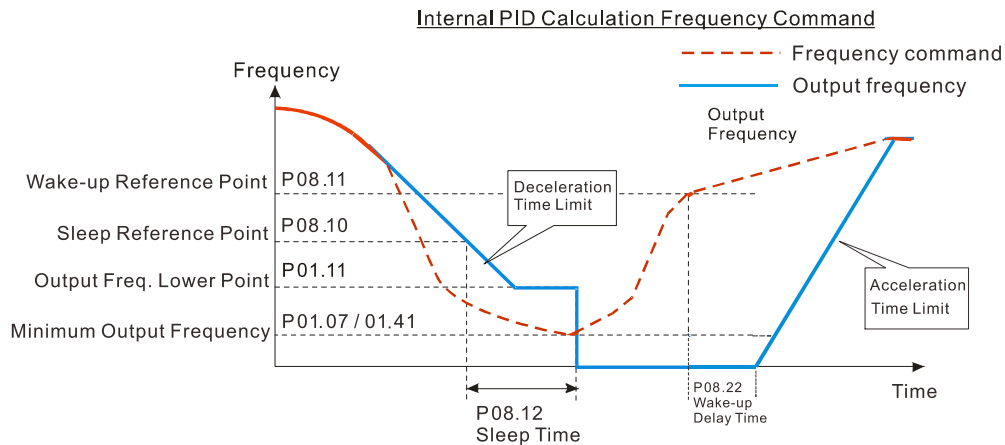

- 3) PID Feedback Value Percentage (PID is in use, P08.00 ≠ 0 and P08.18 = 1)
 When the PID feedback value reaches the sleep level percentage, the drive starts to count the sleep time and the output frequency starts to decrease. If the drive exceeds the preset sleep time, then the drive is in sleep mode (0Hz). If the drive does not reach preset the sleep time, it remains at the lower frequency limit (if there is a preset of lower limit.), or it remains at the minimum output frequency set for P01.07 and waits until it reaches the sleep time before going into sleep mode (0Hz).
 When the PID feedback value reaches the wake-up percentage, the drive starts to count the wake-up delay time. Once it reaches the wake-up delay time, the drive starts to catch up to reach the PID Frequency command value by the acceleration time.

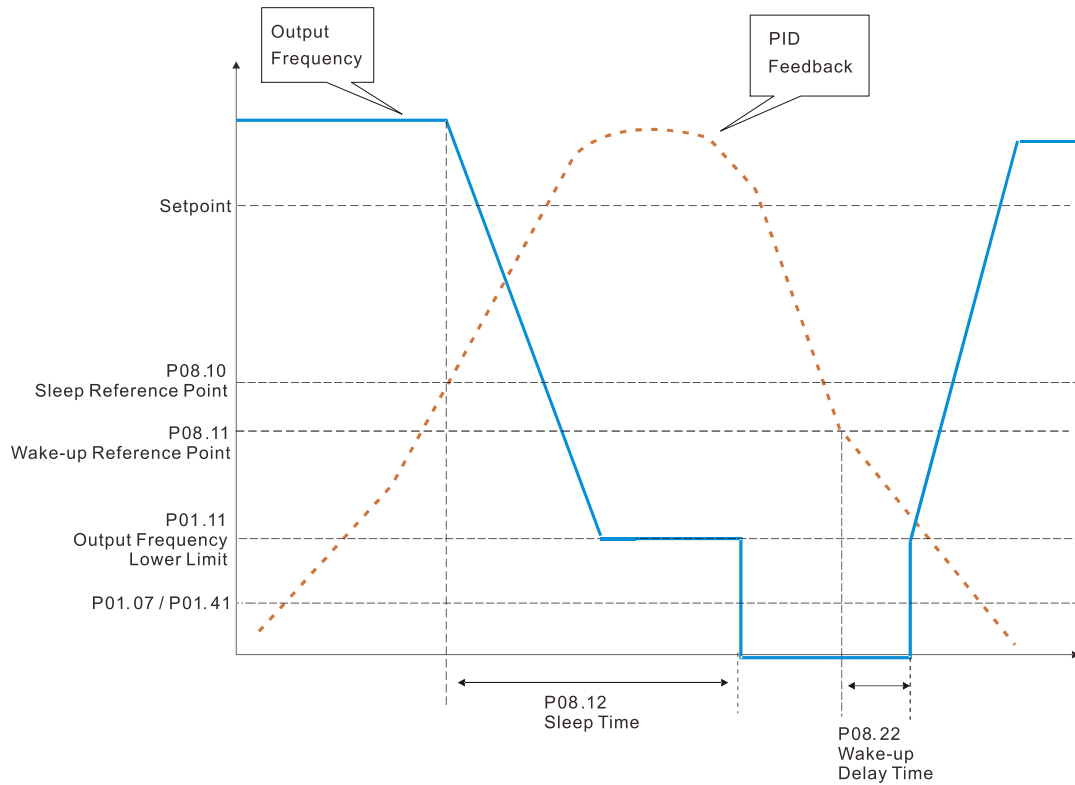

P08.23 PID Control Flag

Range/Units (Format: 16-bit binary)

- bit 0 = 1, PID running in reverse follows the setting for P00.23.
- bit 0 = 0, PID running in reverse refers to PID’s calculated value.
- bit 1 = 1, two decimal places for PID Kp
- bit 1 = 0, one decimal place for PID Kp

P08.23 sets the PID control flag.

- P08.23 bit 0 = 1: PID running in reverse function is valid only when P08.21=1.
- P08.23 bit 0 = 0: If the PID calculated value is positive, the direction is forward. If the PID calculated value is negative, the direction is reverse.

When the bit1 setting changes, the Kp gain does not change. For example: Kp = 6. When P08.23 bit1 = 0, Kp = 6.0; when P08.23 bit1 = 1, Kp = 6.00.

Type	Hex Addr	Dec Addr
◆R/W	0817	42072
<u>Default</u>		
2		

P08.26 PID Output Command Limit (Reverse Limit)

Range/Units (Format: 16-bit unsigned)

0.0–100.0%

Type	Hex Addr	Dec Addr
◆R/W	081A	42075
<u>Default</u>		
100.0		

When PID enables the reverse direction, the PID output is a negative value, and the PID output value is limited by the setting for P08.26. Use this function with P08.21.

	<i>Type</i>	<i>Hex Addr</i>	<i>Dec Addr</i>
P08.27 Acceleration / Deceleration Time for PID Command	◆R/W	081B	42076
<i>Range/Units (Format: 16-bit unsigned)</i>	<i>Default</i>		
0.00–655.35 sec.	0.00		

When P08.27 = 0.00 seconds: Disables the PID acceleration/deceleration command, and the target value is equal to the PID command.

When P08.27 ≠ 0.00 seconds: Enables the PID acceleration/deceleration command. For PID acceleration and deceleration, when the PID target value changes, the command value increment/decrement is executed according to this parameter.

Example:

If we set P08.27 to 10.00 seconds, when PID target value changes from 0% to 100%, it takes 10 seconds for the PID command to change from 0% to 100%. In a similar way, when PID target value changes from 100% to 0%, it takes 10 seconds for the PID command to change from 100% to 0%.

	<i>Type</i>	<i>Hex Addr</i>	<i>Dec Addr</i>
P08.29 Frequency Base Corresponding to 100.00% PID	R/W	081D	42078
<i>Range/Units (Format: 16-bit binary)</i>	<i>Default</i>		
0: PID control output 100.00% corresponding to maximum operation frequency (P01.00)	0		
1: PID control output 100.00% corresponding to the input value of the auxiliary frequency			

Valid only when you enable the master and auxiliary frequency functions.

When P08.29 = 0, PID control outputs 100.00% corresponding to the maximum operation frequency. When P08.29 = 1, PID control outputs 100.00% corresponding to the auxiliary frequency. (The PID output frequency changes when the auxiliary frequency command changes.)

	<i>Type</i>	<i>Hex Addr</i>	<i>Dec Addr</i>
P08.31 Proportional gain 2	◆R/W	081F	42080
<i>Range/Units (Format: 16-bit unsigned)</i>	<i>Default</i>		
0.0–1000.0 (when P08.23 setting bit 1=0)	1.00		
0.00–100.00 (when P08.23 setting bit 1=1)			

	<i>Type</i>	<i>Hex Addr</i>	<i>Dec Addr</i>
P08.32 Integral time 2	◆R/W	0820	42081
<i>Range/Units (Format: 16-bit unsigned)</i>	<i>Default</i>		
0.00–100.00 sec.	1.00		

	<i>Type</i>	<i>Hex Addr</i>	<i>Dec Addr</i>
P08.33 Differential time 2	◆R/W	0821	42082
<i>Range/Units (Format: 16-bit binary)</i>	<i>Default</i>		
0.00–1.00 sec.	0.00		

P08.65 PID Target Value Source

Range/Units (Format: 16-bit binary)

- 0: Frequency command (P00.20, P00.30)
- 1: P08.66 setting
- 2: RS-485 communication input
- 3: External analog input (refer to P03.00, P03.01)
- 6: Communication card
- 7: Digital keypad VR/Potentiometer dial (GS20 only)

Type	Hex Addr	Dec Addr
◆R/W	0841	42114
Default		

0

P08.65 selects the target value source for the PID controller.

- When P08.65=0, the maximum operating frequency P01.00 is 60Hz, the error is 100%, and P08.01=1.00, then the output frequency is "1" times the P01.00 maximum operating frequency. Therefore, the output frequency = 60 * 100% * 1=60Hz.
Calculation formula: Output frequency=Fmax (P01.00) * error% ((PID reference value (P00.20 / P00.30) – PID feedback (P08.00)) * P08.01.
- When P08.65≠0, the internal calculation of the proportional gain reduces by 100 times, that is, when P01.00 Fmax=60Hz, error=100%, P08.01=1.00, then the output frequency is "0.01" times the P01.00 Fmax. Therefore, the output frequency=60 * 100% * 0.01=0.6 Hz.
Calculation formula: Output frequency=Fmax (P01.00) * error% ((PID reference value (P08.66) – PID feedback value (P08.00)) * P08.01 * 0.01.
- When P08.65=0, the PID controller architecture shows as the diagram below:

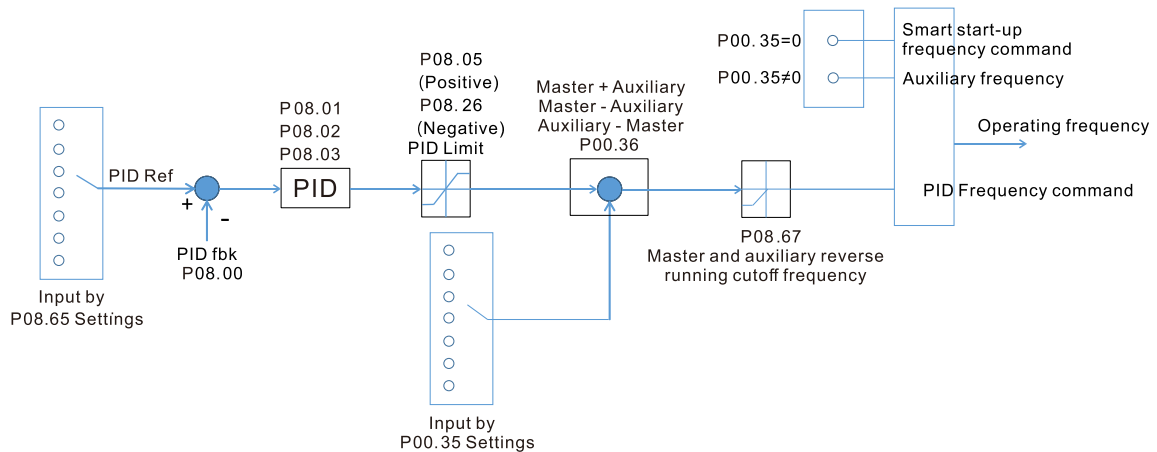

- When P08.65≠0, the PID controller architecture shows as the diagram below:

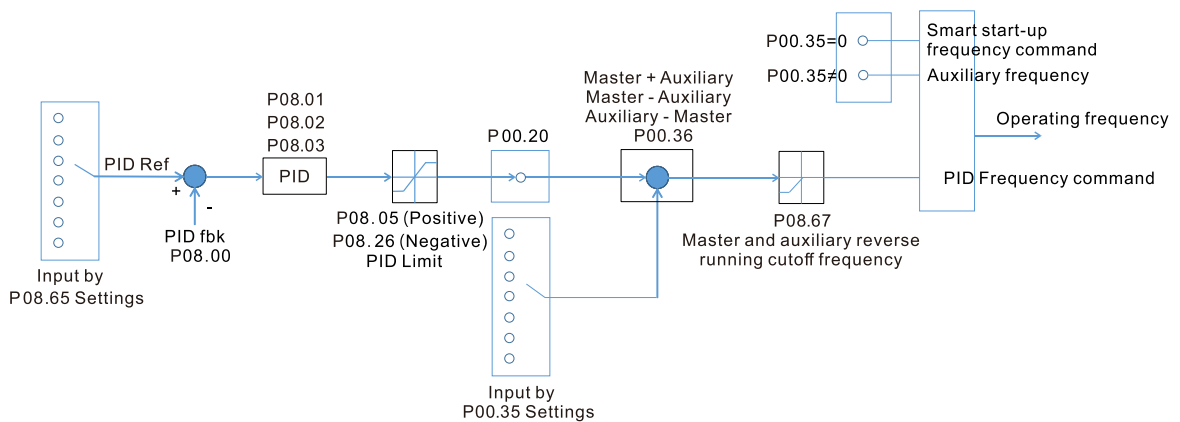

- When P08.65 is not set to 0, P00.20 is automatically set to 9.
- When P08.65 is set to 1, set the PID command through P08.66; when P08.65 is not set to 1, P08.66 displays the PID command.
- When P08.65 is set to 2, 4, and 6, the corresponding communication address is C2003H.

	<i>Type</i>	<i>Hex Addr</i>	<i>Dec Addr</i>
P08.66 PID Target Value Setting	◆R/W	0842	42115
<i>Range/Units (Format: 16-bit signed)</i>	<i>Default</i>		
-100.00–100.00%	50.00		

The target value setting of the PID controller (P08.66) is a relative value.

	<i>Type</i>	<i>Hex Addr</i>	<i>Dec Addr</i>
P08.67 Master and Auxiliary Reverse Running Cutoff Frequency	◆R/W	0843	42116
<i>Range/Units (Format: 16-bit unsigned)</i>	<i>Default</i>		
0.0–100.0%	10.0		

100% corresponds to P01.00 the maximum operation frequency

In some cases, it is only possible for the PID to control the set point and the feedback to the same status when the PID output frequency is negative (the motor runs in reverse). However, an excessively high reverse frequency is not allowed in some cases, and P08.67 is used to determine the upper limit of the reverse frequency

	<i>Type</i>	<i>Hex Addr</i>	<i>Dec Addr</i>
P08.68 PID Deviation Limit	◆R/W	0844	42117
<i>Range/Units (Format: 16-bit unsigned)</i>	<i>Default</i>		
0.00–100.00%	0.00		

When P08.68 is not set to 0, the PID deviation limit function is enabled.

When $\text{PID deviation} \leq \text{PID deviation limit}$, PID stops adjusting, which means the PID output frequency maintains the value at last status. This function is effective for some closed-loop control applications.

	<i>Type</i>	<i>Hex Addr</i>	<i>Dec Addr</i>
P08.69 Integral Separation Level	◆R/W	0845	42118
<i>Range/Units (Format: 16-bit unsigned)</i>	<i>Default</i>		
0.00–100.00%	0.00		

P08.69 reduces overshoot when overshoot occurs in the PID feedback at start-up.

- When P08.69 is not set to 0, the integral separation function is enabled.
- The benchmark for the integral separation level is the PID error%.
- The integral separation function activates only once at start-up.

When $\text{PID deviation} \geq \text{P08.69}$, the integral effect is cancelled to avoid the increasing system overshoot due to the integral effect. When PID deviation is smaller than P08.69, the integral effect is activated to eliminate the steady-state error.

	<i>Type</i>	<i>Hex Addr</i>	<i>Dec Addr</i>
P08.70 Smart Start-up Level	R/W	0846	42119
<i>Range/Units (Format: 16-bit unsigned)</i>	<i>Default</i>		
0.00–100.00%	5.00		

	<i>Type</i>	<i>Hex Addr</i>	<i>Dec Addr</i>
P08.71 Smart Start-up Frequency Command	◆R/W	0847	42120
<i>Range/Units (Format: 16-bit unsigned)</i>	<i>Default</i>		
0.00–599.00 Hz	0.00		

P08.72 Smart Start-up Acceleration Time
 Range/Units (Format: 16-bit unsigned)

Type	Hex Addr	Dec Addr
◆R/W	0848	42121
Default		
		3.00

When P08.71 is not set to 0, the smart start-up function is enabled.

- The benchmark for the smart start-up level is the percentage of PID deviation.
- Use the smart start-up function to reduce overshoot when overshoot occurs in the PID feedback at start-up. The smart start-up activates only once at start-up.

When the smart start-up function is enabled, it starts with the P08.71 frequency and P08.72 acceleration time (P08.72 acceleration time is the time that it accelerates to P08.71). When the PID deviation is smaller than P08.70, it switches to the normal PID control (the smart start-up frequency is filled into the PID integral when switching to PID control to avoid discontinuous frequency).

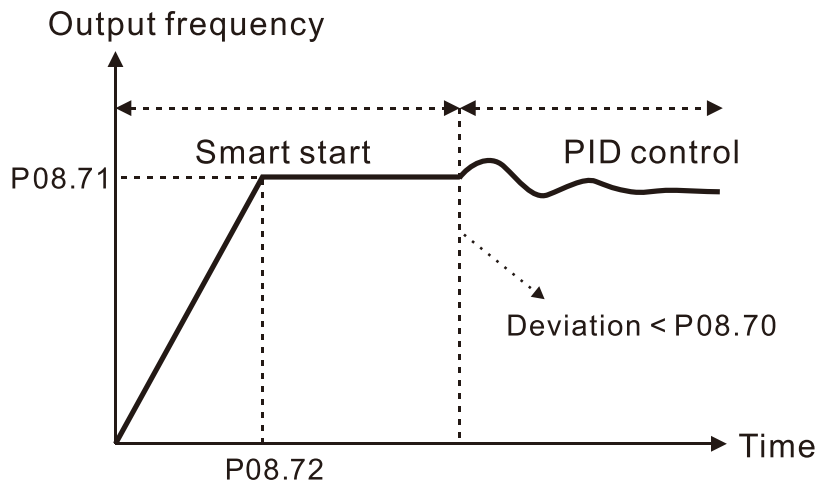

P08.75 PID2 Parameter Switch Condition
 Range/Units (Format: 16-bit binary)
 0: No switching (refer to P08.01–P08.03)
 1: Auto-switch based on the output frequency
 2: Auto-switch based on the deviation

Type	Hex Addr	Dec Addr
◆R/W	084B	42124
Default		
		0

P08.76 PID2 Parameter Switch Deviation 1
 Range/Units (Format: 16-bit unsigned)
 0.00–P08.77%

Type	Hex Addr	Dec Addr
◆R/W	084C	42125
Default		
		10.00

P08.77 PID2 Parameter Switch Deviation 2
 Range/Units (Format: 16-bit unsigned)
 P08.76–100.00%

Type	Hex Addr	Dec Addr
◆R/W	084D	42126
Default		
		40.00

A set of PID parameters cannot meet the requirements of the entire running process in some applications. Use P08.75 to switch to the second set of PID parameters P08.31–P08.33. The setting method for P08.31–P08.33 is the same as that for P08.01–P08.03.

The two sets of PID parameters switch automatically according to the frequency and deviation.

Switch according to the output frequency:

When the output frequency is between P01.07 and P01.00, the PID parameter is the linear interpolation value between the two PID parameter groups.

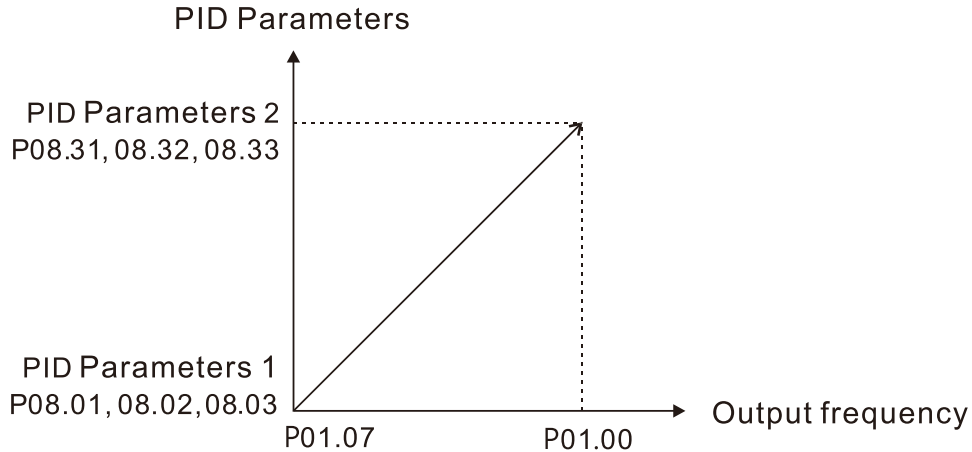

Switch according to the deviation:

- When the deviation absolute value between the set point and feedback is smaller than P08.76 (PID2 Parameter Switch Deviation 1), the first group PID parameters are used.
- When the deviation absolute value between the set point and feedback is larger than P08.77 (PID2 Parameter Switch Deviation 2), the second group PID parameters are used.
- When the deviation absolute value between the set point and feedback is between P08.76 and P08.77, the PID parameter is the linear interpolation value between the two PID parameter groups.

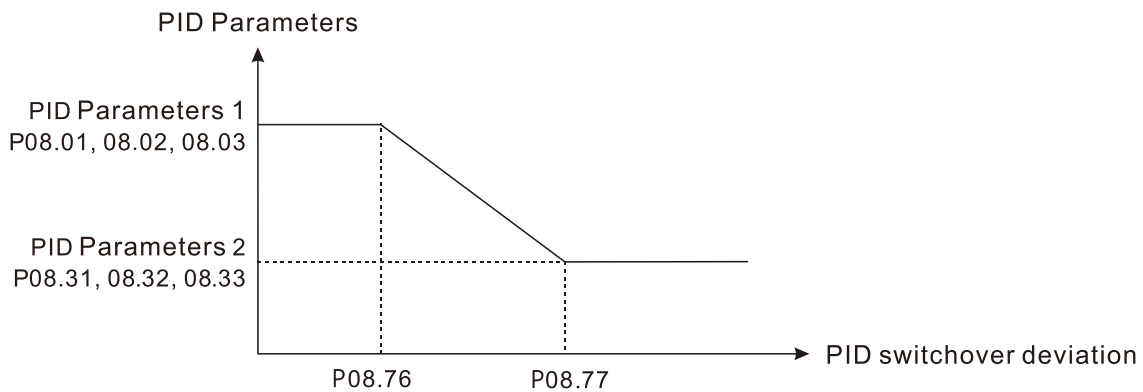

	Type	Hex Addr	Dec Addr
P08.78 Allowed Reverse Running Time after Start-up	◆R/W	084E	42127
<i>Range/Units (Format: 16-bit unsigned)</i>	<i>Default</i>		
0.0–6553.5 sec.	0.0		

When P08.78 is not set to 0, the allowed reverse running time after start-up is enabled.

When it is set to 1 second, the PID control is not allowed to change the running direction within 0–1 seconds of starting time (P08.21=0), and is allowed to change after 1 second of starting time (P08.21=1).

GROUP P09.xx DETAILS – COMMUNICATION PARAMETERS

When connecting the drive to an RS-485 network, the diagram on the right shows the built-in RS-485 communication port pin definitions.

To connect your drive to a PC USB port with GSoft2 software, utilize the GS20 type 2 serial port connection only. This port does not require configuration of the COM1 parameters.

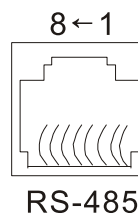

Modbus RS-485
 Pin 1, 2, 6: Reserved
 Pin 3, 7: SGND
 Pin 4: SG-
 Pin 5: SG+
 Pin 8: +10VS

	Type	Hex Addr	Dec Addr
P09.00 COM1 Communication Address	◆R/W	0900	42305
<i>Range/Units (Format: 16-bit unsigned)</i>	<i>Default</i>		
1–254	1		

P09.00 sets the communication address for the drive if the AC motor drive is controlled through RS-485 serial communication. The communication address for each AC drive must be unique.

	Type	Hex Addr	Dec Addr
P09.01 COM1 Transmission Speed	◆R/W	0901	42306
<i>Range/Units (Format: 16-bit unsigned)</i>	<i>Default</i>		
4.8–115.2 Kbps	9.6		

P09.01 sets the transmission speed of the RS-485 port of the drive. Options are 4.8 Kbps, 9.6 Kbps, 19.2 Kbps, 38.4 Kbps, 57.6 Kbps, or 115.2 Kbps; otherwise, the transmission speed is set to the default 9.6 Kbps. For optional GS4-KPD remote keypad, value must be set to 19.2.

	Type	Hex Addr	Dec Addr
P09.02 COM1 Transmission Fault Treatment	◆R/W	0902	42307
<i>Range/Units (Format: 16-bit binary)</i>	<i>Default</i>		
0: Warn and continue operation	3		
1: Fault and ramp to stop			
2: Fault and coast to stop			
3: No warning, no fault, and continue operation			

P09.02 determines the treatment when an error is detected that the host controller does not continuously transmit data to the AC motor drive during Modbus communication. The detection time is based on the P09.03 setting. When a transmission error occurs (for example, the error code CE10 displays), the error remains even if the transmission status returns to normal, and is not cleared automatically. In this case, set a reset command (Reset) to clear the error.

	Type	Hex Addr	Dec Addr
P09.03 COM1 Time-out Detection	◆R/W	0903	42308
<i>Range/Units (Format: 16-bit unsigned)</i>	<i>Default</i>		
0.0–100.0 sec.	0.0		

P09.03 sets the communication time-out value.

		Type	Hex Addr	Dec Addr
P09.04	COM1 Communication Protocol	◆R/W	0904	42309
<i>Range/Units (Format: 16-bit binary)</i>		<i>Default</i>		
1: 7, N, 2 (ASCII)		15		
2: 7, E, 1 (ASCII)				
3: 7, O, 1 (ASCII)				
4: 7, E, 2 (ASCII)				
5: 7, O, 2 (ASCII)				
6: 8, N, 1 (ASCII)				
7: 8, N, 2 (ASCII)				
8: 8, E, 1 (ASCII)				
9: 8, O, 1 (ASCII)				
10: 8, E, 2 (ASCII)				
11: 8, O, 2 (ASCII)				
12: 8, N, 1 (RTU)				
13: 8, N, 2 (RTU)				
14: 8, E, 1 (RTU)				
15: 8, O, 1 (RTU)				
16: 8, E, 2 (RTU)				
17: 8, O, 2 (RTU)				

Control by RS-485 Network

When using the RS-485 serial communication interface, you must specify each drive’s communication address in P09.00. The RS-485 network master then implements control using the drives’ individual addresses.

Modbus ASCII (American Standard Code for Information Interchange): Each byte of data is the combination of two ASCII characters. For example, one byte of data: 64 Hex, shown as ‘64’ in ASCII, consists of ‘6’ (36Hex) and ‘4’ (34Hex).

1) Code Description

The communication protocol is in hexadecimal, ASCII: “0” ... “9”, “A” ... “F”, every hexadecimal value represents an ASCII code. The following table shows some examples.

Character	'0'	'1'	'2'	'3'	'4'	'5'	'6'	'7'
ASCII code	30H	31H	32H	33H	34H	35H	36H	37H

Character	'8'	'9'	'A'	'B'	'C'	'D'	'E'	'F'
ASCII code	38H	39H	41H	42H	43H	44H	45H	46H

2) Data Format

10-bit character frame (For ASCII):

a) (7, N, 2)

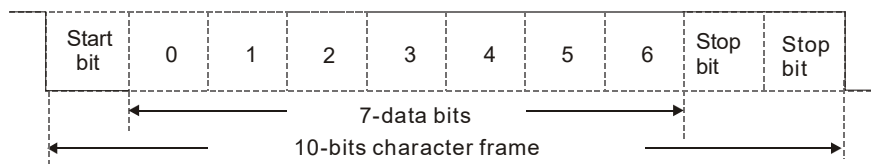

b) (7, E, 1)

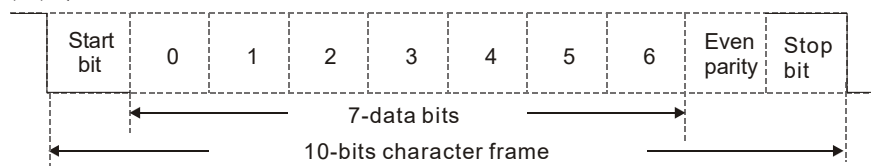

c) (7, 0, 1)

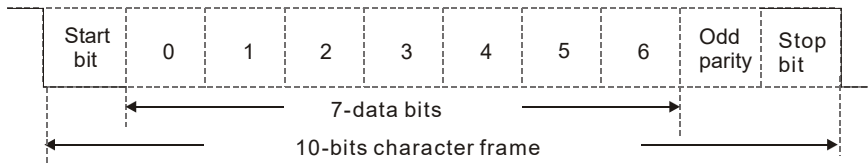

11-bit character frame (For RTU):

a) (8, N, 2)

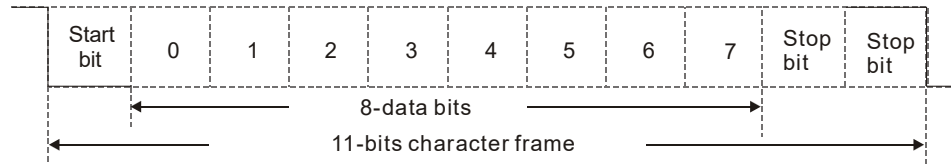

b) (8, E, 1)

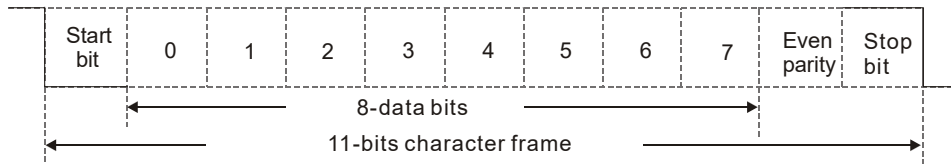

c) (8, 0, 1)

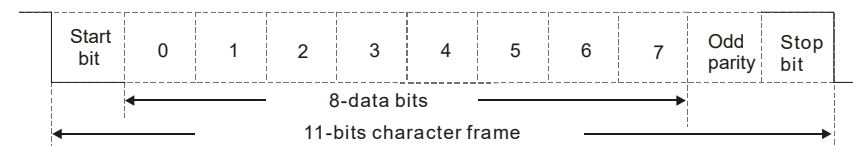

3) Communication Protocol

a) Communication Data Frame

ASCII mode:

STX	Start character = ':' (3AH)
Address High	Communication address: one 8-bit address consists of 2 ASCII codes
Address Low	
Function High	Command code: one 8-bit command consists of 2 ASCII codes
Function Low	
DATA (n-1)	Contents of data: n x 8-bit data consists of 2n ASCII codes n ≤ 16, maximum of 32 ASCII codes (20 sets of data)
.....	
DATA 0	
LRC Check High	LRC checksum: one 8-bit checksum consists of 2 ASCII codes
LRC Check Low	
END High	End characters: END High = CR (0DH), END Low = LF (0AH)
END Low	

RTU mode:

START	Defined by a silent interval of larger than/equal to 10ms
Address	Communication address: 8-bit binary address
Function	Command code: 8-bit binary command
DATA (n-1)	Contents of data: n × 8-bit data, n ≤ 16
.....	
DATA 0	
CRC Check Low	CRC checksum: one 16-bit CRC checksum consists of 2 8-bit binary characters
CRC Check High	
END	Defined by a silent interval of larger than/equal to 10ms

b) Communication Address (Address)

- 00H: Broadcast to all AC motor drives
- 01H: AC motor drive at address 01
- 0FH: AC motor drive at address 15
- 10H: AC motor drive at address 16
- :
- FEH: AC motor drive at address 254

c) Function (Function code) and DATA (Data characters)

i) 03H: Read data from a register

Example: Reading two continuous data from register address 2102H. AMD address is 01H.

ASCII Mode:

Command Message	
STX	':'
Address	'0'
	'1'
Function	'0'
	'3'
Starting register	'2'
	'1'
	'0'
	'2'
Number of register (count by word)	'0'
	'0'
	'0'
	'2'
LRC Check	'D'
	'7'
END	CR
	LF

Response Message	
STX	':'
Address	'0'
	'1'
Function	'0'
	'3'
Number of register (count by byte)	'0'
	'4'
Content of starting register 2102H	'1'
	'7'
	'7'
Content of register 2103H	'0'
	'0'
	'0'
	'0'
LRC Check	'7'
	'1'
END	CR
	LF

RTU Mode:

Command Message	
Address	01H
Function	03H
Starting data register	21H
	02H
Number of register (count by word)	00H
	02H
CRC Check Low	6FH
CRC Check High	F7H

Response Message	
Address	01H
Function	03H
Number of register (count by byte)	04H
Content of register address 2102H	17H
	70H
Content of register address 2103H	00H
	00H
CRC Check Low	FEH
CRC Check High	5CH

- ii) 06H: Single write, write single data to a register
 Example: Writing data 6000 (1770H) to register 0100H. AMD address is 01H.

ASCII Mode:

Command Message	
STX	‘.’
Address	‘0’
	‘1’
Function	‘0’
	‘6’
Target register	‘0’
	‘1’
	‘0’
	‘0’
Register content	‘1’
	‘7’
	‘7’
	‘0’
LRC Check	‘7’
	‘1’
END	CR
	LF

Response Message	
STX	‘.’
Address	‘0’
	‘1’
Function	‘0’
	‘6’
Target register	‘0’
	‘1’
	‘0’
	‘0’
Register content	‘1’
	‘7’
	‘7’
	‘0’
LRC Check	‘7’
	‘1’
END	CR
	LF

RTU Mode:

Command Message	
Address	01H
Function	06H
Target register	01H
	00H
Register content	17H
	70H
CRC Check Low	86H
CRC Check High	22H

Response Message	
Address	01H
Function	06H
Target register	01H
	00H
Register content	17H
	70H
CRC Check Low	86H
CRC Check High	22H

iii) 10H: Write multiple registers (can write at most 20 sets of data simultaneously).

Example: Set the multi-step speed of an AC motor drive (address is 01H):

P04.00 = 50.00 (1388H), P04.01 = 40.00 (0FA0H)

ASCII Mode:

Command Message	
STX	'.'
ADR 1	'0'
ADR 0	'1'
CMD 1	'1'
CMD 0	'0'
Target register	'0'
	'5'
	'0'
	'0'
Number of register (count by word)	'0'
	'0'
	'2'
Number of register (count by Byte)	'0'
	'4'
The first data content	'1'
	'3'
	'8'
	'8'
The second data content	'0'
	'F'
	'A'
	'0'
LRC Check	'9'
	'A'
END	CR
	LF

Response Message	
STX	'.'
ADR 1	'0'
ADR 0	'1'
CMD 1	'1'
CMD 0	'0'
Target register	'0'
	'5'
	'0'
	'0'
Number of register (count by word)	'0'
	'0'
	'2'
LRC Check	'E'
	'8'
END	CR
	LF

RTU Mode:

Command Message	
ADR	01H
CMD	10H
Target register	05H
	00H
Number of register (count by word)	00H
	02H
Quantity of data (byte)	04
The first data content	13H
	88H
The second data content	0FH
	A0H
CRC Check Low	'9'
CRC Check High	'A'

Response Message	
ADR	01H
CMD 1	10H
Target register	05H
	00H
Number of register (count by word)	00H
	02H
CRC Check Low	41H
CRC Check High	04H

d) Checksum

i) ASCII mode (LRC Check):

LRC (Longitudinal Redundancy Check) is calculated by summing up the values of the bytes from ADR1 to the last data character then calculating the hexadecimal representation of the 2's-complement negation of the sum.

For example, as shown in the above Section 3.3.(1),

$01H + 03H + 21H + 02H + 00H + 02H = 29H$, the 2's-complement negation of 29H is D7H.

ii) RTU mode (CRC Check):

CRC (Cyclical Redundancy Check) is calculated by the following steps:

- **Step 1:** Load a 16-bit register (called CRC register) with FFFFH.
- **Step 2:** Exclusive OR the first 8-bit byte of the command message with the low order byte of the 16-bit CRC register, and put the result in the CRC register.
- **Step 3:** Examine the LSB of CRC register.
- **Step 4:** If the LSB of CRC register is 0, shift the CRC register one bit to the right, fill MSB with zero, then repeat step 3. If the LSB of CRC register is 1, shift the CRC register one bit to the right, fill MSB with zero, Exclusive OR the CRC register with the polynomial value A001H, then repeat step 3.
- **Step 5:** Repeat step 3 and 4 until you perform eight shifts. This processes a complete 8-bit byte.
- **Step 6:** Repeat step 2 through 5 for the next 8-bit byte of the command message. Continue doing this until all bytes are processed. The final contents of the CRC register are the CRC value. When transmitting the CRC value in the message, the upper and lower bytes of the CRC value must be swapped, that is, the lower order byte is transmitted first.

The following is an example of CRC generation using C language.

- The function takes two arguments:
Unsigned char data* ← a pointer to the message buffer
Unsigned char length ← the quantity of bytes in the message buffer
- The function returns the CRC value as a type of unsigned integer.

```
Unsigned int crc_chk(unsigned char* data, unsigned char length)
```

```
{
    int j;
    unsigned int reg_crc=0xffff;
    while(length--){
        reg_crc ^= *data++;
        for(j=0;j<8;j++){
            if(reg_crc & 0x01){ /* LSB(b0)=1 */
                reg_crc=(reg_crc>>1) ^ 0xa001;
            }else{
                reg_crc=reg_crc >>1;
            }
        }
    }
    return reg_crc;          // return register CRC
}
```

4) Address list

Content	Function	Hex	Dec	Octal	
AC motor drive parameters	GG is the parameter group, nn is the parameter number; for example, the address of P04.10 is 040AH.	GGnn (ex. 040A)	xxxxx (41035)	yyyyy (2012)	
Command write only	bit 1–0	00B: No function	2000	48193	20000
		01B: Stop			
		10B: Run			
		11B: JOG + RUN			
	bit 3–2	Reserved			
	bit 5–4	00B: No function			
		01B: FWD			
		10B: REV			
		11B: Change direction			
	bit 7–6	00B: 1st accel. / decel.			
		01B: 2nd accel. / decel.			
		10B: 3rd accel. / decel.			
		11B: 4th accel. / decel.			
	bit 11–8	000B: Master speed			
		0001B: 1st step speed frequency			
		0010B: 2nd step speed frequency			
		0011B: 3rd step speed frequency			
		0100B: 4th step speed frequency			
		0101B: 5th step speed frequency			
		0110B: 6th step speed frequency			
		0111B: 7th step speed frequency			
		1000B: 8th step speed frequency			
		1001B: 9th step speed frequency			
		1010B: 10th step speed frequency			
		1011B: 11th step speed frequency			
		1100B: 12th step speed frequency			
		1101B: 13th step speed frequency			
1110B: 14th step speed frequency					
1111B: 15th step speed frequency					
bit 12	1: Enable bit 06–11 function				
bit 14–13	00B: No function				
	01B: No function				
	10B: No function				
	11B: No function				
bit 15	Reserved				
Frequency command (XXX.XX Hz)		2001	48194	20001	
bit 0	1: E.F. (External Fault) ON	2002	48195	20002	
bit 1	1: Reset command				
bit 2	1: B.B. ON				
bit 4–3	Reserved				
bit 5	1: Enable fire mode				
bit 15–6	Reserved				
Status monitor read only	High byte: Warning code / Low Byte: Fault code	2100	48449	20400	

Content	Function	Hex	Dec	Octal	
Status monitor read only (continued)	bit 1-0	AC motor drive operation status 00B: The drive stops 01B: The drive is decelerating 10B: The drive is in standby status 11B: The drive is operating	2101	48450	20401
	bit 2	1: JOG command			
	bit 4-3	Operation direction 00B: FWD running 01B: From REV running to FWD running 10B: From FWD running to REV running 11B: REV running			
	bit 8	1: Master frequency controlled by the communication interface			
	bit 9	1: Master frequency controlled by the analog / external terminal signal			
	bit 10	1: Operation command controlled by the communication interface			
	bit 11	1: Parameter locked			
	bit 12	1: Enable to copy parameters from keypad			
	bit 15-13	Reserved			
	Frequency command (XXX.XX Hz)	2102	48451	20402	
	Output frequency (XXX.XX Hz)	2103	48452	20403	
	Display the drive's output current (XX.XX A). When the current is higher than 655.35, it automatically shifts one decimal place as (XXX.X A). Refer to the high byte of 211F for information on the decimal places.	2104	48453	20404	
	DC bus voltage (XXX.X V)	2105	48454	20405	
	Output voltage (XXX.X V)	2106	48455	20406	
	Current step for the multi-step speed operation	2107	48456	20407	
	Reserved	2108	48457	20410	
	Digital Input Counter value	2109	48458	20411	
	Output power factor angle (XXX.X)	210A	48459	20412	
	Output torque (XXX.X %)	210B	48460	20413	
	Actual motor speed (XXXXX rpm)	210C	48461	20414	
	Reserved	210D	48462	20415	
	Reserved	210E	48463	20416	
	Power output (X.XXX kW)	210F	48464	20417	
	Indicates one or decimal points for value in 210F.	2114	48469	20424	
	Multi-function display (P00.04)	2116	48471	20426	
	Maximum Operation Frequency (P01.00) or Maximum User-defined Value (P00.26) When P00.26 is 0, this value is equal to P01.00 setting When P00.26 is not 0, and the command source is keypad, this value = P00.24 * P00.26 / P01.00. When P00.26 is not 0, and the command source is 485, this value = P09.10 * P00.26 / P01.00.	211B	48476	20433	
	High byte: the decimal place of current value (display)	211F	48480	20437	
	Display the drive's output current (XX.XX A). When the current is higher than 655.35, it automatically shifts one decimal place as (XXX.X A). Refer to the high byte of 211F for information on the decimal places.	2200	48705	21000	
	Counter value	2201	48706	21001	
	Actual output frequency (XXXXX Hz)	2202	48707	21002	

Content	Function	Hex	Dec	Octal
Status monitor read only (continued)	DC bus voltage (XXX.X V)	2203	48708	21003
	Output voltage (XXX.X V)	2204	48709	21004
	Power factor angle (XXX.X)	2205	48710	21005
	Display the output power of U, V, W (XXXX.X kW)	2206	48711	21006
	Display the motor speed estimated by the drive or encoder feedback (XXXXX rpm)	2207	48712	21007
	Display the positive / negative output torque estimated by the drive (+0.0: positive torque; -0.0: negative torque) (XXX.X%)	2208	48713	21010
	Reserved	2209	48714	21011
	Display the PID feedback value after enabling PID function (XXX.XX%)	220A	48715	21012
	Display the AI1 analog input terminal signal, 0–10 V corresponds to 0.00–100.00% (see Explanation 1 in Pr.00-04)	220B	48716	21013
	Display the AI2 analog input terminal signal, 4–20 mA / 0–10 V corresponds to 0.00–100.00% (2.) (see Explanation 2 in P00.04)	220C	48717	21014
	Reserved	220D	48718	21015
	IGBT temperature of the power module (XXX.X °C)	220E	48719	21016
	Reserved	220F	48720	21017
	The digital input status (ON / OFF), refer to P02.12 (see Explanation 2 in P00.04)	2210	48721	21020
	The digital output status (ON / OFF), refer to P02.18 (see Explanation 3 in P00.04)	2211	48722	21021
	Current step for the multi-step speed operation	2212	48723	21022
	The corresponding CPU digital input pin status (d.) (see Explanation 3 in P00.04)	2213	48724	21023
	The corresponding CPU digital output pin status (O.) (see Explanation 4 in P00.04)	2214	48725	21024
	Reserved	2215	48726	21025
	Pulse input frequency (XXX.XX Hz)	2216	48727	21026
	Reserved	2217	48728	21027
	Reserved	2218	48729	21030
	Counter value of overload (XXX.XX %)	2219	48730	21031
	GFF (XXX.XX %)	221A	48731	21032
	DC bus voltage ripples (XXX.X V)	221B	48732	21033
	PLC register D1043 data	221C	48733	21034
	Magnetic field area of the synchronous motor	221D	48734	21035
	User page displays the value in physical measure	221E	48735	21036
	Output value of P00.05 (XXX.XX Hz)	221F	48736	21037
	Reserved	2220	48737	21040
	Reserved	2221	48738	21041
	Reserved	2222	48739	21042
	Control mode of the drive 0: speed mode 1: torque mode	2223	48740	21043
Carrier frequency of the drive (XX kHz)	2224	48741	21044	
Reserved	2225	48742	21045	

Content	Function	Hex	Dec	Octal	
Status monitor read only (continued)	Drive status	2226	48743	21046	
	bit 1–0				00b: No direction
					01b: Forward
					10b: Reverse
	bit 3–2				01b: Drive ready
					10b: Error
	bit 4				0b: Motor drive does not output
					1b: Motor drive outputs
	bit 5				0b: No warning
					1b: Warning
	Drive's estimated output torque (positive or negative direction) (XXXX N•m)	2227	48744	21047	
	Reserved	2228	48745	21050	
	KWH display (XXXX.X)	2229	48746	21051	
	Reserved	222A	48747	21052	
	Reserved	222B	48748	21053	
	Reserved	222C	48749	21054	
	Reserved	222D	48750	21055	
	PID target value (XXX.XX %)	222E	48751	21056	
	PID offset (XXX.XX %)	222F	48752	21057	
	PID output frequency (XXX.XX Hz)	2230	48753	21060	
	Reserved	2231	48754	21061	
	Display the auxiliary frequency	2232	48755	21062	
	Display the master frequency	2233	48756	21063	
Display the frequency after adding and subtracting of the master and auxiliary frequencies.	2234	48757	21064		

5) Exception response:

When the drive is using the communication connection, if an error occurs, the drive responds to the error code and sets the highest bit (bit 7) of the command code to 1 (function code AND 80H) then responds to the control system to signal that an error occurred.

If the keypad displays “CE-XX” as a warning message, “XX” is the error code at that time. Refer to the table of error codes for communication error for reference.

Example:

ASCII Mode	
STX	‘.’
Address	‘0’
	‘1’
Function	‘8’
	‘6’
Exception code	‘0’
	‘2’
LRC Check	‘7’
	‘7’
END	CR
	LF

RTU Mode	
Address	01H
Function	86H
Exception code	02H
CRC Check Low	C3H
CRC Check High	A1H

The following table describes the exception code.

Exception Code	Description
1	Function code is not supported or unrecognized.
2	Address is not supported or unrecognized.
3	Data is not correct or unrecognized.
4	Failure to execute this function code

P09.09	Communication Response Delay Time	Type	Hex Addr	Dec Addr
	<i>Range/Units (Format: 16-bit unsigned)</i>	◆R/W	0909	42314
	0.0–200.0 ms	<i>Default</i>		
		2.0		

If the host controller does not finish the transmitting/receiving process, you can use this parameter to set the response delay time after the AC motor drive receives communication command as shown in the following picture.

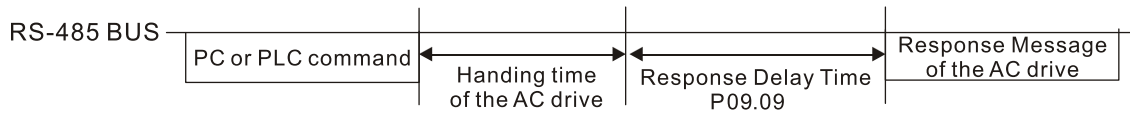

P09.10	Communication Main Frequency	Type	Hex Addr	Dec Addr
	<i>Range/Units (Format: 16-bit unsigned)</i>	R/W	090A	42315
	0.00–599.00 Hz	<i>Default</i>		
		60.00		

When you set P00.20 to 1 (RS-485 communication input), the AC motor drive saves the last Frequency command into P09.10 when there is abnormal power off or momentary power loss. When power is restored, the AC motor drive operates with the frequency in P09.10 if there is no new Frequency command input. When a Frequency command of 485 changes (the Frequency command source must be set as Modbus), this parameter also changes.

	Type	Hex Addr	Dec Addr
P09.11 <i>Block Transfer 1</i>	◆R/W	090B	42316
P09.12 <i>Block Transfer 2</i>	◆R/W	090C	42317
P09.13 <i>Block Transfer 3</i>	◆R/W	090D	42318
P09.14 <i>Block Transfer 4</i>	◆R/W	090E	42319
P09.15 <i>Block Transfer 5</i>	◆R/W	090F	42320
P09.16 <i>Block Transfer 6</i>	◆R/W	0910	42321
P09.17 <i>Block Transfer 7</i>	◆R/W	0911	42322
P09.18 <i>Block Transfer 8</i>	◆R/W	0912	42323
P09.19 <i>Block Transfer 9</i>	◆R/W	0913	42324
P09.20 <i>Block Transfer 10</i>	◆R/W	0914	42325
P09.21 <i>Block Transfer 11</i>	◆R/W	0915	42326
P09.22 <i>Block Transfer 12</i>	◆R/W	0916	42327
P09.23 <i>Block Transfer 13</i>	◆R/W	0917	42328
P09.24 <i>Block Transfer 14</i>	◆R/W	0918	42329
P09.25 <i>Block Transfer 15</i>	◆R/W	0919	42330
P09.26 <i>Block Transfer 16</i>	◆R/W	091A	42331
<i>Range/Units (Format: 16-bit unsigned)</i>	<i>Default</i>		
0–65535	0		

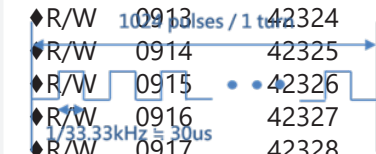

This is a group of block transfer parameters that is available for communications use in the drive (P09.11–P09.26). Using communication code 03H, you can store the parameters (P09.11–P09.26) that you want to read.

	Type	Hex Addr	Dec Addr
P09.30 <i>Communication Decoding Method</i>	R/W	091E	42335
<i>Range/Units (Format: 16-bit binary)</i>	<i>Default</i>		
0: Decoding method 1	0		
1: Decoding method 2			

Source of Operation Control	Decoding Method 1	Decoding Method 2
Digital Keypad	Digital keypad controls the drive action regardless of decoding method 1 or 2.	
External Terminal	External terminal controls the drive action regardless of decoding method 1 or 2.	
RS-485	Refer to address: 2000h–20FFh	Refer to address: 2000h–20FFh
Communication Card	Refer to address: 2000h–20FFh	Not supported - for future use
PLC	PLC command controls the drive action regardless of decoding method 1 or 2.	

Use Decoding Method 1. Decoding Method 2 is not supported at this time.

	Type	Hex Addr	Dec Addr
P09.33 <i>PLC Command Force to 0</i>	◆R/W	0921	42338
<i>Range/Units (Format: 16-bit unsigned)</i>	<i>Default</i>		
0–65535	0		

P09.33 defines whether the Frequency command or the Speed command must be cleared to zero or not before the PLC starts the next scan.

bit	Description
bit 0	Before PLC scan, set the PLC target frequency = 0
bit 1	Before PLC scan, set the PLC target torque = 0
bit 2	Before PLC scan, set the speed limit of torque mode = 0

	<i>Type</i>	<i>Hex Addr</i>	<i>Dec Addr</i>
P09.35 PLC Address	R/W	0923	42340
<i>Range/Units (Format: 16-bit unsigned)</i>	<i>Default</i>		
1–254	2		

The PLC address is required for modbus communications to the PLC. Ensure this address remains different from P09.00, or any other nodes on the modbus network. See Chapter 5 for more information.

	<i>Type</i>	<i>Hex Addr</i>	<i>Dec Addr</i>
P09.60 Communication Card Identification	Read	093C	42365
<i>Range/Units (Format: 16-bit binary)</i>	<i>Default</i>		
0: No communication card	0		
4: Modbus-TCP Slave			
5: EtherNet/IP Slave			
10: Backup Power Supply			

If P09.74 = 2, GS20A-CM-ENETIP comm card will identify as 4: Modbus TCP slave.

If P09.74 ≠ 2, GS20A-CM-ENETIP comm card will identify as 5:EtherNet/IP slave.

	<i>Type</i>	<i>Hex Addr</i>	<i>Dec Addr</i>
P09.61 Firmware Version of Communication Card	Read (Hex)	093D	42366
P09.62 Product Code	Read	093E	42367
P09.63 Error code	Read	093F	42368
<i>Range/Units (Format: 16-bit unsigned)</i>	<i>Default</i>		
Read only. P09.61 is displayed in Hex format.	0		

	<i>Type</i>	<i>Hex Addr</i>	<i>Dec Addr</i>
P09.74 Set Comm Master Protocol (for GS20A-CM-ENETIP)	◆R/W	094A	42379
<i>Range/Units (Format: 16-bit binary)</i>	<i>Default</i>		
0: Ethernet IP and MODBUS TCP both on	1		
1: EtherNet/IP			
2: Modbus TCP			

The GS20A-CM-ENETIP card is configurable to use Ethernet/IP and/or Modbus TCP communications. P09.74 defines the master protocol of the communication card and allows the user to define proper actions in the event of communication timeouts.

If P09.74 = 1: EtherNet/IP, in a timeout situation (defined by P09.93 – P09.95), only the EtherNet/IP connection (Implicit OR Explicit) will trigger the timeout, not Modbus TCP.

A ‘timeout situation’ is defined by 5 different possibilities:

- 1) A TCP RST or FIN message from the Master in EtherNet/IP Explicit (no EtherNet/IP Implicit).
- 2) A Forward Close message in EtherNet/IP Implicit.
- 3) No data message received in the time duration specified in Pr09-95 on EtherNet/IP Explicit.
- 4) No data message received in the time duration specified in RPI timeout EtherNet/IP Implicit.
- 5) Physical connection loss (no link available on Ethernet interface).

If P09.74 = 2: Modbus TCP, in a timeout situation (defined by P09.93 – P09.95), only the Modbus TCP connection will trigger the timeout, not EtherNet/IP Explicit (Implicit won’t be allowed in this case).

A ‘timeout situation’ is defined by 3 different possibilities:

- 1) A TCP RST or FIN message from the Master in Modbus TCP
- 2) No data message received in the time duration specified in Pr09-95 on Modbus TCP
- 3) Physical connection loss (no Link Good on Ethernet interface).

If P09.74 = 0: Ethernet/IP and Modbus TCP both on, a loss in either will cause a timeout.

	Type	Hex Addr	Dec Addr
P09.75 Communication Card IP Configuration (for GS20A-CM-ENETIP)	◆R/W	094B	42380
<i>Range/Units (Format: 16-bit binary)</i>	<i>Default</i>		
0: Static IP	0		
1: Dynamic IP (DHCP)			

When P09.75=0: Set the IP address manually.

When P09.75=1: IP address is dynamically set by the host controller.

	Type	Hex Addr	Dec Addr
P09.76 Communication Card IP Address 1 (for GS20A-CM-ENETIP)	◆R/W	094C	42381
P09.77 Communication Card IP Address 2 (for GS20A-CM-ENETIP)	◆R/W	094D	42382
P09.78 Communication Card IP Address 3 (for GS20A-CM-ENETIP)	◆R/W	094E	42383
P09.79 Communication Card IP Address 4 (for GS20A-CM-ENETIP)	◆R/W	094F	42384
<i>Range/Units (Format: 16-bit unsigned)</i>	<i>Default</i>		
0–255	0		

Use P09.76–P09.79 with a communication card.

	Type	Hex Addr	Dec Addr
P09.80 Communication Card Address Mask 1 (for GS20A-CM-ENETIP)	◆R/W	0950	42385
P09.81 Communication Card Address Mask 2 (for GS20A-CM-ENETIP)	◆R/W	0951	42386
P09.82 Communication Card Address Mask 3 (for GS20A-CM-ENETIP)	◆R/W	0952	42387
P09.83 Communication Card Address Mask 4 (for GS20A-CM-ENETIP)	◆R/W	0953	42388
P09.84 Communication Card Gateway Address 1 (for GS20A-CM-ENETIP)	◆R/W	0954	42389
P09.85 Communication Card Gateway Address 2 (for GS20A-CM-ENETIP)	◆R/W	0955	42390
P09.86 Communication Card Gateway Address 3 (for GS20A-CM-ENETIP)	◆R/W	0956	42391
P09.87 Communication Card Gateway Address 4 (for GS20A-CM-ENETIP)	◆R/W	0957	42392
<i>Range/Units (Format: 16-bit unsigned)</i>	<i>Default</i>		
0–255	0		

	Type	Hex Addr	Dec Addr
P09.88 Communication Card Password (Low Word)(for GS20A-CM-ENETIP)	◆R/W	0958	42393
P09.89 Communication Card Password (High Word)(for GS20A-CM-ENETIP)	◆R/W	0959	42394
<i>Range/Units (Format: 16-bit unsigned)</i>	<i>Default</i>		
0–99	0		

	Type	Hex Addr	Dec Addr
P09.90 Reset Communication Card (for GS20A-CM-ENETIP)	◆R/W	095A	42395
<i>Range/Units (Format: 16-bit binary)</i>	<i>Default</i>		
0: Disable	0		
1: Reset to defaults			

	<i>Type</i>	<i>Hex Addr</i>	<i>Dec Addr</i>
P09.91 Additional Settings for the Communication Card (for GS20A-CM-ENETIP)	◆ R/W	095B	42396
<i>Range/Units (Format: 16-bit binary)</i>	<i>Default</i>		
bit 0: Enable IP filter	0		
bit 1: Enable Internet parameters (1 bit) When the IP address is set, this bit is enabled. After updating the parameters for the communication card, this bit changes to disabled.			
bit 2: Enable login password (1 bit) When you enter the login password, this bit is enabled. After updating the communication card parameters, this bit changes to disabled.			

	<i>Type</i>	<i>Hex Addr</i>	<i>Dec Addr</i>
P09.92 Communication Card Status (for GS20A-CM-ENETIP)	R/W	095C	42397
<i>Range/Units (Format: 16-bit binary)</i>	<i>Default</i>		
bit 0: Enable password When the communication card is set with a password, this bit is enabled. When the password is cleared, this bit is disabled.	0		

	<i>Type</i>	<i>Hex Addr</i>	<i>Dec Addr</i>
P9.93 ENETIP Communication Card Fault Select (for GS20A-CM-ENETIP)	◆ R/W	095D	42398
<i>Range/Units (Format: 16-bit binary)</i>	<i>Default</i>		
0: Warn & Continue Operation	3		
1: Warn & Ramp to Stop			
2: Warn & Coast to Stop			
3: No Warning & Continue Operation			

This parameter is used to detect an Ethernet communication error and take appropriate action.

Related Parameters:

P09.74, P09.94, P09.95

	<i>Type</i>	<i>Hex Addr</i>	<i>Dec Addr</i>
P9.94 ENETIP Communication Card Time Out Detection (for GS20A-CM-ENETIP)	◆ R/W	095E	42399
<i>Range/Units (Format: 16-bit binary)</i>	<i>Default</i>		
0: Disable	0		
1: Enable			

This parameter Enables or Disables time-out detection for Ethernet communications.

Related Parameters:

P09.74, P09.93, P09.95

		Type	Hex Addr	Dec Addr
P9.95	ENETIP Communication Card Time Out Duration (for GS20A-CM-ENETIP)	◆ R/W	095F	42400
	<i>Range/Units (Format: 16-bit unsigned)</i>	<i>Default</i>		
	0.1 to 100.0 seconds	0.5		

When parameter P9.94 is set to 1, the communications Time Out Detection is Enabled. If a delay in communications for more than the Time Out Duration (P9.95) is detected, the action selected by the Transmission Fault Treatment (P9.93) will be used.

Related Parameters:

P09.74, P09.93, P09.94

GROUP P10.xx DETAILS – SPEED FEEDBACK CONTROL PARAMETERS

In this parameter group the following abbreviations are used:

- ASR - Adjust Speed Regulator
- AMR - Active Magnetic Regulator
- PG - Pulse Generator

Parameters P10.00 - P10.21 are used for setting up a pulse generator signal into the GS20(X) drive. The DI7 multifunction input will accept a pulse generator signal with a maximum frequency of 33kHz. This signal can be configured as an encoder feedback device from a motor (PG) or as a speed command signal to the drive (PG2) from another device.

DI7 (PG) uses pulse time to calculate the motor frequency. The Encoder PPR (pulse per revolution) and Motor RPM will affect the operating frequency range. Normal encoder PPR values are 512, 1024, 2048, etc. To calculate the operating frequency of an application, use this formula:

$$(\text{Max Motor RPM} \times \text{Encoder PPR}) / 60 \text{ seconds} = \text{Pulses/Sec}$$

Choose an encoder PPR value that will generate less than 33,000 pulses/sec for use with the DI7 input.



NOTE: For GS20, VF+PG is only single-phase input and will not know if it's REV or FWD.

The following table summarizes the parameter configuration for the PG and PG2 application. See the detailed parameter descriptions for more information.

Parameter	Pulse Generator (PG) (Use for Motor Encoder Feedback)	Pulse Generator 2 (PG2) (Use for Pulse Input Frequency Reference)	Description
	Parameter Setting		
P00.04	--	22	View Input Frequency value on keypad display (optional)
P00.11	1	--	Speed Control Mode (IMVFPG mode only)
P00.20	--	4	Auto Mode Only
P00.30	--	4	Manual Mode Only
P02.07	0	0	DI7 input config
P03.20	--	19	Analog Output to send PG2 signal to another device (optional)
P10.00	5	5	Selects Pulse Input for use
P10.01	PPR	PPR	Defines Pulses per revolution of device
P10.02	5	0	Encoder input type (PG only)
P10.04	1-65535	--	Electrical Gearing Load Side A1 (PG)
P10.05	1-65535	--	Electrical Gearing Motor Side B1 (PG)
P10.06	1-65535	--	Electrical Gearing Load Side A2 (PG)
P10.07	1-65535	--	Electrical Gearing Motor Side B2 (PG)
P10.10	0-120%	--	Encoder Stall Level (PG)
P10.11	0-2.0 sec	--	Encoder Stall Time (PG)
P10.12	0, 1, or 2	--	Encoder Stall Action (PG)
P10.13	0-50%	--	Encoder Slip Range (PG)
P10.14	0-10 sec	--	Encoder Slip Detection Time (PG)
P10.15	0, 1, or 2	--	Encoder Stall and Slip Error Action (PG)
P10.16	0	5	Set PG2 Pulse Input Type
P10.17	--	1-65535	PG2 Electrical Gear A
P10.18	--	1-65535	PG2 Electrical Gear B
P10.21	--	1-65535 sec	PG2 Low Pass Filter Time

P10.00 Encoder Type Selection	Type	Hex Addr	Dec Addr
	R/W	0A00	42561
<i>Range/Units (Format: 16-bit binary)</i>	<i>Default</i>		
0: Disabled	0		
5: Pulse input (DI7)			

When you use DI7 single-phase pulse input (PG2), you must use it with P10.00=5 and P00.20=4, P02.07=0, and P10.16=5.

When you use DI7 single-phase pulse input as speed feedback (PG), you must use it with P02.07=0, P10.00=5, and P10.02=5. The drive calculates the DI7 single-phase pulse input speed when the control mode is IMVFPG.

The GS20(X) does not support the full position control pulse command input function.

P10.01 Encoder Pulses per Revolution	Type	Hex Addr	Dec Addr
	R/W	0A01	42562
<i>Range/Units (Format: 16-bit unsigned)</i>	<i>Default</i>		
1–20000	600		

P10.01 sets the encoder pulses per revolution (PPR). It is a feedback control signal source when using PG (pulse generator) for DI7. The encoder sets the number of pulses for the motor rotating through one rotation. The A/B phase cycle generates the pulse number.

- This setting is also the encoder resolution. The speed control is more accurate with higher resolution.
- If you set this parameter incorrectly, it may cause motor stall, drive over-current, or a magnetic pole origin detection error for the PM motor in closed-loop control. When using the PM motor, you must perform the magnetic pole origin detection (P05.00 = 13) again if you modify the content of this parameter.

P10.02 Encoder Input Type Setting (PG)	Type	Hex Addr	Dec Addr
	R/W	0A02	42563
<i>Range/Units (Format: 16-bit binary)</i>	<i>Default</i>		
0: Disable	0		
5: Single-phase input (DI7)			

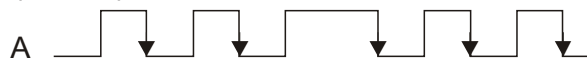

P10.02 sets the DI7 Pulse input as an encoder feedback device from the motor (PG).

To use this parameter, P10.00=5 and P10.16=0 are required.

P10.04 Electrical Gear at Load Side A1	Type	Hex Addr	Dec Addr
	◆R/W	0A04	42565
P10.05 Electrical Gear at Motor Side B1	◆R/W	0A05	42566
P10.06 Electrical Gear at Load Side A2	◆R/W	0A06	42567
P10.07 Electrical Gear at Motor Side B2	◆R/W	0A07	42568
<i>Range/Units (Format: 16-bit unsigned)</i>	<i>Default</i>		
1–65535	100		

Use P10.04–P10.07 with the multi-function input terminal setting 48 to switch to P10.04– P10.05 or P10.06–P10.07, as shown in the diagram below.

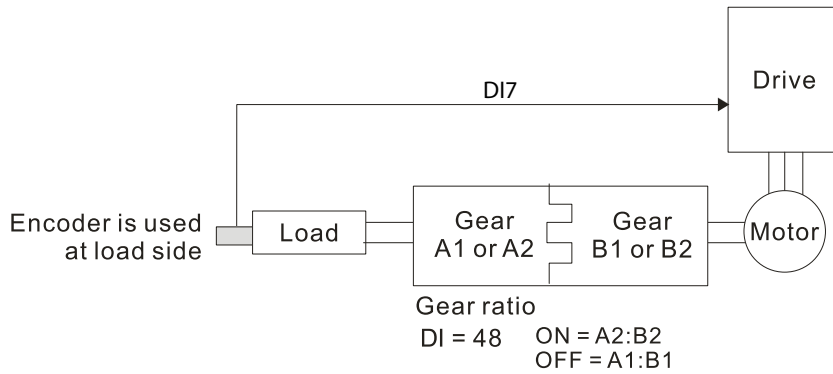

	Type	Hex Addr	Dec Addr
P10.10 Encoder Stall Level	◆R/W	0A0A	42571
<i>Range/Units (Format: 16-bit unsigned)</i>	<i>Default</i>		
0–120% (0: Disable)	115		

P10.10 determines the maximum encoder feedback signal allowed before a fault occurs; the maximum operation frequency P01.00 = 100%.

	Type	Hex Addr	Dec Addr
P10.11 Detection Time of Encoder Stall	◆R/W	0A0B	42572
<i>Range/Units (Format: 16-bit unsigned)</i>	<i>Default</i>		
0.0–2.0 sec.	0.1		

	Type	Hex Addr	Dec Addr
P10.12 Encoder Stall Action	◆R/W	0A0C	42573
<i>Range/Units (Format: 16-bit binary)</i>	<i>Default</i>		
0: Warn and continue operation	2		
1: Fault and ramp to stop			
2: Fault and coast to stop			

When the drive output frequency exceeds the encoder stall level (P10.10), the drive starts to count the time. When the error time exceeds the encoder stall detection time (P10.11), the drive implements the encoder stall action.

	Type	Hex Addr	Dec Addr
P10.13 Encoder Slip Range	◆R/W	0A0D	42574
<i>Range/Units (Format: 16-bit unsigned)</i>	<i>Default</i>		
0–50% (0: Disable)	50		

	Type	Hex Addr	Dec Addr
P10.14 Detection Time of Encoder Slip	◆R/W	0A0E	42575
<i>Range/Units (Format: 16-bit unsigned)</i>	<i>Default</i>		
0.0–10.0 sec.	0.5		

	Type	Hex Addr	Dec Addr
P10.15 Encoder Stall and Slip Error Action	◆R/W	0A0F	42576
<i>Range/Units (Format: 16-bit binary)</i>	<i>Default</i>		
0: Warn and continue operation	2		
1: Fault and ramp to stop			
2: Fault and coast to stop			

P10.15 acts on the settings for P10.13–P10.14:

When the value of (rotation speed – motor frequency) exceeds the P10.13 setting, and the detection time exceeds P10.14; the drive starts to count the time. If the detection time exceeds P10.14, the encoder feedback signal error occurs.

	Type	Hex Addr	Dec Addr
P10.16 Pulse Input Type Setting (PG2)	◆R/W	0A10	42577
<i>Range/Units (Format: 16-bit binary)</i>	<i>Default</i>		
0: Disabled	0		
5: Single-phase input (DI7)			

P10.16 sets the DI7 Pulse input as a pulse generator input for frequency reference (PG2).

When P10.16=5, you cannot set P10.02 to 5: Single-phase input (DI7) for closed-loop control.

The setting steps when using the DI7 single-phase pulse input as the frequency command:

- 1) Set P00.20=4: Pulse input without direction command
- 2) Set P02.07=0
- 3) Set P10.00=5: Pulse input (DI7)
- 4) Set P10.01 to motor pulses per revolution (PPR)
- 5) Set P10.16=5: Single-phase input (DI7)
- 6) Set P00.04=22 (Pulse input frequency) to verify if the pulse input frequency is correct.

	Type	Hex Addr	Dec Addr
P10.17 PG2 Electrical Gear A	◆R/W	0A11	42578
P10.18 PG2 Electrical Gear B	◆R/W	0A12	42579
<i>Range/Units (Format: 16-bit unsigned)</i>	<i>Default</i>		
1–65535	100		

Rotation speed = pulse frequency / encoder pulses (P10.01) * electrical gear A / electrical gear B.

	Type	Hex Addr	Dec Addr
P10.21 PG2 Pulse Input Speed Command Low Pass Filter Time	◆R/W	0A15	42582
<i>Range/Units (Format: 16-bit binary)</i>	<i>Default</i>		
0.000–65.535 sec.	0.100		

When you set P00.20 to 4, the system treats the pulse command as a Frequency command. Use this parameter to suppress the speed command jump.

Parameters P10.24 - P10.53 are for configuring the speed and torque control loop characteristics. These parameters are only applicable to certain speed control modes (P00.11). See function block diagrams under P00.11 on page 4–59 for a visual representation of how the parameters interact.

P10.24 FOC Function Control	<i>Type</i>	<i>Hex Addr</i>	<i>Dec Addr</i>
	◆R/W	0A18	42585
	<i>Default</i>	0	
<i>Range/Units (Format: 16-bit unsigned)</i>			
0–65535			

FOC (Field Oriented Control) is the highest accuracy speed control mode of the drive, set by P00.11=5: IMFOC sensorless mode. This parameter configures the optional settings of FOC.

bit	Description
0	ASR controller under torque control. 0: use PI as ASR; 1: use P as ASR
1–10	N/A
11	Activates the DC brake when executing the zero torque command. 0: ON; 1: OFF
12	FOC sensorless mode with crossing zero means the speed goes from negative to positive or positive to negative (forward to reverse direction or reverse to forward direction). 0: determined by the stator frequency; 1: determined by the speed command
13	N/A
14	N/A
15	Direction control in open-loop torque 0: Switch ON direction control; 1: Switch OFF direction control

Only bit = 0 is used for closed-loop; other bits are used for open-loop.

Set the bits as needed in binary format. Then convert to decimal for parameter entry on drive keypad, or Hex for parameter entry on optional GS4-KPD.

This parameter is only active when P00.11=5: IMFOC sensorless mode. See function block diagrams under P00.11 on page 4–59.

P10.25 FOC Bandwidth for Speed Observer	<i>Type</i>	<i>Hex Addr</i>	<i>Dec Addr</i>
	◆R/W	0A19	42586
	<i>Default</i>	40.0	
<i>Range/Units (Format: 16-bit unsigned)</i>			
20.0–100.0 Hz			

Setting the speed observer to a higher bandwidth could shorten the speed response time but creates greater noise interference during the speed observation.

This parameter is only active when P00.11=5: IMFOC Sensorless mode. See Function diagram under P00.11 on page 4–59.

P10.26 FOC Minimum Stator Frequency	<i>Type</i>	<i>Hex Addr</i>	<i>Dec Addr</i>
	◆R/W	0A1A	42587
	<i>Default</i>	2.0	
<i>Range/Units (Format: 16-bit unsigned)</i>			
0.0–10.0% fN			

P10.26 sets the stator frequency lower limit in operation status. This setting ensures the stability and accuracy of observer and avoids interferences from voltage, current and motor parameters. fN is the motor rated frequency.

This parameter is only active when P00.11=5: IMFOC Sensorless mode. See Function diagram under P00.11 on page 4–59.

	Type	Hex Addr	Dec Addr
P10.27 FOC Low Pass Filter Time Constant	◆R/W	0A1B	42588
<i>Range/Units (Format: 16-bit unsigned)</i>	<i>Default</i>		
1–1000 ms	50		

P10.27 sets the low pass filter time constant of a flux observer at start-up. If you cannot activate the motor during high speed operation, lower the setting for this parameter.

	Type	Hex Addr	Dec Addr
P10.28 FOC Gain for Excitation Current Rise Time	◆R/W	0A1C	42589
<i>Range/Units (Format: 16-bit unsigned)</i>	<i>Default</i>		
33–100% Tr	100		

P10.28 sets the drive’s excitation current rise time when it activates in open-loop torque mode. When the drive’s activation time is too long in torque mode, adjust this parameter to a shorter time value. Tr is the rotor time constant.

	Type	Hex Addr	Dec Addr
P10.29 Upper Limit of Frequency Deviation	◆R/W	0A1D	42590
<i>Range/Units (Format: 16-bit unsigned)</i>	<i>Default</i>		
0.00–200.00 Hz	20.00		

P10.29 limits the maximum frequency deviation.

This parameter is only applicable when P00.11=IMVFPG, using input DI7 as the PG (encoder).

If you set this parameter too high, an abnormal feedback malfunction occurs.

If the application needs a higher setting for P10.29, note that a higher setting results in larger motor slip, which causes a PG Error (PGF3, PGF4). In this case, you can set P10.10 and P10.13 to 0 to disable PGF3 and PGF4 detection, but you must make sure the DI7 wiring and application are correct; otherwise, it may lose the instant PG protection. Setting P10.29 too high is not commonly done.

	Type	Hex Addr	Dec Addr
P10.31 I/F Mode, Current Command	◆R/W	0A1F	42592
<i>Range/Units (Format: 16-bit unsigned)</i>	<i>Default</i>		
0–150% rated current of the motor	40		

P10.31 is only applicable to PM motors with P00.11= 2: PMSVC. See Function diagram under P00.11 on page 4–59.

P10.31 sets the current command for the drive in the low speed area (low speed area: Frequency command < P10.39). When the motor stalls on heavy duty start-up or forward/reverse with load, increase the parameter value. If the inrush current is too high and causes oc stall, then decrease the parameter value.

	Type	Hex Addr	Dec Addr
P10.32 PM Sensorless Speed Estimator Bandwidth	◆R/W	0A20	42593
<i>Range/Units (Format: 16-bit unsigned)</i>	<i>Default</i>		
0.00–600.00 Hz	5.00		

P10.32 is only applicable to PM motors with P00.11= 2: PMSVC. See Function diagram under P00.11 on page 4–59.

P10.32 sets the speed estimator bandwidth. Adjust the parameter to influence the stability and the accuracy of the motor speed.

If there is low frequency vibration (the waveform is similar to a sine wave) during the process, then increase the bandwidth. If there is high frequency vibration (the waveform shows extreme vibration and is like a spur), then decrease the bandwidth.

	<u>Type</u>	<u>Hex Addr</u>	<u>Dec Addr</u>
P10.34 PM Sensorless Speed Estimator Low-pass Filter Gain	◆R/W	0A22	42595
<u>Range/Units (Format: 16-bit unsigned)</u>	<u>Default</u>		
0.00–655.35	1.00		

P10.34 is only applicable to PM motors with P00.11= 2: PMSVC. See Function diagram under P00.11 on page 4–59.

P10.34 influences the response speed of the speed estimator.

If there is low frequency vibration (the waveform is similar to a sine wave) during the process, then increase the gain. If there is high frequency vibration (the waveform shows extreme vibration and is like a spur), then decrease the gain.

	<u>Type</u>	<u>Hex Addr</u>	<u>Dec Addr</u>
P10.35 AMR (Kp) Gain	◆R/W	0A23	42596
<u>Range/Units (Format: 16-bit unsigned)</u>	<u>Default</u>		
0.00–3.00	1.00		

	<u>Type</u>	<u>Hex Addr</u>	<u>Dec Addr</u>
P10.36 AMR (Ki) Gain	◆R/W	0A24	42597
<u>Range/Units (Format: 16-bit unsigned)</u>	<u>Default</u>		
0.00–3.00	0.20		

The AMR parameters P10.35 and P10.36 are only active when P00.11= 5: IMFOC Sensorless mode. See Function diagram under P00.11 on page 4–59.

Active Magnetic Regulator (AMR) Kp/Ki, affects the response of magnetic regulation in the low magnetic area.

If entering the low magnetic area and the input voltage (or DC BUS) plummets (e.g. an unstable power net causes instant insufficient voltage, or a sudden load that makes DC BUS drop), which causes the ACR diverge and oc, then increase the gain. If the Id value of a spur creates large noise in high-frequency output current, decrease the gain to reduce noise. Decreasing the gain will slow down the response.

	<u>Type</u>	<u>Hex Addr</u>	<u>Dec Addr</u>
P10.39 Frequency Point to Switch from I/F Mode to PM Sensorless Mode	◆R/W	0A27	42600
<u>Range/Units (Format: 16-bit unsigned)</u>	<u>Default</u>		
0.00–599.00 Hz	20.00		

P10.39 sets the frequency for the switch point from low frequency to high frequency. This parameter is only applicable to PM motors with P00.11=2: PMSVC.

Due to the weak back-EMF in the low frequency area, PM sensorless mode cannot estimate the accurate speed and position of the rotor. Thus, using I/F mode control is more suitable. In the medium-to-high frequency area, PM sensorless can accurately estimate the back-EMF, stabilizes and controls the motor with lower current.

If the switch point is too low and PM sensorless mode operates at a too low frequency, the motor does not generate enough back-EMF to let the speed estimator measure the right position and speed of the rotor, and causes stall and oc when running at the switch point frequency.

If the switch point is too high, the drive easily runs in the frequency area of the I/F mode for a long time, which generates a larger current and will not save energy. (If the current for P10.31 is too high, the high switch point makes the drive continue to output with the setting value for P10.31.)

	Type	Hex Addr	Dec Addr
P10.42 Initial Angle Detection Pulse Value	◆R/W	0A2A	42603
<u>Range/Units (Format: 16-bit unsigned)</u>	<u>Default</u>		
0.0–3.0	1.0		

P10.42 is only applicable to SPM motors with P00.11=2:PMSVC. See Function diagram under P00.11 on page 4–59.

P10.42 is only active when P10.53=3:Pulse Injection.

The angle detection is fixed to 3: Use the pulse injection method to start. The parameter influences the value of the pulse during the angle detection. The larger the pulse, the higher the accuracy of rotor’s position. A larger pulse might cause oc.

Increase the parameter when the running direction and the command are opposite during start-up. If oc occurs at start-up, then decrease the parameter.

Refer to Adjustment & Application for detailed motor adjustment procedure.

	Type	Hex Addr	Dec Addr
P10.49 Zero Voltage Time during Start-up	◆R/W	0A31	42610
<u>Range/Units (Format: 16-bit unsigned)</u>	<u>Default</u>		
0.000–60.000 sec.	0.000		

P10.49 is valid only when the setting of P07.12 (Speed Tracking during Start-up) = 0.

When the motor is in static state at start-up, this increases the accuracy when estimating angles. In order to put the motor in static state, set the drive three-phase output to the motor to 0V. The P10.49 setting time is the length of time for three-phase output at 0 V.

It is possible that even when you apply this parameter, the motor cannot go in to the static state because of inertia or some external force. If the motor does not go into a complete static state in 0.2 seconds, increase this setting value appropriately.

If P10.49 is set too high, the start-up time is longer. If it is too low, then the braking performance is weak.

	Type	Hex Addr	Dec Addr
P10.51 Injection Frequency	◆R/W	0A33	42612
<u>Range/Units (Format: 16-bit unsigned)</u>	<u>Default</u>		
0–1200 Hz	500		

P10.51 is a high frequency injection command in PM SVC control mode, and usually you do not need to adjust it. But if a motor’s rated frequency (for example, 400Hz) is too close to the frequency setting for this parameter (that is, the default of 500Hz), it affects the accuracy of the angle detection. Refer to the setting for P01.01 before you adjust this parameter.

- If the setting value for P00.17 is lower than $P10.51 \times 10$, then increase the frequency of the carrier frequency.
- P10.51 is valid only when P10.53 = 2.

	Type	Hex Addr	Dec Addr
P10.52 Injection Magnitude	◆R/W	0A34	42613
<u>Range/Units (Format: 16-bit unsigned)</u>	<u>Default</u>		
120V / 230V series: 100.0 V	15.0 / 30.0 / 37.5		
460V series: 200.0 V			
575V series: 200.0 V			

Note: The setting range varies depending on the voltage.

P10.52 is the magnitude command for the high frequency injection signal in PM SVC control mode.

Increasing the parameter can increase the accuracy of the angle estimation, but the electromagnetic noise might be louder if the setting value is too high.

- The system uses this parameter when the motor's parameter is "Auto". This parameter influences the angle estimation accuracy.
- When the ratio of the salient pole (Lq / Ld) is lower, increase P10.52 to make the angle detection accurate.
- P10.52 is valid only when P10.53 = 2.

	Type	Hex Addr	Dec Addr
P10.53 Angle Detection Method	◆R/W	0A35	42614
<i>Range/Units (Format: 16-bit binary)</i>	<i>Default</i>		
0: Disabled	0		
1: Force attracting the rotor to zero degrees			
2: High frequency injection			
3: Pulse injection			

Set P10.53 = 2 for IPM; set to 3 for SPM. If these settings cause problems, then set the parameter to 1.

GROUP P11.xx DETAILS – ADVANCED PARAMETERS

In this parameter group the following abbreviations are used:

- *ASR* - Adjustable Speed Regulation. ASR parameters are for tuning the zero, low and high speed ranges of the drive when in IMFOC sensorless vector speed control mode (P00.11=5) or IMVFPG (P00.11=1) speed control mode.

Parameters P11.00 – P11.16 are used to configure the Adjust Speed Regulator.

Parameters P11.17 – P11.38 are used to configure Torque control parameters.

	Type	Hex Addr	Dec Addr
P11.00 Adjust Speed Regulator (ASR) System Control	R/W	0B00	42817
<i>Range/Units (Format: 16-bit binary)</i>	<i>Default</i>		
bit 0: Auto-tuning for ASR	0		
bit 3: Dead time compensation closed			
bit 7: Save or do not save the frequency			

When P11.00 Bit 0=0, parameters P11.06 – P11.11 are enabled (applicable to P00.11 = 1: IMVFPG or 5: IMFOC sensorless modes).

When P11.00 Bit 0=1, Auto-tuning mode enables parameters 11.03 – 11.05. P11.12 – ASR Speed feed forward and P11.13- PDFF Gain are also enabled (applicable to P00.11 = 5: IMFOC sensorless only).

When P11.00 bit 7 = 0: Save the frequency before power is OFF. When power is ON again, the saved frequency is displayed.

When P11.00 bit 7 = 1: The frequency is not saved when power is cycled OFF. When power is cycled ON again, 0.00 Hz is the displayed frequency.

See Function diagram under P00.11 on page 4–59.

	Type	Hex Addr	Dec Addr
P11.01 ASR Per-Unit of System Inertia	R/W	0B01	42818
<i>Range/Units (Format: 16-bit unsigned)</i>	<i>Default</i>		
1–65535 (256 = 1 PU)	256		

To get the system inertia per unit from P11.01, you need to set P11.00 to bit1 = 1 and execute continuous forward / reverse running. See Adjustments and Applications section.

When P11.01 = 256, it is 1PU. So if you use a 2HP motor, the 2HP motor inertia is 0.00043 kg-cm² according to the table below. If P11.01 = 10000 after tuning, the system inertia is (10000 / 256) x 0.00043 kg-cm².

Perform the operation test with load based on the inertia after tuning. Run the motor in acceleration, deceleration, and steady speed and observe the values. If values between speed feedback and speed command are close, steady-state error is small and overshoot is less, then this inertia is a better one.

If the Iq current command from ASR has a high-frequency glitch, then decrease the setting. If the response time of sudden loading is too slow, then increase the setting.

When using torque mode as the control mode, perform the tuning with speed mode first to see if the tuned inertia can work normally. After verifying with speed mode, change the control mode to torque mode.

The following table shows the base value for the induction motor system inertia (Unit: kg-m²)

Power	Setting	Power	Setting
1 HP	0.00023	10 HP	0.00358
2 HP	0.00043	15 HP	0.00743
3 HP	0.00083	20 HP	0.00953
5 HP	0.00148	25 HP	0.01428
7.5 HP	0.0026	30 HP	0.01765

	Type	Hex Addr	Dec Addr
P11.02 ASR1 / ASR2 Switch Frequency	◆R/W	0B02	42819
<i>Range/Units (Format: 16-bit unsigned)</i>	<i>Default</i>		
5.00–599.00 Hz	7.00		

P11.02 sets the low-speed and high-speed ASR switching point in the FOC area. Provides flexibility to meet two needs: in the high-speed region of the estimator switch point it has a high response, and in the low-speed region of the estimator switch point it has a lower response. The recommended switching point is higher than P10.39.

A low setting does not cover P10.39. If the setting is too high, high-speed range is too narrow.

	Type	Hex Addr	Dec Addr
P11.03 ASR1 Low-speed Bandwidth	◆R/W	0B03	42820
P11.04 ASR2 High-speed Bandwidth	◆R/W	0B04	42821
P11.05 Zero-speed Bandwidth	◆R/W	0B05	42822
<i>Range/Units (Format: 16-bit unsigned)</i>	<i>Default</i>		
1–40 Hz	10		

After estimating the inertia and setting P11.00 bit 0 = 1 (auto-tuning), you can adjust P11.03, P11.04 and P11.05 separately by speed response. The larger the setting value, the faster the response. P11.02 is the switch frequency between the low-speed/high-speed bandwidth.

	Type	Hex Addr	Dec Addr
P11.06 ASR 1 Gain	◆R/W	0B06	42823
P11.08 ASR2 Gain	◆R/W	0B08	42825
P11.10 ASR Gain of Zero Speed	◆R/W	0B0A	42827
<i>Range/Units (Format: 16-bit unsigned)</i>	<i>Default</i>		
0–40 Hz	10		

Enabled when P11.00 Bit 0 = 0.

	Type	Hex Addr	Dec Addr
P11.07 ASR 1 Integral Time	◆R/W	0B07	42824
P11.09 ASR2 Integral Time	◆R/W	0B09	42826
P11.11 ASR Integral Time of Zero Speed	◆R/W	0B0B	42828
<i>Range/Units (Format: 16-bit unsigned)</i>	<i>Default</i>		
0.000–10.000 sec.	0.100		

Enabled when P11.00 Bit 0 = 0.

P11.12 Gain for ASR Speed Feed Forward

Range/Units (Format: 16-bit unsigned)

0–200%

Type Hex Addr Dec Addr

◆R/W 0B0C 42829

Default

0

This function enables when P11.00 bit 0 = 1.

Increase the setting for P11.12 to reduce the command tracking difference and improve the speed response. Use this function for speed tracking applications.

Set P11.01 correctly to improve the speed response.

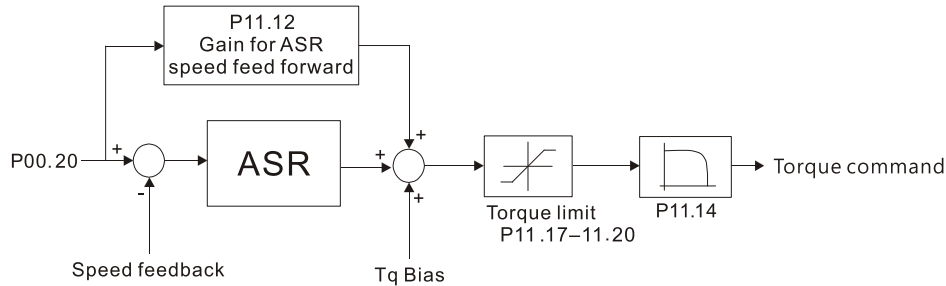

P11.13 PDFF Gain Value

Range/Units (Format: 16-bit unsigned)

0–200%

Type Hex Addr Dec Addr

◆R/W 0B0D 42830

Default

30

P11.13 is invalid when P05.24 = 1. This parameter is valid only when P11.00 bit0 = 1.

After you estimate and set P11.00 bit0=1 (auto-tuning), use P11.13 to reduce overshoot. However, a shift of the curve may occur earlier. In this case, you can set P11.13=0 first, and then increase the setting value to "a condition with best acceleration and without overshoot" when the acceleration time meets your application but overshoot occurs.

- Increasing P11.13 improves the overshoot of speed tracking, but an excessive value may reduce the transient response.
- Increasing P11.13 enhances the system stiffness in high-speed steady state and reduces the speed transient fluctuation at a sudden loading.

Set P11.01 system inertia correctly to improve speed response.

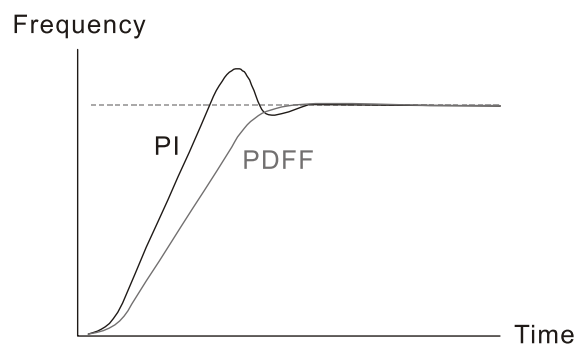

P11.14 ASR Output Low Pass Filter Time

Range/Units (Format: 16-bit unsigned)

0.000–0.350 sec.

Type Hex Addr Dec Addr

◆R/W 0B0E 42831

Default

0.008

P11.14 sets the ASR command filter time.

	Type	Hex Addr	Dec Addr
P11.15 Notch Filter Depth	◆R/W	0B0F	42832
<i>Range/Units (Format: 16-bit unsigned)</i>	<i>Default</i>		
0–20 db	0		

	Type	Hex Addr	Dec Addr
P11.16 Notch Filter Frequency	◆R/W	0B10	42833
<i>Range/Units (Format: 16-bit unsigned)</i>	<i>Default</i>		
0.00–200.00 Hz	0.00		

P11.16 sets the resonance frequency of the mechanical system. Adjust it to a smaller value to suppress the mechanical system resonance.

- A larger value improves resonance suppression function.
- The notch filter frequency is the mechanical frequency resonance.

	Type	Hex Addr	Dec Addr
P11.17 Forward Motor Torque Limit	◆R/W	0B11	42834
P11.18 Forward Regenerative Torque Limit	◆R/W	0B12	42835
P11.19 Reverse Motor Torque Limit	◆R/W	0B13	42836
P11.20 Reverse Regenerative Torque Limit	◆R/W	0B14	42837
<i>Range/Units (Format: 16-bit unsigned)</i>	<i>Default</i>		
0–500%	500		

FOC Sensorless mode:

The motor rated current = 100%. The settings for P11.17–P11.20 compare with the P03.00=7, 8, 9, 10. The minimum value of the comparison result is the torque limit. The diagram below illustrates the torque limit.

TQC sensorless mode:

The function of P11.17–P11.20 is the same as FOC; however, in this case, the torque limit and the torque command executes the output torque limit at the same time. Therefore, the minimum value between P11.17–P11.20 and P06.12 becomes the current output torque limit.

Calculation equation for the motor rated torque:

$$\text{Motor rated torque: } T(N.M) = \frac{P(W)}{\omega(rad / s)}$$

$$P (W) \text{ value} = P05.02, \omega (rad / s) \text{ value} = P05.03; \frac{P5.03 \times 2\pi}{60} = rad / s$$

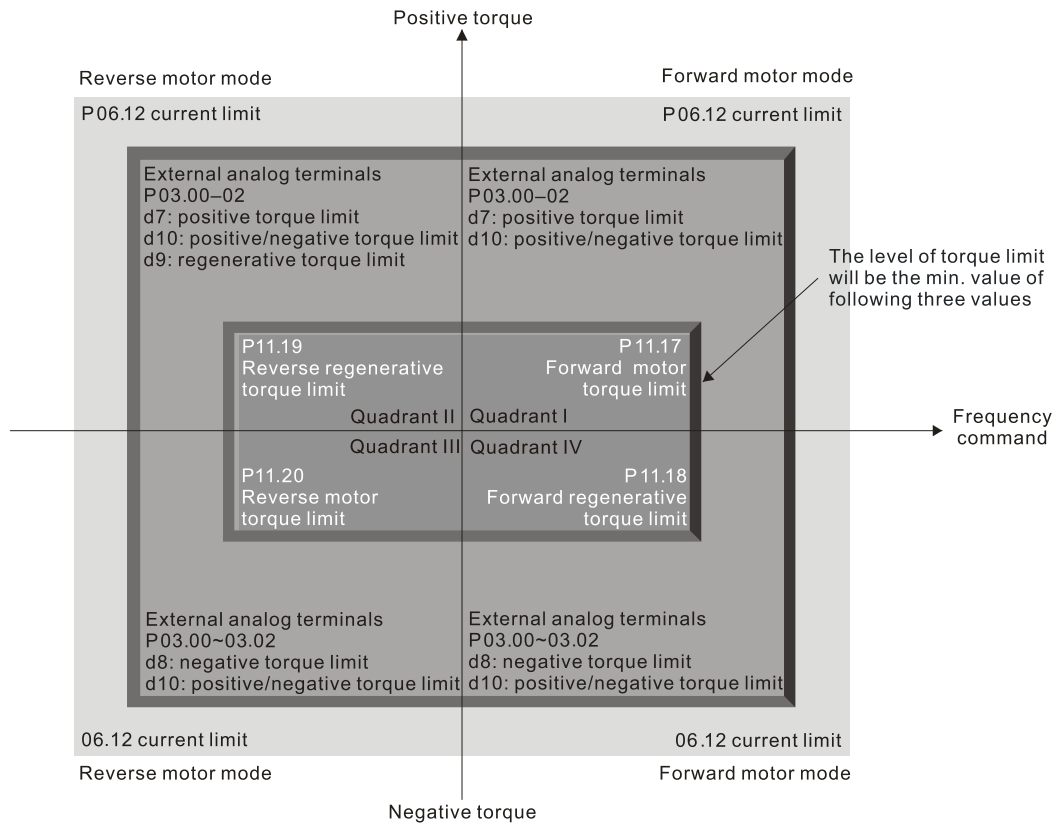

Note: P11.21-P11.38 are for configuring Torque control mode (IM TQC Sensorless, P00.10=2). See Function block diagram under P00.11 on page 4-59 and Adjustments and Applications section.

	Type	Hex Addr	Dec Addr
P11.21 Flux Weakening Curve for Motor 1 Gain Value	◆R/W	0B15	42838
P11.22 Flux Weakening Curve for Motor 2 Gain Value	◆R/W	0B16	42839
<i>Range/Units (Format: 16-bit unsigned)</i>	<i>Default</i>		
0–200%	90		

P11.21 and P11.22 adjust the output voltage for the flux weakening curve.

For the spindle application, use this adjustment method:

- 1) Run the motor to the highest frequency.
- 2) Observe the output voltage.
- 3) Adjust P11.21 (motor 1) or P11.22 (motor 2) setting to make the output voltage reach the motor rated voltage.
- 4) The larger the setting value, the greater the output voltage.

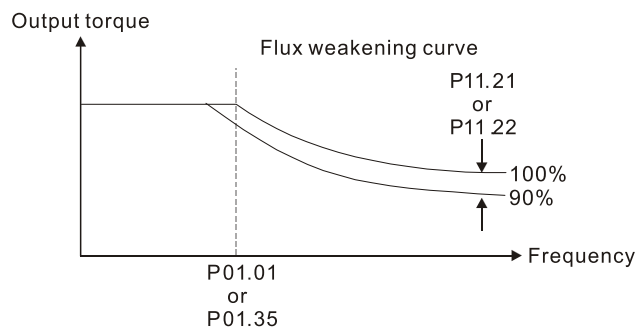

P11.23	Flux Weakening Area Speed Response	Type	Hex Addr	Dec Addr
		◆R/W	0B17	42840
	<i>Range/Units (Format: 16-bit unsigned)</i>	<i>Default</i>		
	0–150%	65		

P11.23 controls the speed in the flux weakening area. The larger the value, the faster the acceleration/deceleration. In normal condition, you do not need to adjust this parameter.

P11.27	Maximum Torque Command	Type	Hex Addr	Dec Addr
		◆R/W	0B1B	42844
	<i>Range/Units (Format: 16-bit unsigned)</i>	<i>Default</i>		
	0–500%	100		

P11.27 determines the upper limit of the torque command (motor rated torque is 100%).

Calculation equation for the motor rated torque:

Motor rated torque: $T(N.M) = \frac{P(W)}{\omega(rad/s)}$

Where:

P (W) value = P05.02

$\omega (rad/s) \text{ value} = \frac{P5.03 \times 2\pi}{60} = rad/s$

P11.28	Torque Offset Source	Type	Hex Addr	Dec Addr
		◆R/W	0B1C	42845
	<i>Range/Units (Format: 16-bit binary)</i>	<i>Default</i>		
	0: Disable	0		
	1: Analog signal input			
	2: RS-485 communication (Pr.11-29)			
	3: Controlled through external terminals (by Pr.11-30–Pr.11-32)			

P11.28 specifies the torque offset source.

When set to 3, the torque offset sources are P11.30, P11.31 or P11.32 according to the multi-function input terminal settings 31, 32 or 33.

Normally open (N.O.) contact: ON = contact closed, OFF = contact open

P11.32	P11.31	P11.30	Torque Offset
MI = 33 (Low)	MI = 32 (Mid)	MI = 31 (High)	
OFF	OFF	OFF	None
OFF	OFF	ON	P11.30
OFF	ON	OFF	P11.31
OFF	ON	ON	P11.30 + P11.31
ON	OFF	OFF	P11.32
ON	OFF	ON	P11.30 + P11.32
ON	ON	OFF	P11.31 + P11.32
ON	ON	ON	P11.30 + P11.31 + P11.32

	Type	Hex Addr	Dec Addr
P11.29 Torque Offset Setting	◆R/W	0B1D	42846
<i>Range/Units (Format: 16-bit signed)</i>	<i>Default</i>		
-100.0–100.0 %	0.0		

P11.29 determines the torque offset command. The motor rated torque is 100%.

The calculation equation for the motor rated torque:

$$\text{Motor rated torque: } T(N.M) = \frac{P(W)}{\omega(rad / s)}$$

$$P(W) \text{ value} = P05.02, \omega (rad / s) \text{ value} = P05.03; \frac{P5.03 \times 2\pi}{60} = rad / s$$

	Type	Hex Addr	Dec Addr
P11.30 High Torque Offset	◆R/W	0B1E	42847
P11.31 Middle Torque Offset	◆R/W	0B1F	42848
P11.32 Low Torque Offset	◆R/W	0B20	42849
<i>Range/Units (Format: 16-bit signed)</i>	<i>Default</i>		
-100.0–100.0 %	High: 30.0 Middle: 20.0 Low: 10.0		

When P11.28 is set to 3, the torque offset sources are P11.30, P11.31 or P11.32 according to the multi-function input terminals settings 31, 32 or 33. The motor rated torque is 100%.

The calculation equation for the motor rated torque:

$$\text{Motor rated torque: } T(N.M) = \frac{P(W)}{\omega(rad / s)}$$

$$P(W) \text{ value} = P05.02, \omega (rad / s) \text{ value} = P05.03; \frac{P5.03 \times 2\pi}{60} = rad / s$$

	Type	Hex Addr	Dec Addr
P11.33 Torque Command Source	◆R/W	0B21	42850
<i>Range/Units (Format: 16-bit unsigned)</i>	<i>Default</i>		
0: Digital keypad	0		
1: RS-485 communication (P11.34)			
2: Analog signal input (P03.00)			
5: Communication Card			

When P11.33 is set to 0 or 1, you can set the torque command in P11.34.

When P11.33 is set to 2 or 5, P11.34 only displays the torque command.

	Type	Hex Addr	Dec Addr
P11.34 Torque Command	◆R/W	0B22	42851
<i>Range/Units (Format: 16-bit signed)</i>	<i>Default</i>		
-100.0–100.0%	0.0		

This parameter sets the torque command. When P11.27 is 250% and P11.34 is 100%, the actual torque command = 250 × 100% = 250% of the motor rated torque.

The drive saves the settings before power is OFF.

	Type	Hex Addr	Dec Addr
P11.35 Torque Command Filter Time	◆R/W	0B23	42852
<i>Range/Units (Format: 16-bit unsigned)</i>	<i>Default</i>		
0.000–1.000 sec.	0.000		

When the P11.35 setting is too long, the control is stable but the control response is delayed. When the setting is too short, the response is quick but the control may be unstable. Adjust the setting according to your control and response situation.

	Type	Hex Addr	Dec Addr
P11.36 Speed Limit Selection	R/W	0B24	42853
<i>Range/Units (Format: 16-bit binary)</i>	<i>Default</i>		
0: Set by P11.37 (Forward Speed Limit) and P11.38 (Reverse Speed Limit)	0		
1: Set by P00.20 (Master Frequency Command (AUTO, REMOTE) Source) and P11.37, P11.38			
2: Set by P00.20 (Master Frequency Command (AUTO, REMOTE) Source)			

Speed limit function: when you use torque control mode, if the torque command is greater than the load, the motor accelerates until the motor speed equals the speed limit. At this time, it switches to speed control mode to stop acceleration.

When P11.36 = 1:

- When the torque command is positive, the forward speed limit is P00.20 and the reverse speed limit is P11.38. When the torque command is negative, the forward speed limit is P11.37 and the reverse speed limit is P00.20.
- Example:
In an unwinding application, if the torque command direction is different from the motor operating direction, the load drives the motor. In this case, the speed limit must be P11.37 or P11.38. Only in normal applications where the motor drives the load and the torque command is in the same direction as the speed limit can you set the speed limit according to P00.20.

In torque control mode, the F page of keypad displays the present speed limit value. For details on the keypad display, refer to the LED Function Description in Section 7-14 Digital Keypad (optional).

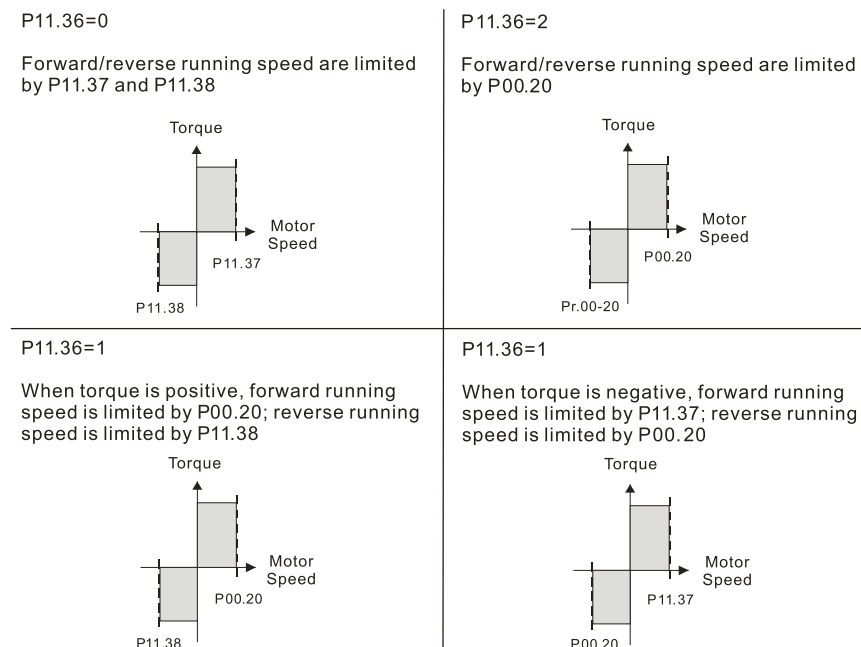

	<i>Type</i>	<i>Hex Addr</i>	<i>Dec Addr</i>
P11.37 Forward Speed Limit (Torque Mode)	◆R/W	0B25	42854
P11.38 Reverse Speed Limit (Torque Mode)	◆R/W	0B26	42855
<i>Range/Units (Format: 16-bit unsigned)</i>	<i>Default</i>		
0–120%	10		

P11.37 and P11.38 limit the speed for forward and reverse running in torque mode (P01.00 Maximum Operation Frequency = 100%).

	<i>Type</i>	<i>Hex Addr</i>	<i>Dec Addr</i>
P11.41 PWM Mode Selection	R/W	0B29	42858
<i>Range/Units (Format: 16-bit binary)</i>	<i>Default</i>		
0: Two-phase modulation mode	2		
2: Space vector modulation mode			

Two-phase modulation mode: effectively reduces the drive power component losses and provides better performance in long wiring applications.

Space vector modulation mode: effectively reduces the power loss and electromagnetic noise of the motor.

	<i>Type</i>	<i>Hex Addr</i>	<i>Dec Addr</i>
P11.42 System Control Flag	R/W	0B2A	42859
<i>Range/Units (Format: 16-bit unsigned)</i>	<i>Default</i>		
0000–FFFFh	0000		

bit No.	Function	Description
0	Reserved	
1	FWD / REV action control	0: FWD / REV cannot be controlled by Pr.02-12 bit 0 & 1. 1: FWD / REV can be controlled by Pr.02-12 bit 0 & 1.

GROUP P13.xx DETAILS – MACRO / USER DEFINED PARAMETERS

P13.00	Industry-specific Parameter Application	<u>Type</u>	<u>Hex Addr</u>	<u>Dec Addr</u>
	<i>Range/Units (Format: 16-bit binary)</i>	R/W	0D0D	43329
	00: Disabled	<u>Default</u>		
	01: User-defined parameter	00		
	02: Compressor			
	03: Fan			
	04: Pump			
	05: Conveyor			
	06: Machine tool			
	07: Packing			
	08: Textiles			
	10: Logistics			
	11: Tension PID			
	12: Tension PID + master / auxiliary frequency			



NOTE: : After you select the macro, some of the default values adjust automatically according to the application selection. If P13.00 is set to a macro selection, the drive must be set back to defaults (P00.02 =10) to revert all parameters to the original parameter settings.

P13.00=02: Compressor

The following table lists the relevant compressor setting application parameters.

Parameter	Parameter Name	Settings
P00.11	Speed control mode	0 (IMVF control mode)
P00.16	Load selection	0 (Normal load)
P00.17	Carrier frequency	Default setting
P00.20	Master frequency command source (AUTO, REMOTE)	2 (External analog input)
P00.21	Operation command source (AUTO, REMOTE)	1 (External terminals)
P00.22	Stop method	0 (Ramp to stop)
P00.23	Motor direction control	1 (Disable reverse)
P01.00	Maximum operation frequency	Default setting
P01.01	Output frequency of motor 1 (Base frequency / Motor's rated frequency)	Default setting
P01.02	Output voltage of motor 1 (Base voltage / Motor's rated voltage)	Default setting
P01.03	Mid-point frequency 1 of motor 1	Default setting
P01.04	Mid-point voltage 1 of motor 1	Default setting
P01.05	Mid-point frequency 2 of motor 1	Default setting
P01.06	Mid-point voltage 2 of motor 1	Default setting
P01.07	Minimum output frequency of motor 1	Default setting
P01.08	Minimum output voltage of motor 1	Default setting
P01.11	Output frequency lower limit	20 (Hz)
P01.12	Acceleration time 1	20 (sec.)
P01.13	Deceleration time 1	20 (sec.)
P03.00	Analog input selection (AI1)	0 (No function)
P03.01	Analog input selection (AI2)	1 (Frequency command)
P05.01	Full-load current for induction motor 1 (A)	Default setting
P05.03	Rated speed for induction motor 1 (rpm)	Default setting

P05.04	Number of poles for induction motor 1	Default setting
--------	---------------------------------------	-----------------

P13.00=03: Fan

The following table lists the relevant fan setting application parameters.

Parameter	Parameter Name	Settings
P00.11	Speed control mode	0 (IMVF)
P00.16	Load selection	0 (Normal load)
P00.17	Carrier frequency	Default setting
P00.20	Master frequency command source (AUTO, REMOTE)	2 (External analog input)
P00.21	Operation command source (AUTO, REMOTE)	1 (External terminals)
P00.22	Stop method	1 (Coast to stop)
P00.23	Motor direction control	1 (Disable reverse)
P00.30	Master frequency command source (HAND, LOCAL)	0 (Digital keypad)
P00.31	Operation command source (HAND, LOCAL)	0 (Digital keypad)
P01.00	Maximum operation frequency	Default setting
P01.01	Output frequency of motor 1 (Base frequency / Motor's rated frequency)	Default setting
P01.02	Output voltage of motor 1 (Base voltage / Motor's rated voltage)	Default setting
P01.03	Mid-point frequency 1 of motor 1	Default setting
P01.04	Mid-point voltage 1 of motor 1	Default setting
P01.05	Mid-point frequency 2 of motor 1	Default setting
P01.06	Mid-point voltage 2 of motor 1	Default setting
P01.07	Minimum output frequency of motor 1	Default setting
P01.08	Minimum output voltage of motor 1	Default setting
P01.10	Output frequency upper limit	50 (Hz)
P01.11	Output frequency lower limit	35 (Hz)
P01.12	Acceleration time 1	15 (sec.)
P01.13	Deceleration time 1	15 (sec.)
P01.43	V/F curve selection	2 (V/F curve to the power of 2)
P02.05	Multi-function input command 5 (DI5)	16 (Rotating speed command from AI2)
P02.16	Multi-function output 2 (DO1)	11 (Malfunction indication)
P02.17	Multi-function output 3 (DO2)	1 (Indication during RUN)
P03.00	Analog input selection (AI1)	1 (Frequency command)
P03.01	Analog input selection (AI2)	1 (Frequency command)
P03.28	AI1 terminal input selection	0 (0–10 V)
P03.29	AI2 terminal input selection	1 (0–10 V)
P03.31	AO1 output selection	0 (0–10 V)
P03.50	Analog input curve selection	1 (three-point curve of AI1)
P07.06	Restart after momentary power loss	2 (Speed tracking by the minimum output frequency)
P07.11	Number of times of restart after fault	5 (times)
P07.33	Auto-restart interval of fault	60 (sec.)

P13.00=04: Pump

The following table lists the relevant pump setting application parameters.

Parameter	Parameter Name	Settings
P00.11	Speed control mode	0 (IMVF)
P00.16	Load selection	0 (Normal load)
P00.20	Master frequency command source (AUTO, REMOTE)	2 (External analog input)
P00.21	Operation command source (AUTO, REMOTE)	1 (External terminals)
P00.23	Motor direction control	1 (Disable reverse)
P01.00	Maximum operation frequency	Default setting
P01.01	Output frequency of motor 1 (Base frequency / Motor's rated frequency)	Default setting
P01.02	Output voltage of motor 1 (Base voltage / Motor's rated voltage)	Default setting
P01.03	Mid-point frequency 1 of motor 1	Default setting
P01.04	Mid-point voltage 1 of motor 1	Default setting
P01.05	Mid-point frequency 2 of motor 1	Default setting
P01.06	Mid-point voltage 2 of motor 1	Default setting
P01.07	Minimum output frequency of motor 1	Default setting
P01.08	Minimum output voltage of motor 1	Default setting
P01.10	Output frequency upper limit	50 (Hz)
P01.11	Output frequency lower limit	35 (Hz)
P01.12	Acceleration time 1	15 (sec.)
P01.13	Deceleration time 1	15 (sec.)
P01.43	V/F curve selection	2 (V/F curve to the power of 2)
P07.06	Restart after momentary power loss	2 (Speed tracking by the minimum output frequency)
P07.11	Number of times of restart after fault	5 (times)
P07.33	Auto-restart interval of fault	60 (sec.)

P13.00=05: Conveyor

The following table lists the relevant conveyor setting application parameters.

Parameter	Parameter Name	Settings
P00.11	Speed control mode	0 (IMVF)
P00.16	Load selection	0 (Normal load)
P00.20	Master frequency command source (AUTO, REMOTE)	2 (External analog input)
P00.21	Operation command source (AUTO, REMOTE)	1 (External terminals)
P01.00	Maximum operation frequency	Default setting
P01.01	Output frequency of motor 1 (Base frequency / Motor's rated frequency)	Default setting
P01.02	Output voltage of motor 1 (Base voltage / Motor's rated voltage)	Default setting
P01.03	Mid-point frequency 1 of motor 1	Default setting
P01.04	Mid-point voltage 1 of motor 1	Default setting
P01.05	Mid-point frequency 2 of motor 1	Default setting
P01.06	Mid-point voltage 2 of motor 1	Default setting
P01.07	Minimum output frequency of motor 1	Default setting
P01.08	Minimum output voltage of motor 1	Default setting

Parameter	Parameter Name	Settings
P01.12	Acceleration time 1	10 (sec.)
P01.13	Deceleration time 1	10 (sec.)

P13.00=06: Machine Tool

The following table lists the relevant machine tool setting application parameters.

Parameter	Parameter Name	Settings
P00.11	Speed control mode	0 (IMVF)
P00.17	Carrier frequency	Default setting
P00.20	Master frequency command source (AUTO, REMOTE)	2 (External analog input)
P00.21	Operation command source (AUTO, REMOTE)	1 (External terminals)
P01.00	Maximum operation frequency	Default setting
P01.01	Output frequency of motor 1 (Base frequency / Motor's rated frequency)	Default setting
P01.02	Output voltage of motor 1 (Base voltage / Motor's rated voltage)	Default setting
P01.03	Mid-point frequency 1 of motor 1	0
P01.04	Mid-point voltage 1 of motor 1	0
P01.05	Mid-point frequency 2 of motor 1	0
P01.06	Mid-point voltage 2 of motor 1	0
P01.07	Minimum output frequency of motor 1	Default setting
P01.08	Minimum output voltage of motor 1	Default setting
P01.12	Acceleration time 1	5 (sec.)
P01.13	Deceleration time 1	5 (sec.)
P01.24	S-curve for acceleration begin time 1	0
P01.25	S-curve for acceleration arrival time 2	0
P01.26	S-curve for deceleration begin time 1	0
P01.27	S-curve for deceleration arrival time 2	0
P02.03	Multi-function input command 3 (DI3)	1 (Multi-step speed command 1)
P02.04	Multi-function input command 4 (DI4)	2 (Multi-step speed command 2)
P02.13	Multi-function output 1 (R1)	11 (Malfunction indication)
P02.16	Multi-function output 2 (DO1)	1 (Indication during RUN)
P02.17	Multi-function output 3 (DO2)	2 (Operation speed reached)
P03.00	Analog input selection (AI1)	1 (Frequency command)
P06.01	Over-voltage stall prevention	0 (Disabled)
P06.03	Over-current stall prevention during acceleration	0 (Disabled)
P06.04	Over-current stall prevention during operation	0 (Disabled)
P06.05	Acceleration / deceleration time selection for stall prevention at constant speed	0 (By current acceleration / deceleration time)
P07.01	DC brake current level	20 (%)
P07.03	DC brake time at STOP	0.3 (sec.)
P07.04	DC brake frequency at STOP	0 (Hz)
P07.23	Automatic voltage regulation (AVR) function	1 (Disable AVR)

P13.00=07: Packing

The following table lists the relevant compressor setting application parameters.

Parameter	Parameter Name	Settings
P00.11	Speed control mode	0 (IMVF)
P00.20	Master frequency command source (AUTO, REMOTE)	0 (Digital keypad)
P00.21	Operation command source (AUTO, REMOTE)	2 (RS-485 communication input)
P02.00	Two-wire / three-wire operation control	1 (two-wire mode 1, power on for operation control (M1: FWD / STOP, M2: REV / STOP))
P01.00	Maximum operation frequency	Default setting
P01.01	Output frequency of motor 1 (Base frequency / Motor's rated frequency)	Default setting
P01.02	Output voltage of motor 1 (Base voltage / Motor's rated voltage)	Default setting
P01.03	Mid-point frequency 1 of motor 1	Default setting
P01.04	Mid-point voltage 1 of motor 1	Default setting
P01.05	Mid-point frequency 2 of motor 1	Default setting
P01.06	Mid-point voltage 2 of motor 1	Default setting
P01.07	Minimum output frequency of motor 1	Default setting
P01.08	Minimum output voltage of motor 1	Default setting
P01.12	Acceleration time 1	10 (sec.)
P01.13	Deceleration time 1	10 (sec.)
P01.24	S-curve for acceleration begin time 1	Default setting
P01.25	S-curve for acceleration arrival time 2	Default setting
P01.26	S-curve for deceleration begin time 1	Default setting
P01.27	S-curve for deceleration arrival time 2	Default setting
P03.00	Analog input selection (AI1)	1 (Frequency command)
P03.28	AI1 terminal input selection	Default setting

P13.00=08: Textiles

The following table lists the relevant textile setting application parameters.

Parameter	Parameter Name	Settings
P00.11	Speed control mode	0 (IMVF)
P00.20	Master frequency command source (AUTO, REMOTE)	1 (RS-485 communication input)
P00.21	Operation command source (AUTO, REMOTE)	1 (External terminals)
P01.00	Maximum operation frequency	Default setting
P01.01	Output frequency of motor 1 (Base frequency / Motor's rated frequency)	Default setting
P01.02	Output voltage of motor 1 (Base voltage / Motor's rated voltage)	Default setting
P01.03	Mid-point frequency 1 of motor 1	Default setting
P01.04	Mid-point voltage 1 of motor 1	Default setting
P01.05	Mid-point frequency 2 of motor 1	Default setting
P01.06	Mid-point voltage 2 of motor 1	Default setting
P01.07	Minimum output frequency of motor 1	Default setting
P01.08	Minimum output voltage of motor 1	Default setting
P01.12	Acceleration time 1	10 (sec.)
P01.13	Deceleration time 1	10 (sec.)
P01.24	S-curve for acceleration begin time 1	0.2 (sec.)
P01.25	S-curve for acceleration arrival time 2	0.2 (sec.)

Parameter	Parameter Name	Settings
P01.26	S-curve for deceleration begin time 1	0.2 (sec.)
P01.27	S-curve for deceleration arrival time 2	0.2 (sec.)
P06.03	Over-current stall prevention during acceleration	180 (%)
P06.04	Over-current stall prevention during operation	180 (%)
P06.07	Over-torque detection level (motor 1)	200 (%)
P07.19	Fan cooling control	2 (Fan is ON when the AC motor drive runs; fan is OFF when the AC motor drive stops)

P13.00=10: Logistics

The following table lists the relevant logistics setting application parameters.

Parameter	Parameter Name	Settings
P00.20	Master frequency command source (AUTO, REMOTE)	7 (Digital keypad VR/potentiometer dial)
P00.21	Operation command source (AUTO, REMOTE)	1 (External terminals)
P01.00	Maximum operation frequency	Default setting
P01.01	Output frequency of motor 1 (Base frequency / Motor's rated frequency)	Default setting
P01.02	Output voltage of motor 1 (Base voltage / Motor's rated voltage)	400.0
P01.04	Mid-point voltage 1 of motor 1	20.0
P01.06	Mid-point voltage 2 of motor 1	20.0
P01.08	Minimum output voltage of motor 1	20.0
P01.03	Mid-point frequency 1 of motor 1	1.50
P01.07	Minimum output frequency of motor 1	1.50
P01.12	Acceleration time 1	3 (sec.)
P01.13	Deceleration time 1	3 (sec.)
P01.24	S-curve for acceleration begin time 1	0.00
P01.25	S-curve for acceleration arrival time 2	0.00
P01.26	S-curve for deceleration begin time 1	0.00
P01.27	S-curve for deceleration arrival time 2	0.00
P06.03	Over-current stall prevention during acceleration	200
P06.04	Over-current stall prevention during operation	200
P06.05	Acceleration / deceleration time selection for stall prevention at constant speed	2: By the second acceleration / deceleration time
P07.23	Automatic voltage regulation (AVR) function	1: Disable AVR
P07.26	Torque compensation gain	0

P13.00=11: PID

The following table lists the relevant PID setting application parameters.

Parameter	Parameter Name	Settings
P00.20	Master frequency command source (AUTO, REMOTE)	9 (PID controller)
P00.21	Operation command source (AUTO, REMOTE)	1 (External terminals)
P01.00	Maximum operation frequency	Default setting
P01.12	Acceleration time 1	3 (sec.)
P01.13	Deceleration time 1	3 (sec.)
P03.00	Analog input selection (AI1)	5 (PID feedback signal)
P03.50	Analog input curve selection	1: Three-point curve of AI1
P03.63	AVI voltage lowest point	0.00
P03.65	AVI voltage mid-point	9.99
P03.66	AVI proportional mid-point	100%
P08.00	Terminal selection of PID feedback	1: Negative PID feedback: by analog input (P03.00, P03.01)
P08.01	Proportional gain (P)	10
P08.02	Integral time (I)	1
P08.20	PID mode selection	1: Parallel connection
P08.21	Enable PID to change the operation direction	0: Operation direction cannot be changed
P08.65	PID target value source	1: P08.66 setting
P08.66	PID target value setting	50%

P13.00=12: Tension PID + Master/Aux Frequency

The following table lists the relevant tension PID setting application parameters.

Parameter	Parameter Name	Settings
P00.20	Master frequency command source (AUTO, REMOTE)	9 (PID controller)
P00.21	Operation command source (AUTO, REMOTE)	1 (External terminals)
P01.00	Maximum operation frequency	Default setting
P01.12	Acceleration time 1	3 (sec.)
P01.13	Deceleration time 1	3 (sec.)
P00.35	Auxiliary frequency source	3: Analog input
P03.00	Analog input selection (AI1)	5 (PID feedback signal)
P03.01	Analog input selection (AI2)	12: Auxiliary frequency input
P03.10	Reverse setting when analog signal input is negative frequency	0: Negative frequency input is not allowed. The digital keypad or external terminal controls the forward and reverse direction.
P03.12	Analog input gain (AI2)	100.0%
P03.29	AI2 terminal input selection	1: 0–10 V
P03.50	Analog input curve selection	1: Three-point curve of AI1
P03.63	AI1 voltage lowest point	0.00
P03.65	AI1 voltage mid-point	9.99
P03.66	AI1 proportional mid-point	100%
P08.00	Terminal selection of PID feedback	1: Negative PID feedback: by analog input (P03.00, P03.01)
P08.01	Proportional gain (P)	10
P08.02	Integral time (I)	1
P08.20	PID mode selection	1: Parallel connection

Parameter	Parameter Name	Settings
P08.21	Enable PID to change the operation direction	0: Operation direction cannot be changed
P08.65	PID target value source	1: P08.66 setting
P08.66	PID target value setting	50%
P08.67	Master and auxiliary reverse running cutoff frequency	10%

P13.00=1, User-defined Parameters

Parameters 13.01 through 13.50 are blank for your use. You can record any user defined parameter settings here if you wish.

	Type	Hex Addr	Dec Addr
P13.01	◆R/W	0D01	43330
<i>Range/Units (Format: 16-bit unsigned)</i>	<i>Default</i>		

	Type	Hex Addr	Dec Addr
P13.02	◆R/W	0D02	43331
<i>Range/Units (Format: 16-bit unsigned)</i>	<i>Default</i>		

	Type	Hex Addr	Dec Addr
P13.03	◆R/W	0D03	43332
<i>Range/Units (Format: 16-bit unsigned)</i>	<i>Default</i>		

	Type	Hex Addr	Dec Addr
P13.04	◆R/W	0D04	43333
<i>Range/Units (Format: 16-bit unsigned)</i>	<i>Default</i>		

	Type	Hex Addr	Dec Addr
P13.05	◆R/W	0D05	43334
<i>Range/Units (Format: 16-bit unsigned)</i>	<i>Default</i>		

	Type	Hex Addr	Dec Addr
P13.06	◆R/W	0D06	43335
<i>Range/Units (Format: 16-bit unsigned)</i>	<i>Default</i>		

	Type	Hex Addr	Dec Addr
P13.07	◆R/W	0D07	43336
<i>Range/Units (Format: 16-bit unsigned)</i>	<i>Default</i>		

P13.08	<i>Range/Units (Format: 16-bit unsigned)</i>	<i>Type</i> ◆R/W	<i>Hex Addr</i> 0D08	<i>Dec Addr</i> 43337
		<i>Default</i>		
P13.09	<i>Range/Units (Format: 16-bit unsigned)</i>	<i>Type</i> ◆R/W	<i>Hex Addr</i> 0D09	<i>Dec Addr</i> 43338
		<i>Default</i>		
P13.10	<i>Range/Units (Format: 16-bit unsigned)</i>	<i>Type</i> ◆R/W	<i>Hex Addr</i> 0D0A	<i>Dec Addr</i> 43339
		<i>Default</i>		
P13.11	<i>Range/Units (Format: 16-bit unsigned)</i>	<i>Type</i> ◆R/W	<i>Hex Addr</i> 0D0B	<i>Dec Addr</i> 43340
		<i>Default</i>		
P13.12	<i>Range/Units (Format: 16-bit unsigned)</i>	<i>Type</i> ◆R/W	<i>Hex Addr</i> 0D0C	<i>Dec Addr</i> 43341
		<i>Default</i>		
P13.13	<i>Range/Units (Format: 16-bit unsigned)</i>	<i>Type</i> ◆R/W	<i>Hex Addr</i> 0D0D	<i>Dec Addr</i> 43342
		<i>Default</i>		
P13.14	<i>Range/Units (Format: 16-bit unsigned)</i>	<i>Type</i> ◆R/W	<i>Hex Addr</i> 0D0E	<i>Dec Addr</i> 43343
		<i>Default</i>		
P13.15	<i>Range/Units (Format: 16-bit unsigned)</i>	<i>Type</i> ◆R/W	<i>Hex Addr</i> 0D0F	<i>Dec Addr</i> 43344
		<i>Default</i>		
P13.16	<i>Range/Units (Format: 16-bit unsigned)</i>	<i>Type</i> ◆R/W	<i>Hex Addr</i> 0D10	<i>Dec Addr</i> 43345
		<i>Default</i>		

	<u>Type</u>	<u>Hex Addr</u>	<u>Dec Addr</u>
P13.17	◆R/W	0D11	43346
<i>Range/Units (Format: 16-bit unsigned)</i>	<i>Default</i>		

	<u>Type</u>	<u>Hex Addr</u>	<u>Dec Addr</u>
P13.18	◆R/W	0D12	43347
<i>Range/Units (Format: 16-bit unsigned)</i>	<i>Default</i>		

	<u>Type</u>	<u>Hex Addr</u>	<u>Dec Addr</u>
P13.19	◆R/W	0D13	43348
<i>Range/Units (Format: 16-bit unsigned)</i>	<i>Default</i>		

	<u>Type</u>	<u>Hex Addr</u>	<u>Dec Addr</u>
P13.20	◆R/W	0D14	43349
<i>Range/Units (Format: 16-bit unsigned)</i>	<i>Default</i>		

	<u>Type</u>	<u>Hex Addr</u>	<u>Dec Addr</u>
P13.21	◆R/W	0D15	43350
<i>Range/Units (Format: 16-bit unsigned)</i>	<i>Default</i>		

	<u>Type</u>	<u>Hex Addr</u>	<u>Dec Addr</u>
P13.22	◆R/W	0D16	43351
<i>Range/Units (Format: 16-bit unsigned)</i>	<i>Default</i>		

	<u>Type</u>	<u>Hex Addr</u>	<u>Dec Addr</u>
P13.23	◆R/W	0D17	43352
<i>Range/Units (Format: 16-bit unsigned)</i>	<i>Default</i>		

	<u>Type</u>	<u>Hex Addr</u>	<u>Dec Addr</u>
P13.24	◆R/W	0D18	43353
<i>Range/Units (Format: 16-bit unsigned)</i>	<i>Default</i>		

	<u>Type</u>	<u>Hex Addr</u>	<u>Dec Addr</u>
P13.25	◆R/W	0D19	43354
<i>Range/Units (Format: 16-bit unsigned)</i>	<i>Default</i>		

P13.26	<i>Range/Units (Format: 16-bit unsigned)</i>	<i>Type</i> ◆R/W	<i>Hex Addr</i> 0D1A	<i>Dec Addr</i> 43355
		<i>Default</i>		
P13.27	<i>Range/Units (Format: 16-bit unsigned)</i>	<i>Type</i> ◆R/W	<i>Hex Addr</i> 0D1B	<i>Dec Addr</i> 43356
		<i>Default</i>		
P13.28	<i>Range/Units (Format: 16-bit unsigned)</i>	<i>Type</i> ◆R/W	<i>Hex Addr</i> 0D1C	<i>Dec Addr</i> 43357
		<i>Default</i>		
P13.29	<i>Range/Units (Format: 16-bit unsigned)</i>	<i>Type</i> ◆R/W	<i>Hex Addr</i> 0D1D	<i>Dec Addr</i> 43358
		<i>Default</i>		
P13.30	<i>Range/Units (Format: 16-bit unsigned)</i>	<i>Type</i> ◆R/W	<i>Hex Addr</i> 0D1E	<i>Dec Addr</i> 43359
		<i>Default</i>		
P13.31	<i>Range/Units (Format: 16-bit unsigned)</i>	<i>Type</i> ◆R/W	<i>Hex Addr</i> 0D1F	<i>Dec Addr</i> 43360
		<i>Default</i>		
P13.32	<i>Range/Units (Format: 16-bit unsigned)</i>	<i>Type</i> ◆R/W	<i>Hex Addr</i> 0D20	<i>Dec Addr</i> 43361
		<i>Default</i>		
P13.33	<i>Range/Units (Format: 16-bit unsigned)</i>	<i>Type</i> ◆R/W	<i>Hex Addr</i> 0D21	<i>Dec Addr</i> 43362
		<i>Default</i>		
P13.34	<i>Range/Units (Format: 16-bit unsigned)</i>	<i>Type</i> ◆R/W	<i>Hex Addr</i> 0D22	<i>Dec Addr</i> 43363
		<i>Default</i>		

	<u>Type</u>	<u>Hex Addr</u>	<u>Dec Addr</u>
P13.35	◆R/W	0D23	43364
<i>Range/Units (Format: 16-bit unsigned)</i>	<i>Default</i>		

	<u>Type</u>	<u>Hex Addr</u>	<u>Dec Addr</u>
P13.36	◆R/W	0D24	43365
<i>Range/Units (Format: 16-bit unsigned)</i>	<i>Default</i>		

	<u>Type</u>	<u>Hex Addr</u>	<u>Dec Addr</u>
P13.37	◆R/W	0D25	43366
<i>Range/Units (Format: 16-bit unsigned)</i>	<i>Default</i>		

	<u>Type</u>	<u>Hex Addr</u>	<u>Dec Addr</u>
P13.38	◆R/W	0D26	43367
<i>Range/Units (Format: 16-bit unsigned)</i>	<i>Default</i>		

	<u>Type</u>	<u>Hex Addr</u>	<u>Dec Addr</u>
P13.39	◆R/W	0D27	43368
<i>Range/Units (Format: 16-bit unsigned)</i>	<i>Default</i>		

	<u>Type</u>	<u>Hex Addr</u>	<u>Dec Addr</u>
P13.40	◆R/W	0D28	43369
<i>Range/Units (Format: 16-bit unsigned)</i>	<i>Default</i>		

	<u>Type</u>	<u>Hex Addr</u>	<u>Dec Addr</u>
P13.41	◆R/W	0D29	43370
<i>Range/Units (Format: 16-bit unsigned)</i>	<i>Default</i>		

	<u>Type</u>	<u>Hex Addr</u>	<u>Dec Addr</u>
P13.42	◆R/W	0D2A	43371
<i>Range/Units (Format: 16-bit unsigned)</i>	<i>Default</i>		

	<u>Type</u>	<u>Hex Addr</u>	<u>Dec Addr</u>
P13.43	◆R/W	0D2B	43372
<i>Range/Units (Format: 16-bit unsigned)</i>	<i>Default</i>		

	<i>Type</i>	<i>Hex Addr</i>	<i>Dec Addr</i>
<u>P13.44</u>	◆R/W	0D2C	43373
<i>Range/Units (Format: 16-bit unsigned)</i>	<i>Default</i>		

	<i>Type</i>	<i>Hex Addr</i>	<i>Dec Addr</i>
<u>P13.45</u>	◆R/W	0D2D	43374
<i>Range/Units (Format: 16-bit unsigned)</i>	<i>Default</i>		

	<i>Type</i>	<i>Hex Addr</i>	<i>Dec Addr</i>
<u>P13.46</u>	◆R/W	0D2E	43375
<i>Range/Units (Format: 16-bit unsigned)</i>	<i>Default</i>		

	<i>Type</i>	<i>Hex Addr</i>	<i>Dec Addr</i>
<u>P13.47</u>	◆R/W	0D2F	43376
<i>Range/Units (Format: 16-bit unsigned)</i>	<i>Default</i>		

	<i>Type</i>	<i>Hex Addr</i>	<i>Dec Addr</i>
<u>P13.48</u>	◆R/W	0D30	43377
<i>Range/Units (Format: 16-bit unsigned)</i>	<i>Default</i>		

	<i>Type</i>	<i>Hex Addr</i>	<i>Dec Addr</i>
<u>P13.49</u>	◆R/W	0D31	43378
<i>Range/Units (Format: 16-bit unsigned)</i>	<i>Default</i>		

	<i>Type</i>	<i>Hex Addr</i>	<i>Dec Addr</i>
<u>P13.50</u>	◆R/W	0D32	43379
<i>Range/Units (Format: 16-bit unsigned)</i>	<i>Default</i>		

GROUP P14.xx DETAILS – PROTECTION PARAMETERS (2)

	<i>Type</i>	<i>Hex Addr</i>	<i>Dec Addr</i>
P14.50 <i>Output Frequency at Malfunction 2</i>	Read	0E32	43635
P14.54 <i>Output Frequency at Malfunction 3</i>	Read	0E36	43639
P14.58 <i>Output Frequency at Malfunction 4</i>	Read	0E3A	43643
P14.62 <i>Output Frequency at Malfunction 5</i>	Read	0E3E	43647
P15.66 <i>Output Frequency at Malfunction 6</i>	Read	0E42	43651
<i>Range/Units (Format: 16-bit unsigned)</i>	<i>Default</i>		
0.00–599.00 Hz	0		

When an error occurs, you can check the output frequency for the malfunction. If the error happens again, this parameter overwrites the previous record.

	<i>Type</i>	<i>Hex Addr</i>	<i>Dec Addr</i>
P14.51 <i>DC bus Voltage at Malfunction 2</i>	Read	0E33	43636
P14.55 <i>DC bus Voltage at Malfunction 3</i>	Read	0E37	43640
P14.59 <i>DC bus Voltage at Malfunction 4</i>	Read	0E3B	43644
P14.63 <i>DC bus Voltage at Malfunction 5</i>	Read	0E3F	43648
P14.67 <i>DC bus Voltage at Malfunction 6</i>	Read	0E43	43652
<i>Range/Units (Format: 16-bit unsigned)</i>	<i>Default</i>		
0.0–6553.5 V	0		

When an error occurs, you can check the DC bus voltage for the malfunction. If the error happens again, this parameter overwrites the previous record.

	<i>Type</i>	<i>Hex Addr</i>	<i>Dec Addr</i>
P14.52 <i>Output Current at Malfunction 2</i>	Read	0E34	43637
P14.56 <i>Output Current at Malfunction 3</i>	Read	0E38	43641
P14.60 <i>Output Current at Malfunction 4</i>	Read	0E3C	43645
P14.64 <i>Output Current at Malfunction 5</i>	Read	0E40	43649
P14.68 <i>Output Current at Malfunction 6</i>	Read	0E44	43653
<i>Range/Units (Format: 16-bit unsigned)</i>	<i>Default</i>		
0.00–655.35 Amps	0		

When an error occurs, you can check the output current for the malfunction. If the error happens again, this parameter overwrites the previous record.

	<i>Type</i>	<i>Hex Addr</i>	<i>Dec Addr</i>
P14.53 <i>IGBT Temperature at Malfunction 2</i>	Read	0E35	43638
P14.57 <i>IGBT Temperature at Malfunction 3</i>	Read	0E39	43642
P14.61 <i>IGBT Temperature at Malfunction 4</i>	Read	0E3D	43646
P14.65 <i>IGBT Temperature at Malfunction 5</i>	Read	0E41	43650
P14.69 <i>IGBT Temperature at Malfunction 6</i>	Read	0E45	43654
<i>Range/Units (Format: 16-bit signed)</i>	<i>Default</i>		
-3276.7–3276.7 °C	0		

When an error occurs, you can check the IGBT temperature for the malfunction. If the error happens again, this parameter overwrites the previous record.

	<i>Type</i>	<i>Hex Addr</i>	<i>Dec Addr</i>
<u>P14.70</u> <i>Fault Record 7</i>	Read	0E46	43655
<u>P14.71</u> <i>Fault Record 8</i>	Read	0E47	43656
<u>P14.72</u> <i>Fault Record 9</i>	Read	0E48	43657
<u>P14.73</u> <i>Fault Record 10</i>	Read	0E49	43658
<i>Range/Units (Format: 16-bit unsigned)</i>	<i>Default</i>		
Settings	0		
0: No fault record			
1: Over-current during acceleration (ocA)			
2: Over-current during deceleration (ocd)			
3: Over-current during steady operation (ocn)			
4: Ground fault (GFF)			
6: Over-current at STOP (ocS)			
7: Over-voltage during acceleration (ovA)			
8: Over-voltage during deceleration (ovd)			
9: Over-voltage during constant speed (ovn)			
10: Over-voltage at stop (ovS)			
11: Low-voltage during acceleration (LvA)			
12: Low-voltage during deceleration (Lvd)			
13: Low-voltage during constant speed (Lvn)			
14: Low-voltage at stop (LvS)			
15: Phase loss protection (orP)			
16: IGBT overheating (oH1)			
18: IGBT temperature detection failure (tH1o)			
21: Over load (oL)			
22: Electronics thermal relay 1 protection (EoL1)			
23: Electronics thermal relay 2 protection (EoL2)			
24: Motor PTC overheating (oH3)			
26: Over-torque 1 (ot1)			
27: Over-torque 2 (ot2)			
28: Under current (uC)			
31: EEPROM read error (cF2)			
33: U-phase error (cd1)			
34: V-phase error (cd2)			
35: W-phase error (cd3)			
36: cc (current clamp) hardware error (Hd0)			
37: oc (over-current) hardware error (Hd1)			
40: Auto-tuning error (AUE)			
41: PID loss AI2 (AFE)			
43: PG feedback loss (PGF2)			
44: PG feedback stall (PGF3)			
45: PG slip error (PGF4)			
48: AI2 loss (ACE)			
49: External fault (EF)			
50: Emergency stop (EF1)			
51: External Base Block (bb)			
52: Password is locked (Pcod)			
54: Illegal command (CE1)			
55: Illegal data address (CE2)			
56: Illegal data value (CE3)			
57: Data is written to read-only address (CE4)			
58: Modbus transmission time-out (CE10)			
61: Y-connection / Δ-connection switch error (ydc)			

- 62: Deceleration energy backup error (dEb)
- 63: Over slip error (oSL)
- 72: STO Loss (STL1)
- 76: STO (STo)
- 77: STO Loss 2 (STL2)
- 78: STO Loss 3 (STL3)
- 79: U-phase over-current before run (Aoc)
- 80: V-phase over-current before run (boc)
- 81: W-phase over-current before run (coc)
- 82: Output phase loss U phase (oPL1)
- 83: Output phase loss V phase (oPL2)
- 84: Output phase loss W phase (oPL3)
- 87: Low frequency overload protection (oL3)
- 89: Rotor position detection error (roPd)
- 97: Ethercat Card Timeout (CD10)
- 111: InrCOM time-out error (ictE)
- 121: Internal communication error (CP20)
- 123: Internal communication error (CP22)
- 124: Internal communication error (CP30)
- 126: Internal communication error (CP32)
- 127: Internal communication error (CP33)
- 128: Over-torque 3 (ot3)
- 129: Over-torque 4 (ot4)
- 134: Internal communication error (EoL3)
- 135: Internal communication error (EoL4)
- 140: Oc hardware error (Hd6)
- 141: GFF occurs before run (b4GFF)
- 142: Auto-tune error 1 (DC test stage) (AuE1)
- 143: Auto-tune error 2 (High frequency test stage) (AuE2)
- 144: Auto-tune error 3 (Rotary test stage) (AuE3)
- 149: Auto-tune error 5 (Rotor resistance measure test stage)

The parameters record when the fault occurs and forces a stop.

- When low-voltage at stop fault (LvS) occurs, the fault is not recorded. When low-voltage during operation faults (LvA, Lvd, Lvn) occur, the faults are recorded.
- When the dEb function is valid and enabled, the drive executes dEb and records fault code 62 to P06.17–P06.22 and P14.70–P14.73 simultaneously.

	Type	Hex Addr	Dec Addr
P14.74 Over-torque Detection Selection (Motor 3)	◆R/W	0E4A	43659
P14.77 Over-torque Detection Selection (Motor 4)	◆R/W	0E4D	43662
<i>Range/Units (Format: 16-bit binary)</i>	<i>Default</i>		
0: No function	0		
1: Continue operation after over-torque detection during constant speed operation			
2: Stop after over-torque detection during constant speed operation			
3: Continue operation after over-torque detection during RUN			
4: Stop after over-torque detection during RUN			

When you set P14.74 and P14.77 to 1 or 3, a warning message displays but there is no error record.

When you set P14.74 and P14.77 to 2 or 4, an error message displays and there is an error record.

	Type	Hex Addr	Dec Addr
P14.75 Over-torque Detection Level (Motor 3)	◆R/W	0E4B	43660
P14.78 Over-torque Detection Level (Motor 4)	◆R/W	0E4E	43663
<i>Range/Units (Format: 16-bit unsigned)</i>	<i>Default</i>		
10–250% (100% corresponds to the rated current of the drive)	120		

	Type	Hex Addr	Dec Addr
P14.76 Over-torque Detection Time (Motor 3)	◆R/W	0E4C	43661
P14.79 Over-torque Detection Time (Motor 4)	◆R/W	0E4F	43664
<i>Range/Units (Format: 16-bit unsigned)</i>	<i>Default</i>		
0.1–60.0 sec.	0.1		

When the output current exceeds the over-torque detection level (P14.75 or P14.78) and also exceeds the over-torque detection time (P14.76 or P14.79), the over-torque detection follows the setting of P14.74 or P14.77.

When you set P14.74 or P14.77 to 1 or 3, an ot3/ot4 warning displays while the drive keeps running after over-torque detection. The warning remains on until the output current is smaller than 5% of the over-torque detection level.

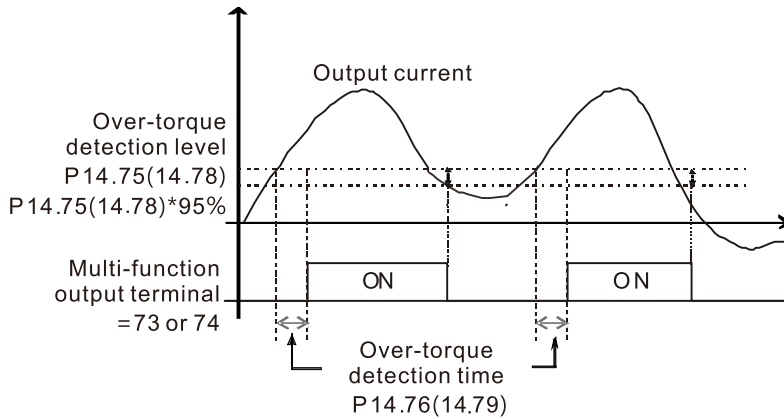

When you set P14.74 or P14.77 to 2 or 4, an ot3/ot4 warning displays and the drive stops running after over-torque detection. The drive does not run until you manually reset it.

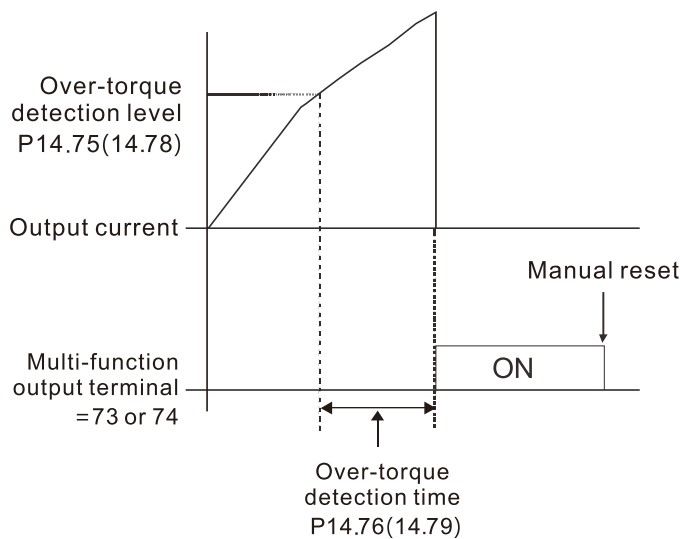

P14.80 Electronic Thermal Relay Selection 3 (Motor 3)

P14.82 Electronic Thermal Relay Selection 4 (Motor 4)

Range/Units (Format: 16-bit binary)

- 0: Inverter motor (with external forced cooling)
- 1: Standard motor (motor with the fan on the shaft)
- 2: Disable

Type	Hex Addr	Dec Addr
◆R/W	0E50	43665
◆R/W	0E52	43667
<i>Default</i>		
		2

These parameters prevent self-cooled motors from overheating under low speed. Use an electronic thermal relay to limit the drive’s output power.

- Setting the parameter to 0 is suitable for an inverter motor (motor fan using an independent power supply). For this kind of motor, there is no significant correlation between cooling capacity and motor speed. Therefore, the action of electronic thermal relays remains stable in low speed to ensure the load capability of the motor in low speed.
- Setting the parameter to 1 is suitable for standard motor (motor fan is fixed on the rotor shaft). For this kind of motor, the cooling capacity is lower in low speed; therefore, the action of an electronic thermal relay reduces the action time to ensure the life of motor.

When the power is cycled frequently, if the power is switched OFF, the electronic thermal relay protection is reset; therefore, even setting the parameter to 0 or 1 may not protect the motor well. If there are several motors connected to one drive, install an electronic thermal relay in each motor.

P14.81 Electronic Thermal Relay Action Time 3 (Motor 3)

P14.83 Electronic Thermal Relay Action Time 4 (Motor 4)

Range/Units (Format: 16-bit unsigned)

30.0–600.0 sec.

Type	Hex Addr	Dec Addr
◆R/W	0E51	43666
◆R/W	0E53	43668
<i>Default</i>		
		60.0

The electronic thermal relay amperage threshold is based on 150% of the parameter value in “Full Load Current for Induction Motor X” (P05.64 for motor 1, P05.70 for motor 2)

Set Parameter P14.81 or P14.83 for the amount of time the motor exceeds this threshold. Proper setup will prevent motor damage due to overheating. When it reaches the setting, the drive displays “EoL3 / EoL4”, and the motor coasts to stop.

Use this parameter to set the action time of the electronic thermal relay. It works based on the I2t characteristic curve of electronic thermal relay, the output frequency and current of the drive, and the operation time to prevent the motor from overheating.

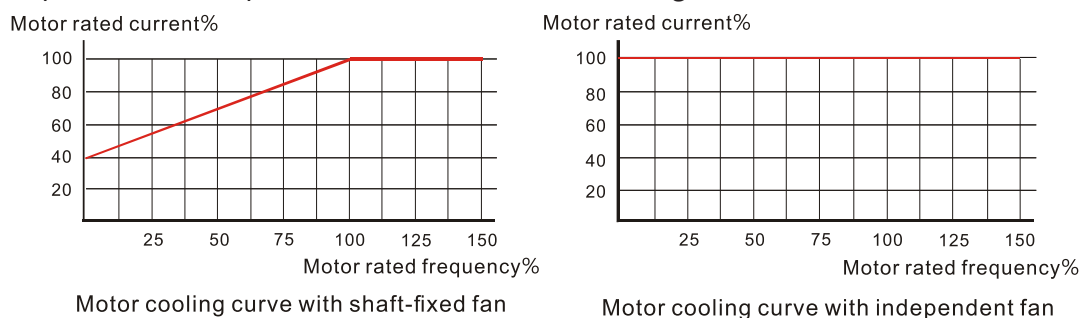

The action of the electronic thermal relay depends on the settings for P14.80 and P14.82:

- 1) P14.80 or P14.82 is set to 0 (using inverter motor):
When the output current of the drive is higher than 150% of the motor rated current (refer to the motor rated current % corresponded to the motor rated frequency in the motor cooling curve with independent fan), the drive starts to count the time. The electronic thermal relay acts when the accumulated time exceeds P14.81 or P14.83.

- 2) P14.80 or P14.82 is set to 1 (using standard motor):
 When the output current of the drive is higher than 150% of the motor rated current (refer to the motor rated current % corresponded to the motor rated frequency in the motor cooling curve with shaft-fixed fan), the drive starts to count the time. The electronic thermal relay acts when the accumulated time exceeds P14.81 or P14.83.

The actual electronic thermal relay action time adjusts according to the drive output current (shown as the motor loading rate %). The action time is short when the current is high, and the action time is long when the current is low. Refer to the following diagram.

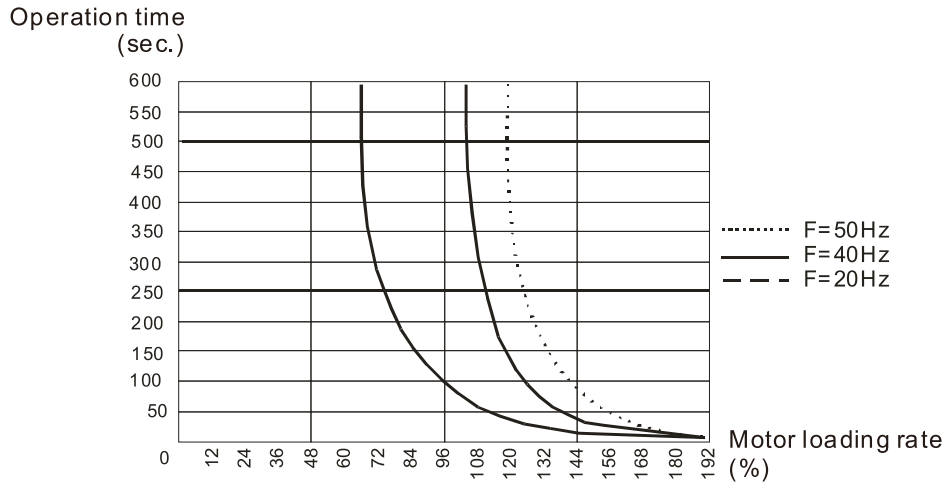

ADJUSTMENTS AND APPLICATIONS

This section provides step-by-step information on how to optimize the advanced speed and torque control modes of the GS20(X) drive. These setup guides are not used for the basic speed control modes of V/F and IMVFPG (P00.11=0 or 1). These procedures are not required for advanced speed control, but will ensure your drive and motor perform at the highest level.

The following three procedures can be found in this section:

- 1) FOC sensorless vector mode with standard induction motor (IM) adjustment procedure.
- 2) TQC sensorless vector mode standard induction motor (IM) adjustment procedure.
- 3) PMSVC mode with permanent magnet motor (PM) adjustment procedure.

FOC SENSORLESS VECTOR MODE WITH STANDARD INDUCTION MOTOR (IM) ADJUSTMENT PROCEDURE

Flow Chart

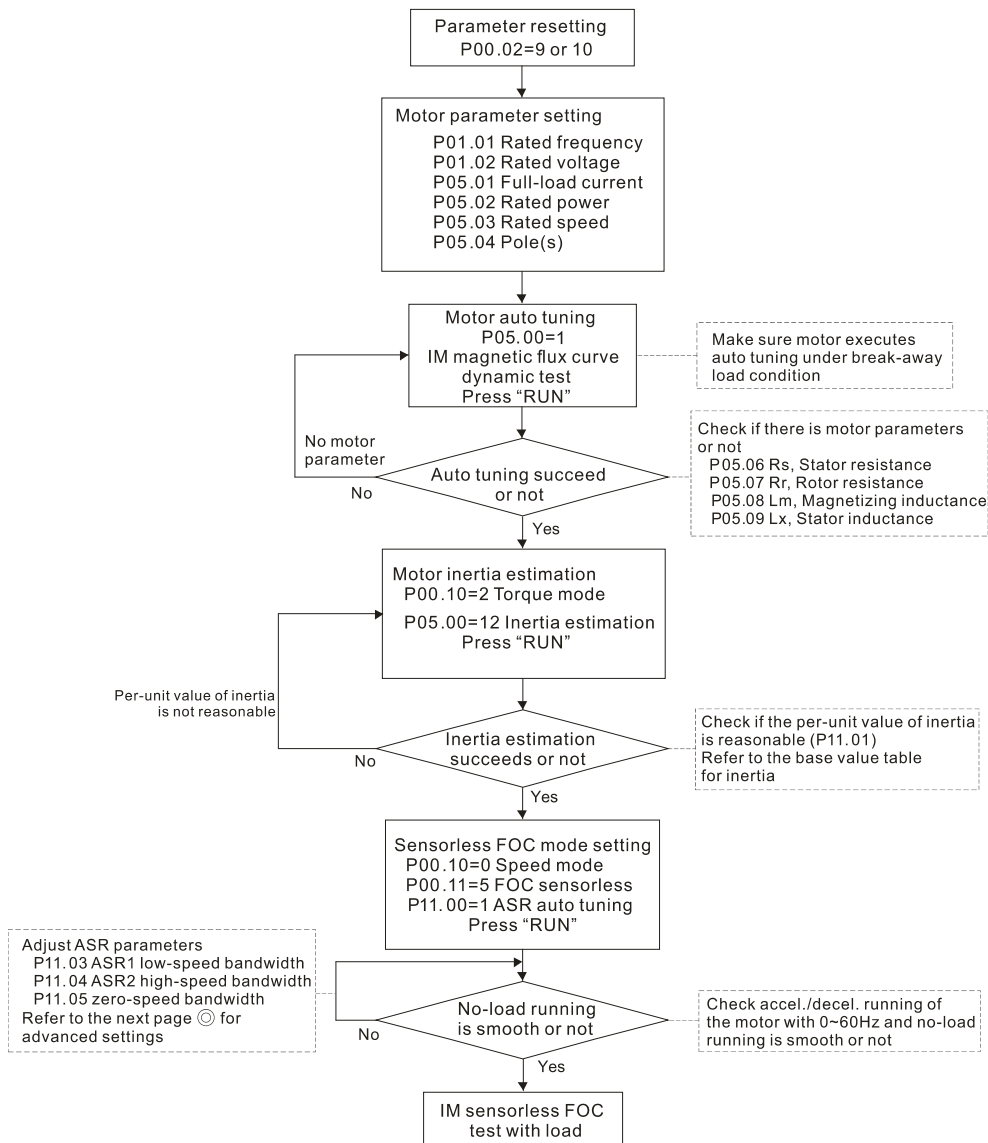

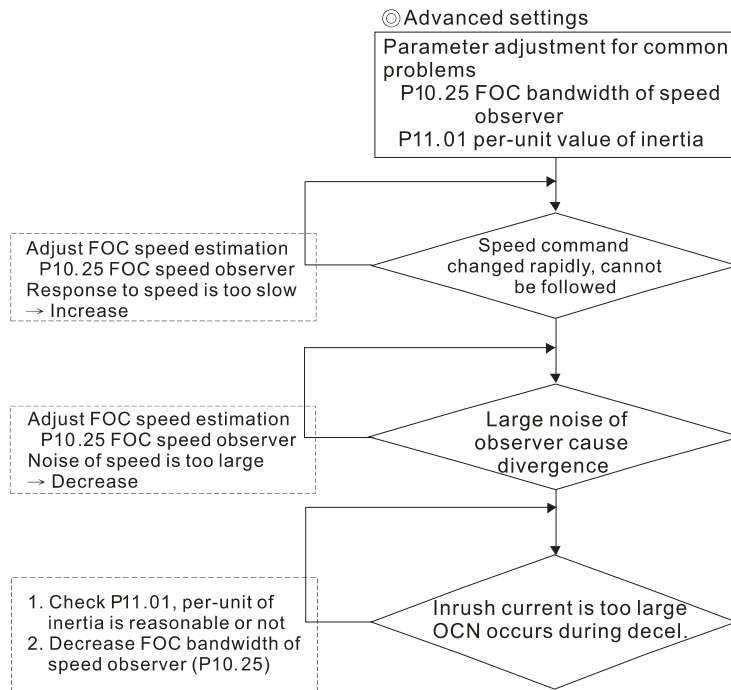

FOC control diagram

Please see the function block diagrams under P00.11 on page 4–59.

Adjustment Procedure

- 1) Parameter reset to default, P00.02=10 or 9
 (To avoid other parameters that are not related affecting the motor control)
- 2) Set up the following motor parameters according to the nameplate on the motor:
 - P01.01, Output Frequency of Motor 1
 - P01.02, Output Voltage of Motor 1
 - P05.01, Full-load Current for Induction Motor 1
 - P05.02, Rated Power for Induction Motor 1
 - P05.03, Rated Speed for Induction Motor 1
 - P05.04, Number of Poles for Induction Motor 1
- 3) Press RUN to start auto-tuning of IM magnetic flux curve dynamic test for P05.00=1 or 6 (motor is running). Make sure the motor executes auto-tuning under break-away load condition. Check if there are motor parameters after auto-tuning.
 - P05.06, Stator Resistance (Rs) for Induction Motor 1
 - P05.07, Rotor Resistance (Rr) for Induction Motor 1
 - P05.08, Magnetizing Inductance (Lm) for Induction Motor 1
 - P05.09, Stator Inductance (Lx) for Induction Motor 1
- 4) Execute estimation of the motor inertia (optional). Press “RUN” to start the estimation after finishing the settings for the parameters mentioned below.
 - P00.10=2: Torque mode
 - P05.00=12: FOC sensorless inertia estimation (motor is running)

After inertia estimation is finished, check if the estimated value for P11.01 is reasonable, refer to the base value table below (unit = kg•cm²):

Power	Setting
1HP	2.3
2HP	4.3
3HP	8.3
5HP	14.8
7.5HP	26.0
10HP	35.8
12HP	54.8
15HP	74.3
20HP	95.3

Power	Setting
25HP	142.8
30HP	176.5
40HP	202.5
50HP	355.5
60HP	410.8
75HP	494.8
100HP	1056.5
125HP	1275.3
150HP	1900.0

Power	Setting
175HP	2150.0
250HP	2800.0
300HP	3550.0
375HP	5139.0
425HP	5981.0
475HP	7053.0
600HP	9643.0
650HP	10734.0
750HP	13000.0

5) Execute IM sensorless FOC mode and set up the following parameters:

- P00.10=0, set as speed mode
- P00.11=5, set as FOC sensorless mode
- P11.00 bit0=1, use ASR gain auto-tuning

Press RUN and start the test with no load. Accelerate the motor to the rated speed, then decelerate to stop and check if the motor runs smoothly.

- a) If the motor runs smoothly, then the setting for IM Sensorless FOC is complete.
- b) If the motor does not run smoothly, or fails to start at low frequency, refer to the following steps for adjustment.

6) Select auto-tuning gain (P11.00 bit0=1) and adjust ASR parameters according to the speed response.

- P11.00 bit0=1, use auto-tuning for ASR.
- P11.03, ASR1 low-speed bandwidth. When the acceleration of low-speed cannot follow the acceleration command, increase the low-speed bandwidth.
- P11.04, ASR2 high-speed bandwidth. When the acceleration in high speed causes vibration or cannot follow the acceleration command, increase high-speed bandwidth.
- P11.05, Zero-speed bandwidth. If the response of start-up is slow or incapable, increase zero-speed bandwidth.

The bigger the setting value for ASR bandwidth, the faster the response.

The low speed bandwidth cannot be set too high, or the observer will diverge.

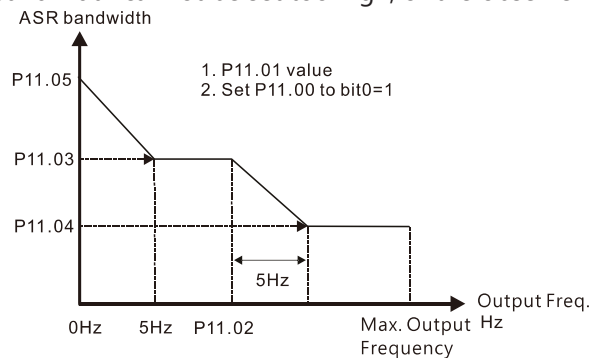

ASR adjustment- auto gain

7) Adjust the setting of FOC speed observer and per-unit value of inertia (common problems).

- a) P10.25: Set up FOC bandwidth of speed observer
 - Situation 1: Speed command changes rapidly, but speed response cannot follow. Speed response is too slow, increase the setting value.
 - Situation 2: The noise of the observer is too large, and causes the operation to diverge. Speed noise is too large, decrease the setting value.
- b) P11.01: Set up per unit of system inertia

- *Situation 1: The inrush current is too high at startup and causes an oc error.*
- *Situation 2: An ocn error occurs during RUN or STOP and the motor runs randomly.*
 - *Check P11.01 and determine whether the JM per-unit of system inertia is too large.*
 - *Decrease P10.25 FOC bandwidth for speed observer, or P11.05 zero-speed bandwidth.*

TQC SENSORLESS VECTOR MODE STANDARD INDUCTION MOTOR (IM) ADJUSTMENT PROCEDUREAdjustment Procedure

- 1) Set P00.02=9 (50Hz) or 10 (60Hz) to go back to factory setting.
- 2) Set the following parameters based on the nameplate values of the IM motor you are using:
 - P01.00, Induction Motor Max Frequency (Hz)
 - P01.01, Induction Motor Rated Frequency (Hz)
 - P01.02, Induction Motor Rated Voltage (V)
 - P05.01, Induction Motor Rated Current (A)
 - P05.02, Induction Motor Rated Power (kW)
 - P05.03, Induction Motor Rated Speed (RPM)
 - P05.04, Induction Motor Pole Numbers
- 3) Set P05.00=1, named IM flux curve dynamic tuning and press the RUN key to get parameters P05.05 to P05.09 and weak flux parameters for sensorless. Please note that the motor will run in P05.00=1: Auto-tuning method.
- 4) Check the following parameters after IM flux curve dynamic tuning:
 - P05.05, IM No-load Current
 - P05.06, IM Stator Resistance
 - P05.07, IM Rotor Resistance
 - P05.08, IM Lm
 - P05.09, IM Lx
- 5) Set P05.00=12 to begin IM motor inertia auto-tuning.
 - Set P00.10=2, Torque mode
 - Set P05.00= 12, press RUN key to operate inertia estimation
 - Repeat to set P05.00= 12 for operating inertia estimation until P11.01 is stable.
- 6) Enable automatic ASR bandwidth adjustment.
 - Set P11.00= 1 to enable automatic ASR bandwidth adjustment. This allows P11.03 to P11.05 to make real ASR PI changes automatically based on the situation. This is more flexible for practical commissioning.
 - If P11.00=0, ASR bandwidth is not automatically adjusted and only P11.06 to P11.11 will be enabled. The ASR bandwidth will not adjust while running.
- 7) The following additional parameters may help fine tune the performance of your motor – adjust as needed:
 - P10.24, bit0, ASR control at TQC sensorless
 - P10.24, bit11, DC brake when executing zero torque command
 - P10.24, bit15, Direction limitation at TQC sensorless
 - P10.25, FOC bandwidth of speed observer (Hz). Setting this value higher can decrease the speed response time, but will create more noise interference.
 - P10.26, FOC minimum stator frequency. Set the minimum stator frequency in case the frequency command or limitation is too low.
 - P10.27, FOC low-pass filter time constant (ms). If the motor can't be activated during high-speed operation, decrease the value of P10.27.
 - P10.28, FOC gain of excitation current rise time (ms). If the drive's action time is too long in torque mode, decrease the value of P10.28.
 - P11.33, Source of torque command.
 - P11.34, Torque command.
 - P11.36, Speed limit selection.

TQC Sensorless Mode FAQ

- 1) Q: Can we use GS20 TQC sensorless mode to work smoothly in any situation?

A: It is dependent on load. GS20 TQC sensorless works smoothly at 3Hz and 10% torque, the minimum requirements. However, with a light load the GS20 can work smoothly even below 3Hz.

2) Q: What is the essence of the P10.26 function?

A: P10.26 is for minimum stator frequency. So if P10.26=10 and P01.00=50Hz, the minimum stator frequency is $P01.00 \times P10.26 / 100 = 5\text{Hz}$. When your frequency limitation is less than 5Hz, the output frequency will be at least 5Hz. Do not set P10.26 too high or too low as drive internal calculations have one stable range for successful operation. Typically it's best to use the default settings for P10.26 through P10.28.

3) Q: Why does the motor run when the speed limit is zero and the torque command is not zero?

A: GS20 TQC sensorless can't calculate accurately when the motor is working at very low speed. If the speed limit is zero, the motor will still run at about 3Hz due to internal drive calculations. Set P01.34=1 to use DC brake mode and the motor will be held when the speed limit is zero and torque command is not zero. However, the motor will run if the speed limit is above 3Hz to ensure smooth operation.

4) Q: How do I use the DC brake function when the torque command is zero?

A: When the torque command is zero, the motor should not output torque. However, in some special applications, even if the torque command is zero the motor needs to output zero speed torque to avoid load falling. In these instances, we can set bit11 of P10.24=0 (default) to enable the DC brake when the torque command is zero, but DC brake torque size is fixed by firmware and can't be adjusted. If bit11 of P10.24=1, no DC output will occur when torque command is zero and the GS20 will output one frequency based on P10.26.

- b) When you finish tuning, the following parameters are available:
- *P05.39: Stator resistance*
 - *P05.40: Permanent magnet synchronous AC motor L_d*
 - *P05.41: Permanent magnet synchronous AC motor I_q*
 - *P05.43: ($V / 1000 \text{ rpm}$), the K_e parameter of PM synchronous AC motor (you can calculate this automatically according to power, current, and speed of the motor).*
- 4) Set the speed control mode: P00.10 Control Mode = 0, P00.11 Speed Control Mode = 2 SVC.
 - 5) Cycle the power after you finish tuning.
 - 6) The ratio of the PMSVC control mode is 1:20.
 - 7) When the PMSVC control mode is under 1/20th of the rated speed, the load bearing capacity is 100% of the motor rated torque.
 - 8) PMSVC control mode is not applicable to zero speed control.
 - 9) The start-up load and the load bearing capacity of the forward/reverse running in PMSVC control mode equal to 100% of the motor rated torque.

10) Adjustment flow chart when starting WITHOUT load:

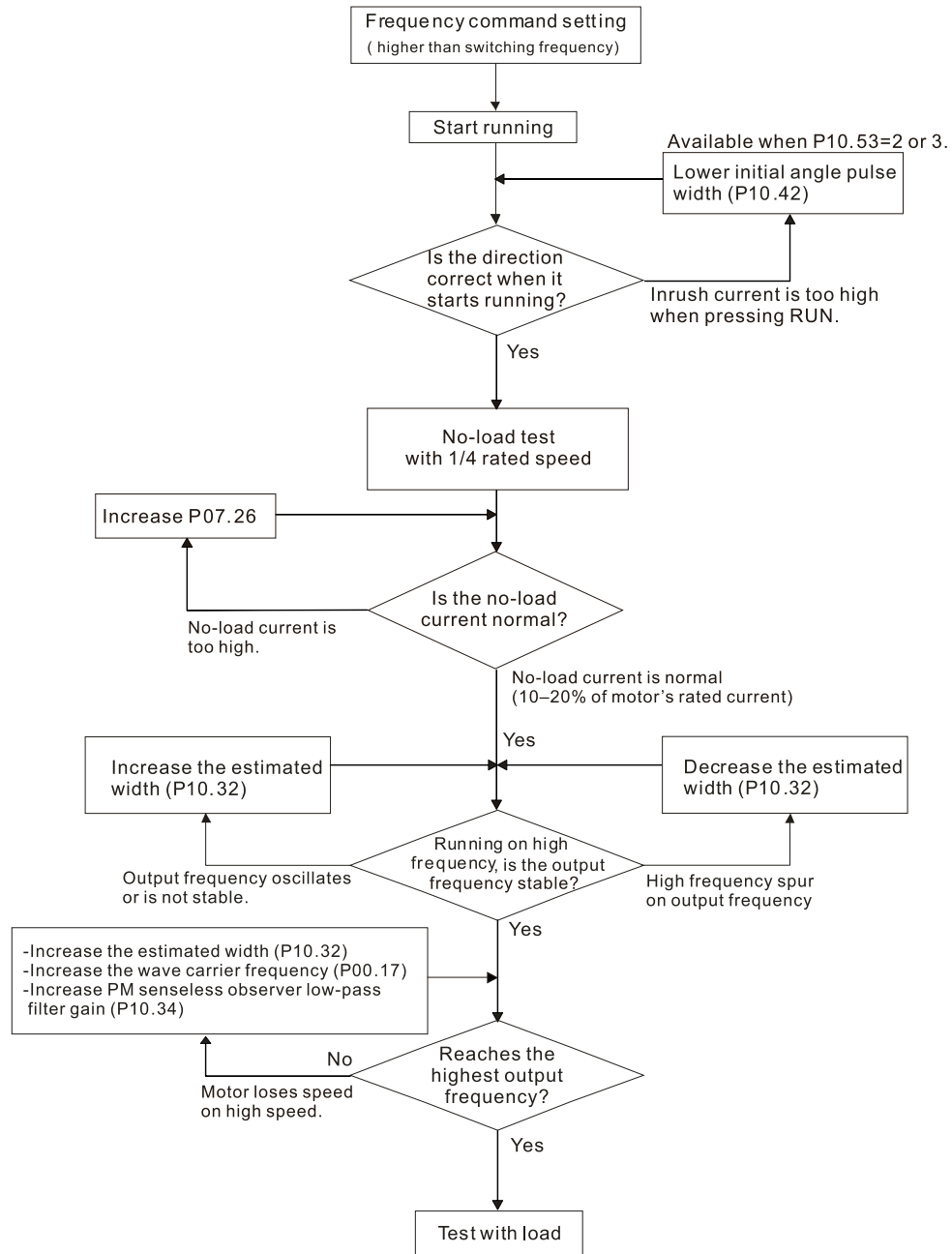

11) Adjustment flow chart when starting WITH load:

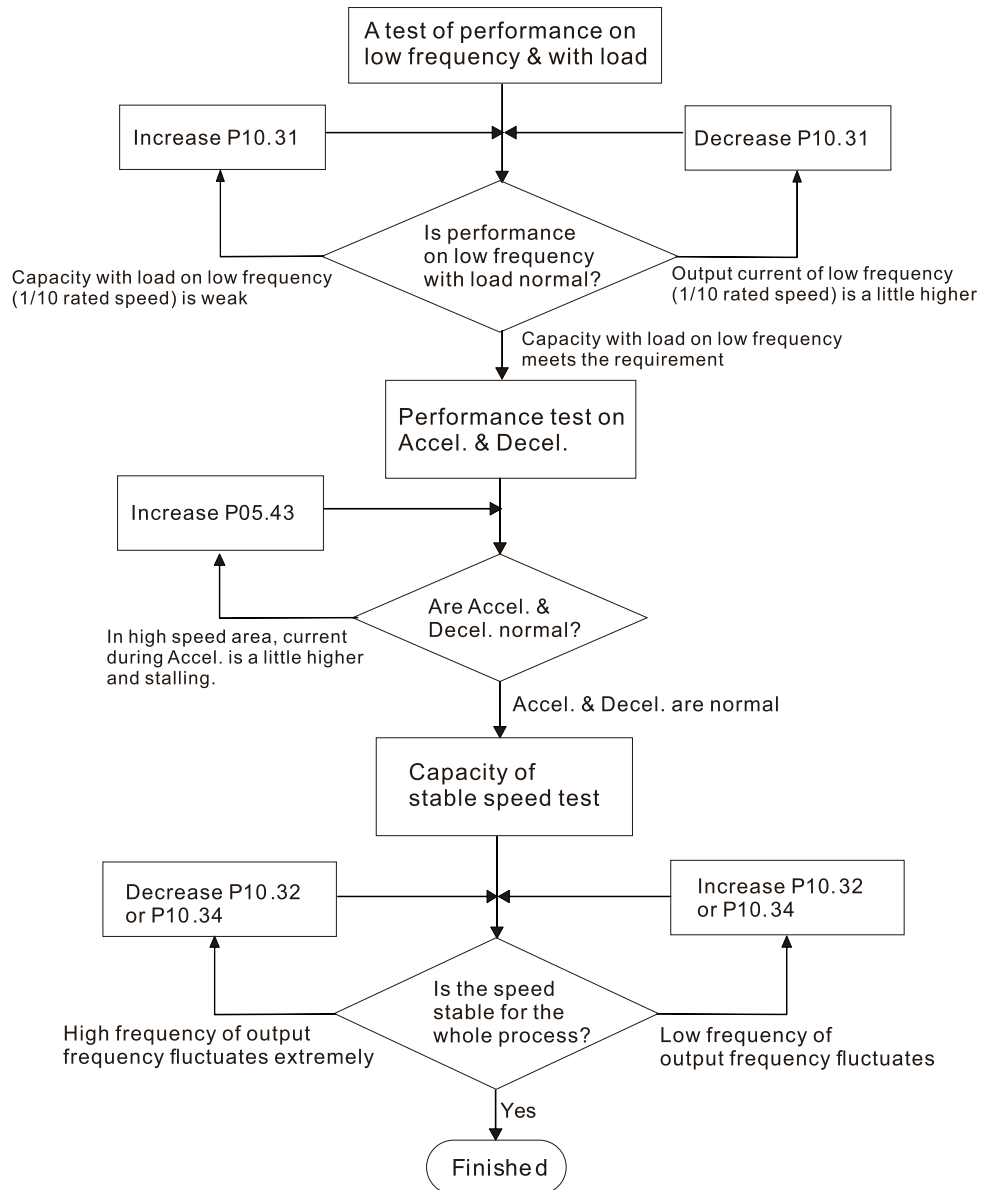

12) Set up the related parameters for speed estimators

- P10.31, I/F Mode, Current Command
- P10.32, PM FOC Sensorless Speed Estimator Bandwidth
- P10.34, PM Sensorless Speed Estimator Low-pass Filter Gain
- P10.39, Frequency Point to Switch from I/F Mode to PM Sensorless Mode
- P10.42, Initial Angle Detection Pulse Value
- P10.49, Zero Voltage Time during Start-up
- P10.51, Injection Frequency
- P10.52, Injection Magnitude
- P10.53, Angle Detection Method
- P07.26, Torque Compensation Gain

13) After PMSVC setup is complete, cycle power to the GS20(X) drive.

TORQUE CALCULATION AND TORQUE PARAMETER SETUP REFERENCE

DRIVE MOTOR TORQUE CALCULATION

Torque reference scaling is based on the motor rated torque, set by the Group 5 parameters. The Torque calculated value can be viewed in P00.04 = 39 which will be similar to the rated nameplate motor torque.

See an example for Motor Y360 below:

Calculation equation for the motor rated torque:

$$\text{Motor rated torque: } T(N.M) = \frac{P(W)}{\omega(\text{rad/s})}$$

Where:

P (W) value = P05.02

$$\omega(\text{rad/s}) \text{ value} = \frac{P5.03 \times 2\pi}{60} = \text{rad/s}$$

- 1) Set the motor nameplate data in the Group 5 parameters. See example for Marathon Motor Y360 below:

MOTOR NAMEPLATE DATA

Motor	Torque	Current	Power	Speed
Part No	N-m	Amps	kW	RPM
Y360	1.5	1.8	0.37	1725

SET MOTOR PARAMETERS

Parameter	Description	Parameter Value
P05.01	IM1, FLA	1.8
P05.02	IM1 Power (kW)	0.37
P05.03	IM1 Speed (rpm)	1725

$$T(N.m) = \frac{P5.02 \times 1000}{\left(\frac{P5.03 \times 2 \times 3.14}{60}\right)} = \frac{0.37 \times 1000}{\left(\frac{1725 \times 2 \times 3.14}{60}\right)} = 2.0$$

- 2) Set P11.27, Max Torque Command, to scale the upper limit of the torque command. The value can be 0–500%.
 - P11.27 = 100% . . . this corresponds to the 2 N·m result from the step above.

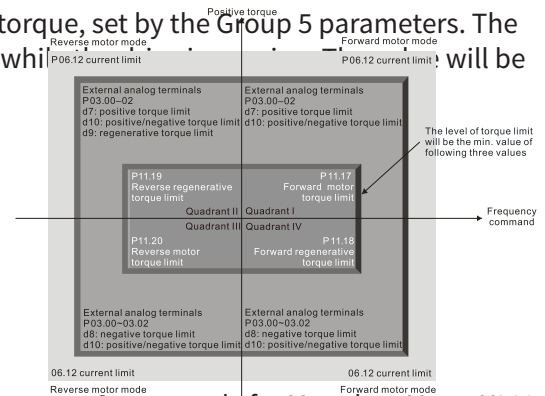

GS20 DRIVE - TORQUE LIMIT IN SPEED MODE DETAILED EXPLANATION

Torque limit is controlled in 2 ways:

- 1) Parameter control: P11.17–P11.20

P11.17	Forward Motor Torque Limit
P11.18	Forward Regenerative Torque Limit
P11.19	Reverse Motor Torque Limit
P11.20	Reverse Regenerative Torque Limit
<i>Range/Units (Format: 16-bit unsigned)</i>	
0–500%	

- 2) Analog input control: P03.00 or P03.01 = 7, 8, 9, or 10

P03.00	Analog input selection (AI1)	0: No function 1: Frequency command 2: Torque command (torque limit under speed mode) 3: Torque compensation command 4: PID target value 5: PID feedback signal 6: Thermistor (PTC) input value
P03.01	Analog input selection (AI2)	7: Positive torque limit 8: Negative torque limit 9: Regenerative torque limit 10: Positive / negative torque limit 11: PT100 thermistor input value 12: Auxiliary frequency input 13: PID compensation value

These settings are based on MOTOR RATED TORQUE = 100%. The settings for P11.17–P11.20 compare with the P03.00 = 7, 8, 9, 10 in the torque limit block. The minimum value of the comparison result is the torque limit.



NOTE: The total drive current limit is governed by P06.12. This parameter is to protect the drive (0 -250% of Drive Rated Current). If either P11.17-20 or Analog input torque limit exceeds P06.12, the speed of the drive will be reduced until the current is under this limit.

P06.12 is the only current/torque limit available for V/F, VFPG, IMSVC or PMSVC modes (P00.11 = 0, 1,2).

P06.12	Current limit	0–250% (100% corresponds to the rated current of the drive)
---------------	---------------	--

SPEED MODE WITH TORQUE LIMITS VIA ANALOG INPUT

While in Speed mode and controlling torque limits via an analog input, use the following parameter configuration.



NOTE: Only P00.11=5 IMFOC speed mode can be used with torque limits.

Set parameters as follows:

- 1) Set Control Modes:

Parameter	Parameter Description	Parameter Value
P00.10	Control Method	0 (Speed)
P00.11	Speed (Velocity) Control Mode	5 (IMFOC)

- 2) Set up motor values for calculation of proper torque:

Parameter	Parameter Description	Parameter Value
P05.01	Induction Motor 1, Full-load amps	10-120% drive current
P05.02	Induction Motor 1, Rated power (kW)	Set based on motor. This is used to calculate Torque Cmd value
P05.03	Induction Motor 1, Rated speed (rpm)	Set based on motor. This is used to calculate Torque Cmd value

- 3) Tune Motor

Parameter	Parameter Description	Parameter Value
P05.00	1	Press Run and allow Auto-Tune

- 4) Set up User display to monitor the torque of the drive. This is optional but will help you see what the drive is doing to limit the torque.

Parameter	Parameter Description	Parameter Value
P00.04	User Display	8 = % Torque or 39 = Torque Netwon - Meters

- 5) Set up Analog Input command signal.

Parameter	Parameter Description	Parameter Value
P03.00 or P03.01	Analog input selection	7-10 - Torque limits When using this selection, the corresponding value for 0-10 V / 4-20 mA is 0 – maximum output torque (P11.27).

- 6) Set up the maximum torque value for the torque command.

Parameter	Parameter Description	Parameter Value
P11.27	Maximum Torque Command	0-500% (of Motor Rated Torque)

- 7) Set up the torque limits for the torque command.

Parameter	Parameter Description	Parameter Value
P11.17	Forward motor torque limit	500%
P11.18	Forward regenerative torque limit	500%
P11.19	Reverse motor torque limit	500%
P11.20	Reverse regenerative torque limit	500%

- 8) Ensure the drive current limit will not interfere with torque command limits

Parameter	Parameter Description	Parameter Value
P06.12	Current limit	0-250% drive current. Ensure this value is set above the motor torque requirements or it will prevent full torque to the motor

GS20 DRIVE QUICK REFERENCE- ALTERNATING BETWEEN TORQUE AND SPEED MODE

The drive allows alternating between Torque and Speed mode via a digital input. **A multifunction input must be set to 26 for the use of P03.00 / P03.01 = 2** as the torque limit function.

Set parameters according to the steps below to use analog input control of torque and frequency while in this mode.

- 1) Set Control Modes:

Parameter	Parameter Description	Parameter Value
P00.10	Control Method	0 (Speed) or 2 (Torque)
P00.11	Speed (Velocity) Control Mode	5 (IMFOC)

- 2) Set up motor values for calculation of proper torque:

Parameter	Parameter Description	Parameter Value
P05.01	Induction Motor 1, Full-load amps	10-120% drive current
P05.02	Induction Motor 1, Rated power (kW)	Set based on motor. This is used to calculate Torque Cmd value
P05.03	Induction Motor 1, Rated speed (rpm)	Set based on motor. This is used to calculate Torque Cmd value

- 3) Tune Motor

Parameter	Parameter Description	Parameter Value
P05.00	1	Press Run and allow Auto-Tune

- 4) Set up User display to monitor the torque of the drive. This is optional but will help you see what the drive is doing to limit the torque.

Parameter	Parameter Description	Parameter Value
P00.04	User Display	8 = % Torque or 39 = Torque Netwon - Meters

- 5) Set up one digital input selection of control mode.

Parameter	Parameter Description	Parameter Value
P02.01–P02.07	Digital input config	26 (Dlx=1 TQC Torque mode, Dlx=0 IMFOC Speed Mode) NOTE: If P00.10 = 0...when Speed mode is enabled (Dlx=0), the torque limit will be held at the last value used while in torque mode. If P00.10=2, when Speed mode is enabled (Dlx=0), the torque limit follows the value of the configured analog input in real time.

- 6) Set up Analog Input command signal.

Parameter	Parameter Description	Parameter Value
P03.00 or P03.01	Analog input selection	2 - Torque command (torque limit under speed mode) When using this selection, the corresponding value for 0–10 V / 4–20 mA is 0–maximum output torque (P11.27). When Dlx=1: AI functions as Torque Command. When Dlx=0: AI functions as Torque Limit. Speed command is determined by P00.20.

- 7) Set up the Analog input as the torque command source.

Parameter	Parameter Description	Parameter Value
P11.33	Torque command source	2 – Analog Signal Input

- 8) Set up the maximum torque value for the torque command.

Parameter	Parameter Description	Parameter Value
P11.27	Maximum Torque Command	0-500% (of Motor Rated Torque)

- 9) Set up the torque limits for the torque command.

Parameter	Parameter Description	Parameter Value
P11.17	Forward motor torque limit	500%
P11.18	Forward regenerative torque limit	500%
P11.19	Reverse motor torque limit	500%
P11.20	Reverse regenerative torque limit	500%

- 10) Ensure the drive current limit will not interfere with torque command limits

Parameter	Parameter Description	Parameter Value
P06.12	Current limit	0-250% drive current. Ensure this value is set above the motor torque requirements or it will prevent full torque to the motor

BLANK
PAGE