

OPT2026, OPT2027, OPT2028, OPT2029

Print Mark Sensor



Operating Instructions

Index

1. Proper Use	3
2. Safety Precautions	3
3. EU Declaration of Conformity	3
4. Technical Data	4
5. Installation Instructions	6
6. Initial Start-Up	7
7. Functional Overview	7
7.1. Setting the Switching Threshold with the Teach-In Function.....	7
7.2. Checking for Correct Function	9
7.3. Readjusting the Switching Threshold with the Potentiometer Function.....	10
7.4. Approximating the Switching Threshold to the background.....	10
7.5. Delay Times: On and Off-Delay.....	10
7.6. Trigger Function at Pin 5	11
7.7. Resetting All Sensor Settings to their Default Values	12
8. Maintenance Instructions	12
9. Proper Disposal	12

1. Proper Use

This wenglor product has to be used according to the following functional principle:

Print Mark Sensors

Print mark readers operate using a white light LED with a long service life, and produces a very small light spot. All brightness and color combinations between the print mark and the background are detected using only one sensor.

2. Safety Precautions

- This operating instruction is part of the product and must be kept during its entire service life.
- Read this operating instruction carefully before using the product.
- Installation, start-up and maintenance of this product has only to be carried out by trained personal.
- Tampering with or modifying the product is not permissible.
- Protect the product against contamination during start-up.
- Not a safety component in accordance with the EU Machinery Directive.

3. EU Declaration of Conformity

The EU declaration of conformity can be found on our website at www.wenglor.com in download area.



RoHS

4. Technical Data

Optical Data	OPT2026, OPT2027	OPT2028, OPT2029
Working Range	12...16 mm	30...40 mm
Working Distance	14 mm	35 mm
Resolution	100 Gray Scale	100 Gray Scale
Switching Hysteresis	< 1 %	< 1 %
Light Source	White Light	White Light
Wave Length	400...700 nm	400...700 nm
Service Life (Tu = 25 °C)	100000 h	100000 h
max. Ambient Light	10000 Lux	10000 Lux
Light Spot Size a (a × b)	0,7 mm	1,4 mm
Light Spot Size b (a × b)	2 mm	4 mm

Electrical Data		
Supply Voltage	10...30 V DC	10...30 V
Current Consumption (Ub=24 V)	<50 mA	< 50 mA
Switching Frequency	25 kHz	25 kHz
Response Time	20 μs	20 μs
On-/Off-Delay	0...100 ms	0...100 ms
Temperature Drift	< 1 %	< 1 %
Temperature Range	-25...60 °C	-25...60 °C
Switching Outputs	2	2
Switching Output Voltage Drop	1,5 V	1,5 V
Short Circuit Protection	yes	yes
Reverse Polarity Protection	yes	yes
Lockable	yes	yes
Teach Mode	ZT, DT, TP	ZT, DT, TP
Digital Inputs	2	2

Mechanical Data		
Adjustment	Teach-In	Teach-In
Housing	Plastic	Plastic
Protection Mode	IP67	IP67
Connection	M12 × 1	M12 × 1
Protection Class	III	III

Connection Diagram

OPT2026
OPT2028

168

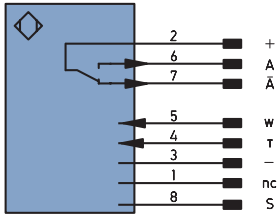

OPT2027
OPT2029

356

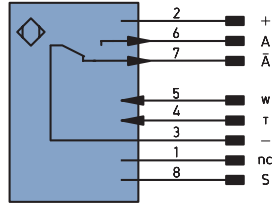

- + Supply Voltage +
- A Switching Output (NO)
- A̅ Switching Output (NC)
- W Trigger Input
- T Teach-in-Input
- S Shielding
- Supply Voltage 0 V
- nc not connected

Housing Dimensions

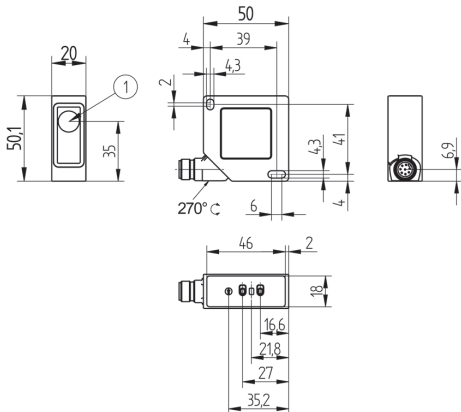

1 = optical axle

Control Panel

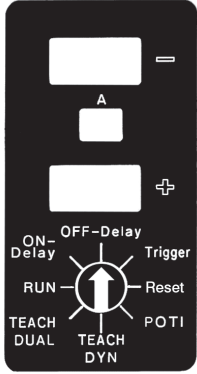

- | | |
|--------------|-----------------------------------|
| ❶ - | = Minus key (with LED) |
| ❷ A | = Output switching status display |
| ❸ + | = Plus key (with LED) |
| ❹ ON-Delay | = On-delay |
| ❺ OFF-Delay | = Off-delay |
| ❻ Trigger | = Trigger mode operation |
| ❼ Reset | = Reset function |
| ❽ TEACH DUAL | = Two-point Teach-In |
| ❾ TEACH DYN | = Dynamic Teach-In |
| ❿ POTI | = Potentiometer function |
| ⓫ RUN | = Run function |
| ⓬ | = Rotary selector switch |

5. Installation Instructions

Applicable electrical and mechanical regulations, standards and safety precautions must be adhered to during Sensor operation. The Sensor must be protected against mechanical influences. The Sensor must be securely mounted during operation.

The sensor is aligned parallel to the print mark.

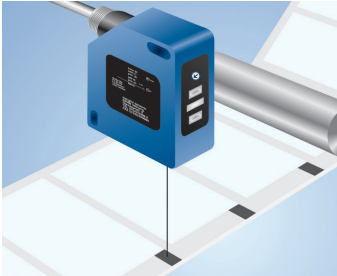

Mounting for glossy objects:

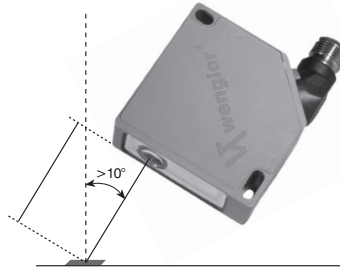

6. Initial Start-Up

Connect the Sensor to supply power (10 to 30 V DC).

7. Functional Overview

7.1. Setting the Switching Threshold with the Teach-In Function

With the help of the integrated Teach-In technology, the Sensor automatically calculates setting values based upon currently acquired values and saves them to memory after the corresponding key has been activated, or a control signal has been received.

Two-Point Teach-In

Two grey-scale values are taught in to the Sensor: the grey-scale value of the marking to be recognized and the grey-scale value of the background. The Sensor then automatically calculates the ideal switching threshold based upon these two values.

The brightness relationship of the two grey-scale values is irrelevant as far as switching characteristics are concerned. Sensor output A is activated when the Sensor recognizes the grey-scale value which was taught in first. Sensor output A is deactivated when the Sensor recognizes the grey-scale value which was taught in second.

Teach in the first grey-scale value:

- Set the rotary selector switch ① to TEACH DUAL ②
- Align the Sensor spot to the marking
- Press and hold the plus key ③
 - The LED at the plus key lights up
 - The LED at the plus key goes out after 1 s, and the output switching status display ④ blinks.
- Release the plus key ③
 - The LED at the minus key blinks
 - The grey-scale value of the marking is saved to temporary memory

Teach in the second grey-scale value:

- Align the Sensor spot to the background
- Briefly press the minus key ① and then release
 - The switching threshold is calculated and saved to memory
 - The LED at the minus key goes out
- Check for correct function

If the difference between the two acquired grey-scale values is too small, the output switching status display ④ blinks rapidly for approximately 3 seconds, and switching thresholds are not updated.

Dynamic Teach-In

All grey-scale values from the background and the marking are continuously recorded with this function. The ideal switching threshold is calculated based upon these values.

This function is intended for applications where the objects to be scanned move continuously at a constant speed, and cannot be brought to a standstill within the production process.

Example 1

Recognition of adhesive strips on unprinted packaging material, which is fed in a continuous fashion: when Teach-In operation is initialized, the spot must be aligned to the background.

Example 2

Recognition of printed markings on rapidly rotating parts: dynamic Teach-In operation can be initialized regardless of spot alignment.

Initialize recording mode operation:

- Set the rotary selector switch **1** to TEACH DYN **2**
- Press and hold the plus key **3**
 - The LED at the plus key lights up
 - The LED at the plus key goes out after 1 s, and the output switching status display **2** blinks.
- Release the plus key
 - The LED at the minus key blinks: recording mode operation is active
 - Grey-scale values are continuously recorded

Exit recording mode operation:

- Briefly press the minus key **1** and then release
 - Recording is stopped
 - The switching threshold is calculated and saved to memory
- Check for correct function

If the difference between the two acquired grey-scale values is too small, the output switching status display **2** blinks rapidly for approximately 3 seconds, and switching thresholds are not updated.

External Teach-In

If the control panel is inaccessible, the Sensor can be configured with the external Teach-In input (pin 4). The last Teach-In mode selected at the control panel is always active (i.e. two-point or dynamic Teach-In).

Notice

Use of the external Teach-Input (Pin 4):

If you use the external Teach-Input (Pin 4) you have to connect a 1 kOhm/1 W-resistor between Pin 4 (external Teach-Input) and Pin 3 (GND).

External Two-Point Teach-In

Teach in the first grey-scale value:

- Set the rotary selector switch **1** to RUN **2**
- Apply a voltage of 10 to 30 V to external Teach-In input T (pin 4) for at least 0,3 s
- Disconnect voltage from external Teach-In input T (pin 4)
 - The LED at the minus key blinks
 - The grey-scale value of the marking is saved to temporary memory.

Teach in the second grey-scale value:

- Align the Sensor spot to the background.
- Apply a voltage of 10 to 30 V to external Teach-In input T (pin 4) for at least 0,3 s.

- Disconnect voltage from external Teach-In input T (pin 4).
 - The switching threshold is calculated and saved to memory.
 - The LED at the minus key goes out.
- Check for correct function.



If the difference between the two acquired grey-scale values is too small, the output switching status display  blinks rapidly for approximately 3 seconds, and switching thresholds are not updated.

External Dynamic Teach-In

Objects to be scanned move at a constant speed.

If no continuous alternating back and forth between the marking and the background occurs during recording, the spot must be aligned to the background when the Teach-In mode is first initialized.

Initialise recording mode operation:

- Set the rotary selector switch  to RUN 
- Apply a voltage of 10 to 30 V to external Teach-In input T (pin 4) for at least 0,3 s
- Disconnect voltage from external Teach-In input T (pin 4)
 - The LED at the minus key blinks: recording mode operation is active
 - Grey-scale values are continuously recorded

Exit recording mode operation:

- Apply a voltage of 10 to 30 V to external Teach-In input T (pin 4) for at least 0,3 s
- Disconnect voltage from external Teach-In input T (pin 4)
 - Recording is stopped
 - The switching threshold is calculated and saved to memory
- Check for correct function

If the difference between the two acquired grey-scale values is too small, the output switching status display  blinks rapidly for approximately 3 seconds, and switching thresholds are not updated.

7.2. Checking for Correct Function

- Move the object to be scanned.
 - Sensor output A is activated when the spot is aligned to the marking.
 - Sensor output A is deactivated when the spot is aligned to the background.
- Readjust the switching threshold with the potentiometer function if the Sensor does not respond correctly.

7.3. Readjusting the Switching Threshold with the Potentiometer Function

The switching threshold can be manually readjusted with the help of a key potentiometer. The LEDs at the plus and minus keys function as a light scale, and indicate the grey-scale range within which the configured switching threshold lies. For example, if the LED at the minus key is brighter than the LED at the plus key, the switching threshold is set to a darker grey-scale value. If the LED at the plus key is brighter than the LED at the minus key, the switching threshold is set to a brighter grey-scale value.

If the LED at the plus key blinks, the switching threshold is set within the brightest grey-scale range. If the LED at the minus key blinks, the switching threshold is set within the darkest grey-scale range.

Approximating the Switching Threshold to the marking

- Set the rotary selector switch **⌚** to POT1 **⌚**
- Briefly press the plus key **➕** and then release
 - ➔ The switching threshold is approximated to the marking by one step, or
 - ➔ Press and hold the plus key **➕**
 - ➔ The switching threshold is continuously approximated to the marking
- Check for correct function

7.4. Approximating the Switching Threshold to the background

- Set the rotary selector switch **⌚** to POT1 **⌚**
- Briefly press the minus key **➖** and then release
 - ➔ The switching threshold is approximated to the background by one step, or
 - ➔ Press and hold the minus key **➖**
 - ➔ The switching threshold is continuously approximated to the background
- Check for correct function

7.5. Delay Times: On and Off-Delay

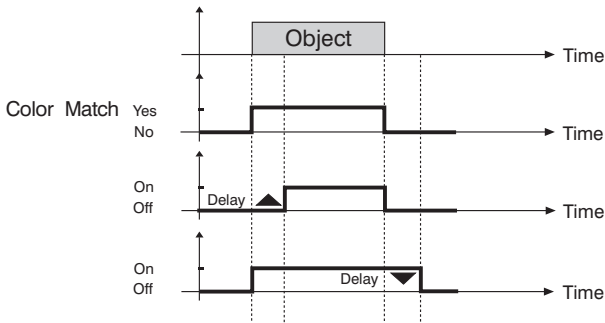

Adjusting On-Delay

- Set the rotary selector switch **⌚** to On-Delay **Ⓔ**
→ Current on-delay is displayed (see table 1).
- Briefly press the plus key **⊕**
→ On-delay is increased.
- Briefly press the minus key **⊖**
→ On-delay is decreased.
- Set the rotary selector switch **⌚** to RUN **Ⓘ**

Adjusting Off-Delay

- Set the rotary selector switch **⌚** to Off-Delay **Ⓢ**
→ Current off-delay is displayed (see table 1).
- Briefly press the plus key **⊕**
→ Off-delay is increased.
- Briefly press the minus key **⊖**
→ Off-delay is decreased.
- Set the rotary selector switch **⌚** to RUN **Ⓘ**

Delay Time Setting Displays

Delay	LED at Minus Key ⊖	LED at Plus Key ⊕
0 ms*	1 × blink, pause, 1 × blink	off
1 ms	2 × blinks, pause, 2 × blinks	off
2 ms	3 × blinks, pause, 3 × blinks	off
5 ms	4 × blinks, pause, 4 × blinks	off
10 ms	off	1 × blink, pause, 1 × blink
20 ms	off	2 × blinks, pause, 2 × blinks
50 ms	off	3 × blinks, pause, 3 × blinks
100 ms	off	4 × blinks, pause, 4 × blinks





*Default setting

7.6. Trigger Function at Pin 5

- Set the rotary selector switch **⌚** to Trigger **Ⓢ**
- Apply the trigger signal (PNP) to input W (pin 5)
→ Triggering is executed with a positive signal edge
→ The Sensor performs a one-time measurement
→ The outputs are updated once only
- Disconnect the signal from the trigger input

7.7. Resetting All Sensor Settings to their Default Values

Sensor settings can be returned to their original factory default values.

- Set the rotary selector switch  to Reset 
- Simultaneously press the plus  and minus  keys.
 - ➔ The LEDs at both keys start blinking.
 - ➔ The LEDs stop blinking after approximately 5 seconds
- Release both keys
- The Sensor has been returned to its factory default settings

8. Maintenance Instructions

- This wenglor Sensor is maintenance-free.
- It is advisable to clean the lens and the display, and to check the plug connections at regular intervals.
- Do not clean with solvents or cleansers which could damage the device.

9. Proper Disposal

wenglor sensoric GmbH does not accept the return of unusable or irreparable products. Respectively valid national waste disposal regulations apply to product disposal.

