

Installation and Specifications

In This Chapter. . . .

- Connecting a Power Supply
 - Preparing Panel for Configuration
 - Preparing Panel for Communications
 - OP-9001 Multi-panel Configurations
 - Choosing Connecting Cables
 - Connecting Cable Details
 - Labeling the Lamps and Pushbuttons
 - Templates for Manually Creating labels
 - Dimensions for Mounting
 - Panel Specifications
-

Connecting a Power Supply

Power Supply Connections

An external power supply is adapted to supply operating voltage to the OP-640 unit. The power supply must deliver a range between 8 to 30 VDC, and provide a minimum of 5 watts continuous power to the units. Connect your power supply using the terminal block connector supplied with each panel. The connector is keyed to prevent reversing the polarity.

Use 18-24 AWG conductor wire and connect the power supply to the connector block which is supplied with each operator panel. The terminal marked 1 is the positive (+8-30 VDC) connection and terminal 2 is the common ground (0V) connection.

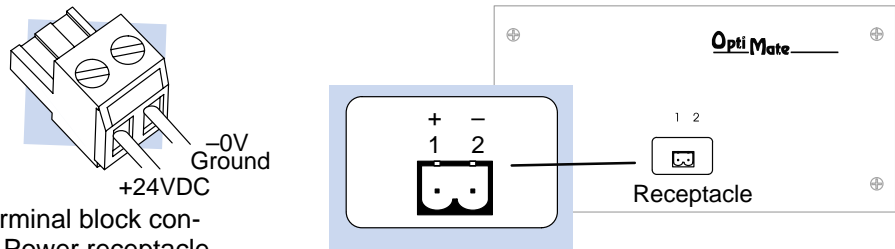

Plug the terminal block connector into Power receptacle located on the back side of the panel.

Multi-panel Power Supply Connection

In Multi-panel applications, if separate power supplies are used, make sure the electrical ground connections do not have a great potential difference. When using a single power supply in a Multi-panel application, the power supply must maintain the specified voltage and current consumption levels under all conditions (including power-up) for each of the individual units. See individual panel power requirements under Panel Specifications.

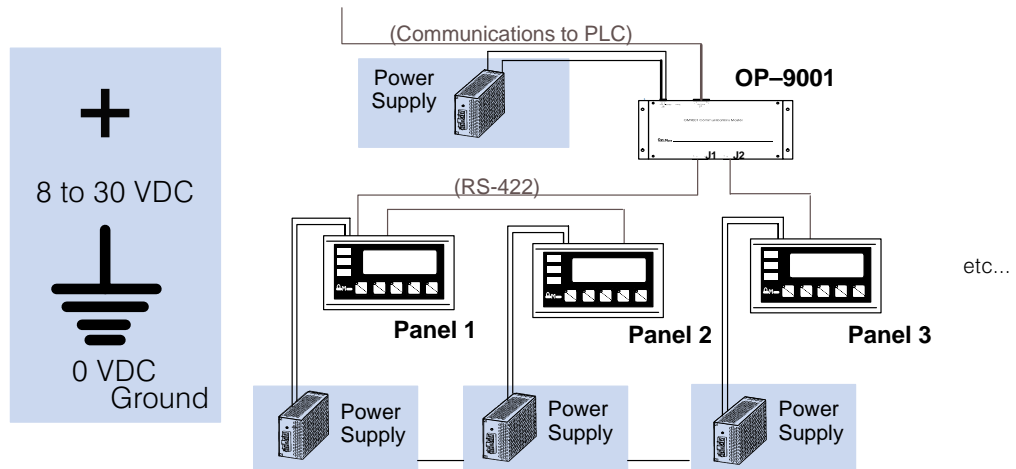

Preparing the Panel for Configuration

RUN/PGM Switch

The RUN/PGM Switch must be set to PGM (ON) before downloading from the PC to the panel. The TERM switch should remain off.



NOTE: You must cycle power to the panel to activate the new switch settings.

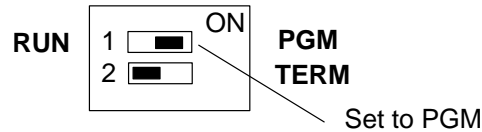

Configuration Cable

Connect the configuration cable (OP-ACBL-1) between the serial port of the OP-panel and the serial port of the personal computer. The panel may then be configured using the OP-WINEDIT configuration software. The figure below shows programming cable connectors and wiring specifications. Wiring diagrams refer to the cable connectors, *not* the communication ports.

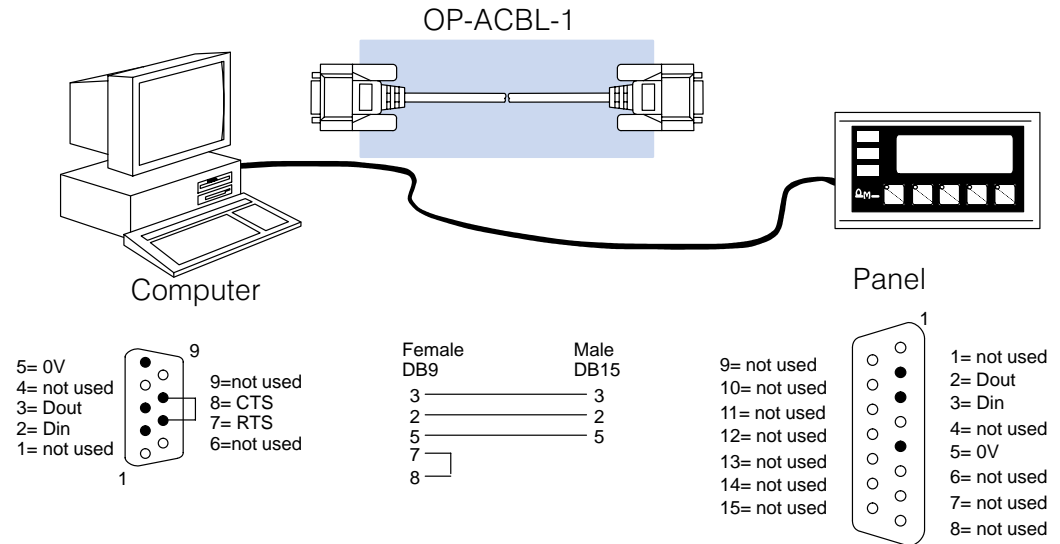

Preparing the Panel for Communications

RUN/PGM Switch

The RUN/PGM Switch must be set to **RUN** after loading the configuration program. The TERM switch should remain off.



NOTE: You must cycle power to the panel to activate the new switch settings.

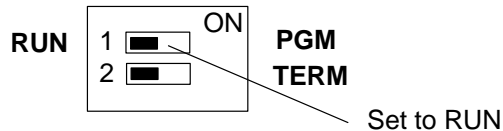

OP-9001 Multi-Panel Configurations

If you are connecting more than one OptiMate panel to a single CPU this is referred to as Multi-panel configuration. Multi-panel configurations require the OP-9001 Communications Master. The OP-9001 communicates with the CPU as well as the connected OP-panels. The OP-9001 looks for an address within the range of 0 to 30 for each panel connected. Each panel connected in an RS-422 link must have a unique address. A more detailed description of multiple panel configurations and installation is given in the OP-9001-M User Manual.

The TERM Switch

When using an RS-422 communications link, the *last panel* must be terminated by setting the TERM Switch to ON. Systems which are using the OP-9001 in a multi-panel application use RS-422 wiring. Operator panels communicating more than 50 feet distance *must* use RS-422 links. The TERM Switch stays OFF for RS-232 communications.



NOTE: Only the *last panel* of each RS-422 link should be terminated (TERM switch ON). All other panels must have the TERM switch OFF. After changing the DIP switch settings, remember to cycle power on the panel to activate the new switch settings.

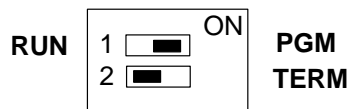

Choosing Connecting Cables

Depending on which PLC you are using, you may require as many as two cables. Here are the requirements:

- **OP-ACBL-1:** *all* units require this cable for configuration. This is a 9-pin female to 15-pin male cable that connects your personal computer to the OP-panel. This cable is also used to connect an OP-panel to the Allen-Bradley SLC 500 CPUs.
- **CPU Cables:** You will also need the appropriate cable to connect your CPU to the OP-panel. Use the chart shown to the right to choose the correct communications cable.

OP-9001 Cable Connectors

If you're planning to use multiple panels and an OP-9001, then you'll need to build your own custom cables. Since the proper cable choice really depends on your application, we offer the following connectors.

- **OP-CMCON-1** — pack of 4 ribbon cable connectors.
- **OP-CMCON-2** — pack of 4 solder-type connectors.
- **OP-CMCON-3** — pack of 2 D-shell connectors with screw terminals for use with OP-9001 & multiple OP-panels.
- **OP-PSCON** — pack of 4 power supply block connectors.

For electrically noisy environments, we recommend an individually paired and shielded cable, such as Belden 9729 or equivalent. This type of cable will require the solder-type or D-shell with screw terminal connectors. If you're going 30 feet or less, you can use ribbon cable. For ribbon cable, we recommend Belden 9L28015 or 3M 3365/15.

OptiMate Cables			
Family	CPU (or other device)	Port	Cable
DirectLOGIC-DL05 / DL105	DL05: D0-05	DL05: Both ports	OP-2CBL
	DL105: DL130	DL105: Only one port	
DirectLOGIC-DL205	DL230	Only port	OP-2CBL
	DL240	Top port	OP-2CBL
		Bottom port	OP-2CBL
	DL250	Top port	OP-2CBL
		Bottom port	OP-2CBL-1
D2-DCM (module)	Only port	OP-4CBL-2	
DirectLOGIC-DL305	DL330	Requires DCU*	OP-4CBL-2
	DL330P	Requires DCU*	OP-4CBL-2
	DL340	Top port	OP-3CBL
		Bottom port	OP-3CBL
	DL350	Top port	OP-2CBL
Bottom port		OP-4CBL-2	
DirectLOGIC-DL405	DL430	Top port (15-pin)	OP-4CBL-1
		Bottom port (25-pin)	OP-4CBL-2
	DL440**	Top port	OP-4CBL-1
		Bottom port	OP-4CBL-2
	DL450**	Phone Jack	OP-2CBL
		Top port (15-pin)	OP-4CBL-1
		Bottom port (25-pin)	OP-4CBL-2
	D4-DCM (module)	Only port	OP-4CBL-2
Slice I/O panels	Only port	OP-4CBL-1	
GE® Series 1	IC610CPU105/106	Requires DCU*	OP-4CBL-2
TI305™ / SIMATIC® TI305-	325-07, PPX:325-07	Requires DCU*	OP-4CBL-2
	330-37, PPX:330-37	Requires DCU*	OP-4CBL-2
	325S-07 (or 325 w/ Stage Kt)	Requires DCU*	OP-4CBL-2
	330S-37, PPX:330S-37	Requires DCU*	OP-4CBL-2
	335-37, PPX:335-37	Phone Jacks If DCU is used*	OP-3CBL OP-4CBL-2
TI405- / SIMATIC® TI405-	425-CPU, PPX:425-CPU **	Only port	OP-4CBL-1
	PPX:430-CPU	Top port (15-pin)	OP-4CBL-1
		Bottom port (25-pin)	OP-4CBL-2
	435-CPU, PPX:435-CPU **	Top port (15-pin)	OP-4CBL-1
		Bottom port (25-pin)	OP-4CBL-2
Smart Slice- I/O panels	Only port	OP-4CBL-1	
A-B SLC 500	5/03, 5/04	Bottom port	OP-ACBL-1
A-B	MicroLogix	Only port	OP-ACBL-2

* — requires RS232 Data Communications Unit (D3-232-DCU)

** — also available in DC versions

Connecting Cable Details

Connecting Cable The OP-640 connecting cable may vary depending on the CPU used. Refer to the previous page to confirm the proper cable is chosen for connecting to your PLC.

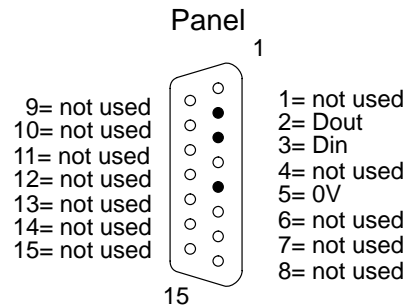
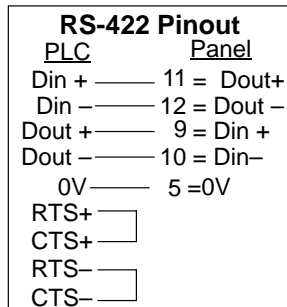
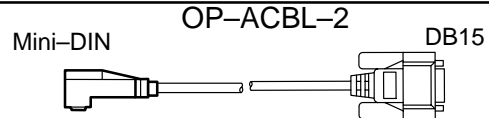
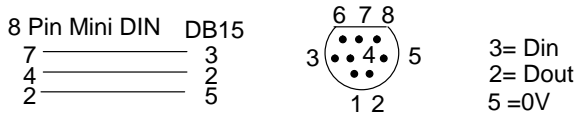
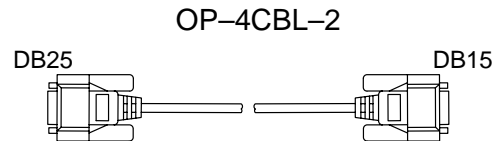
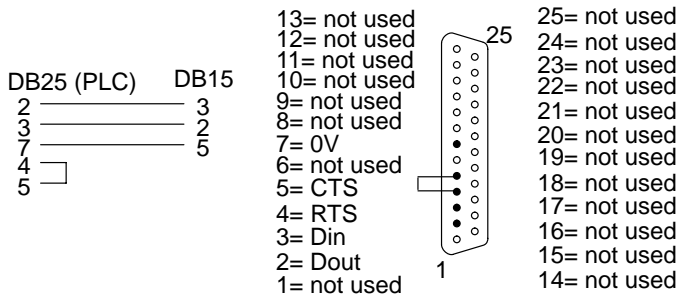
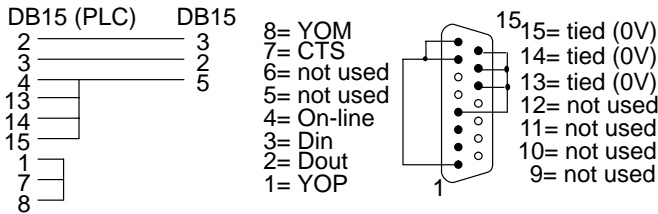
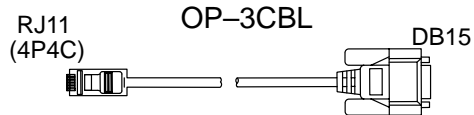
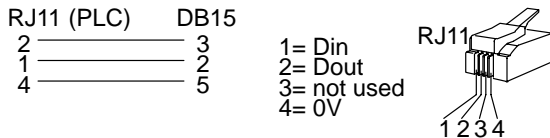
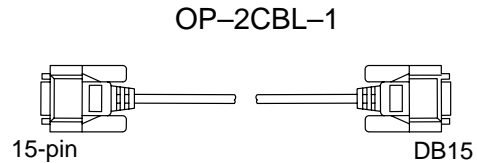
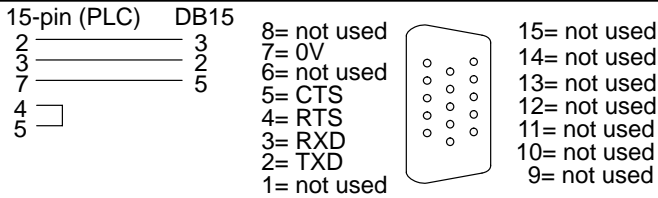
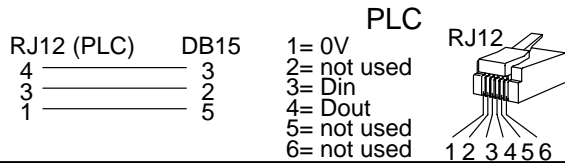

Installation and Specifications

Labeling the Lamps and Pushbuttons

Labeling the Lamps and Pushbuttons

In any manufacturing environment it is important to have legible labels on the pushbuttons. Labeling the OP-640 panel is a relatively simple process that involves removing the bezel and sliding a label transparency into a pocket in the panel overlay. The transparent film can be purchased from almost any office supply store in standard 8-1/2" x 11" sheets. It is designed to run through a copy machine or laser printer.



Creating the Labels

The easiest way to create labels is to use the built-in label making function of the OP-WINEDIT configuration software. This is the preferred method and is shown below. The labels can also be created manually using the template shown in the next section to help layout the transparency film. Here are some ways of manually creating labels:

- Use a computer graphics program and a laser printer to create the transparency directly, or print the labels on paper and photocopy them to a transparency sheet.
- Use press-on letters on a transparency sheet.
- Use a typewriter or lettering machine, or use press-on letters to create labels on a paper sheet, then photocopy the paper sheet onto a transparency sheet.

Creating Labels Using OP-WINEDIT

Making labels using the OP-WINEDIT configuration software is easy (see Chapter 4 for information on loading and using OP-WINEDIT). After loading OP-WINEDIT, follow these steps:



1. Open OP-WINEDIT and select **New System**.

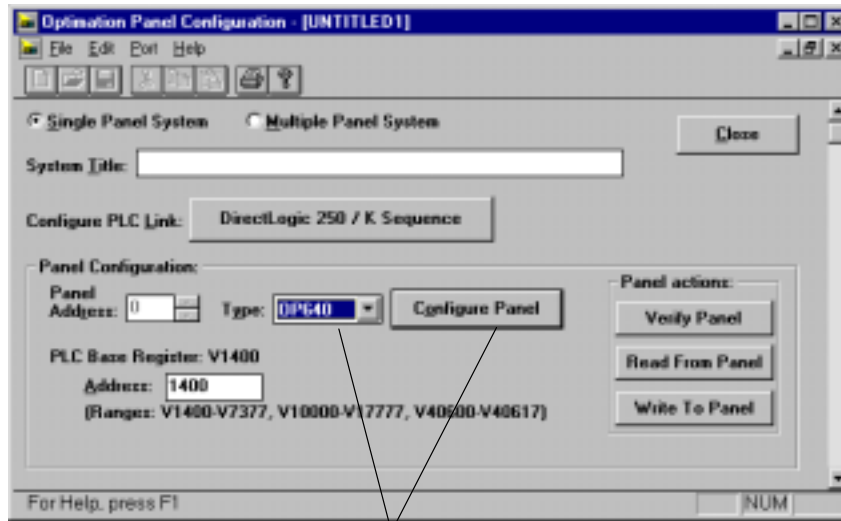

2. Select **OP-640**, and **Configure Panel**.

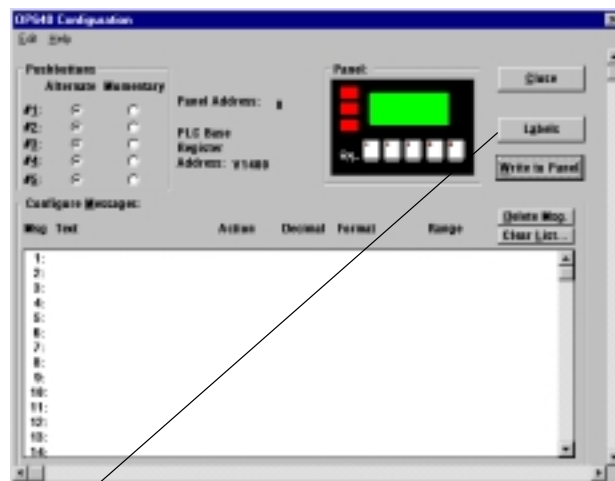

3. Select **Labels**.

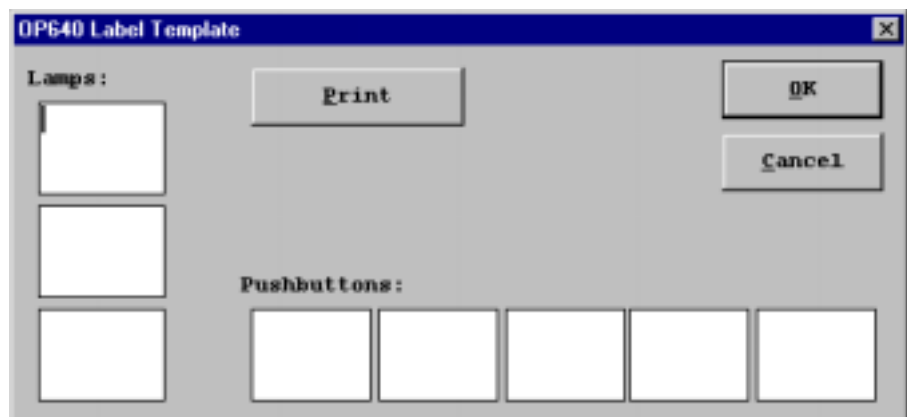

4. The OP-640 Label Template appears. Type in the label text for the five pushbuttons and the three lamps. Press **OK** to save the labels.

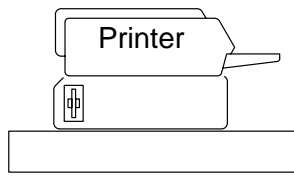

5. **Print** label on transparent film.

6. Cut out the block of labels and insert them in the panel.



Transparent Sheet

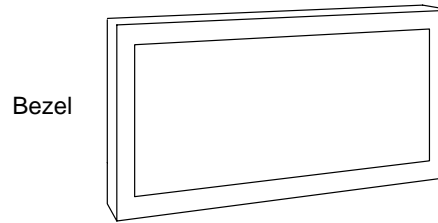
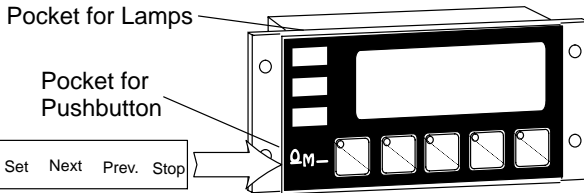
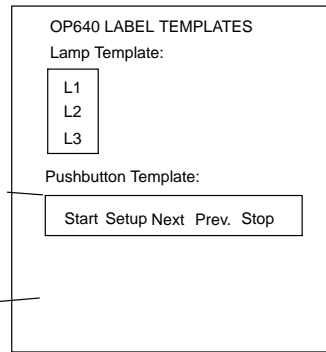

Remove the bezel from the module by unsnapping the four plastic tabs which secure the bezel to the module frame. Locate the pocket, and carefully slide the labels into place. Re-attach the bezel by snapping the bezel onto the case.

Templates for Manually Creating Labels

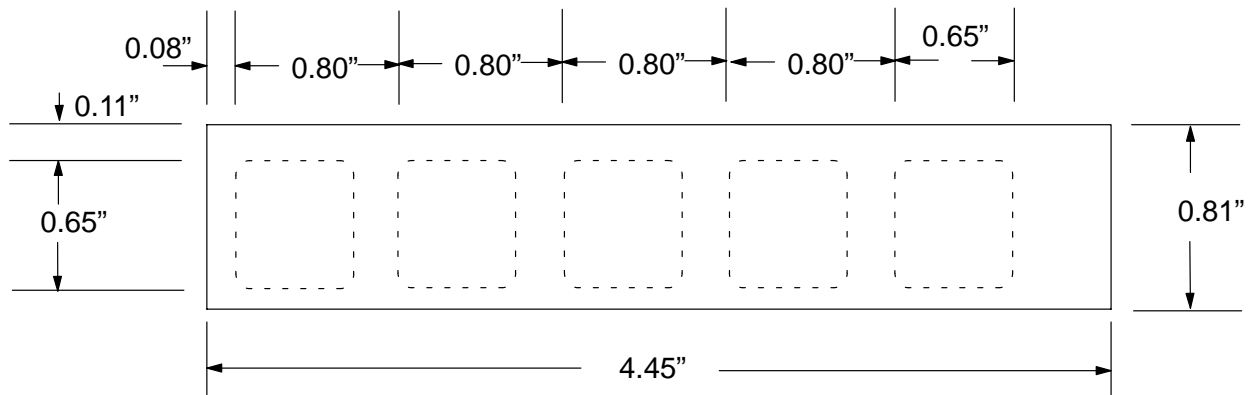

Pushbutton Label Strip Pattern

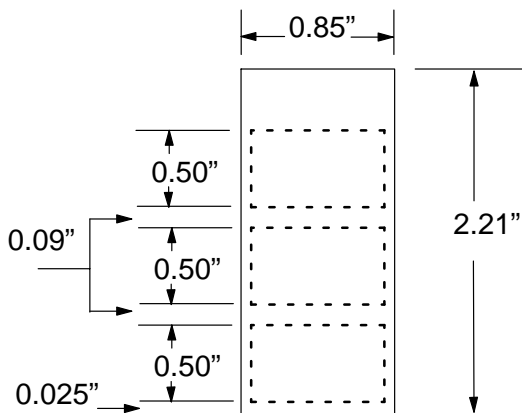

Indicator Lamp Label Strip Pattern

Dimensions for Mounting

Installation and Specifications

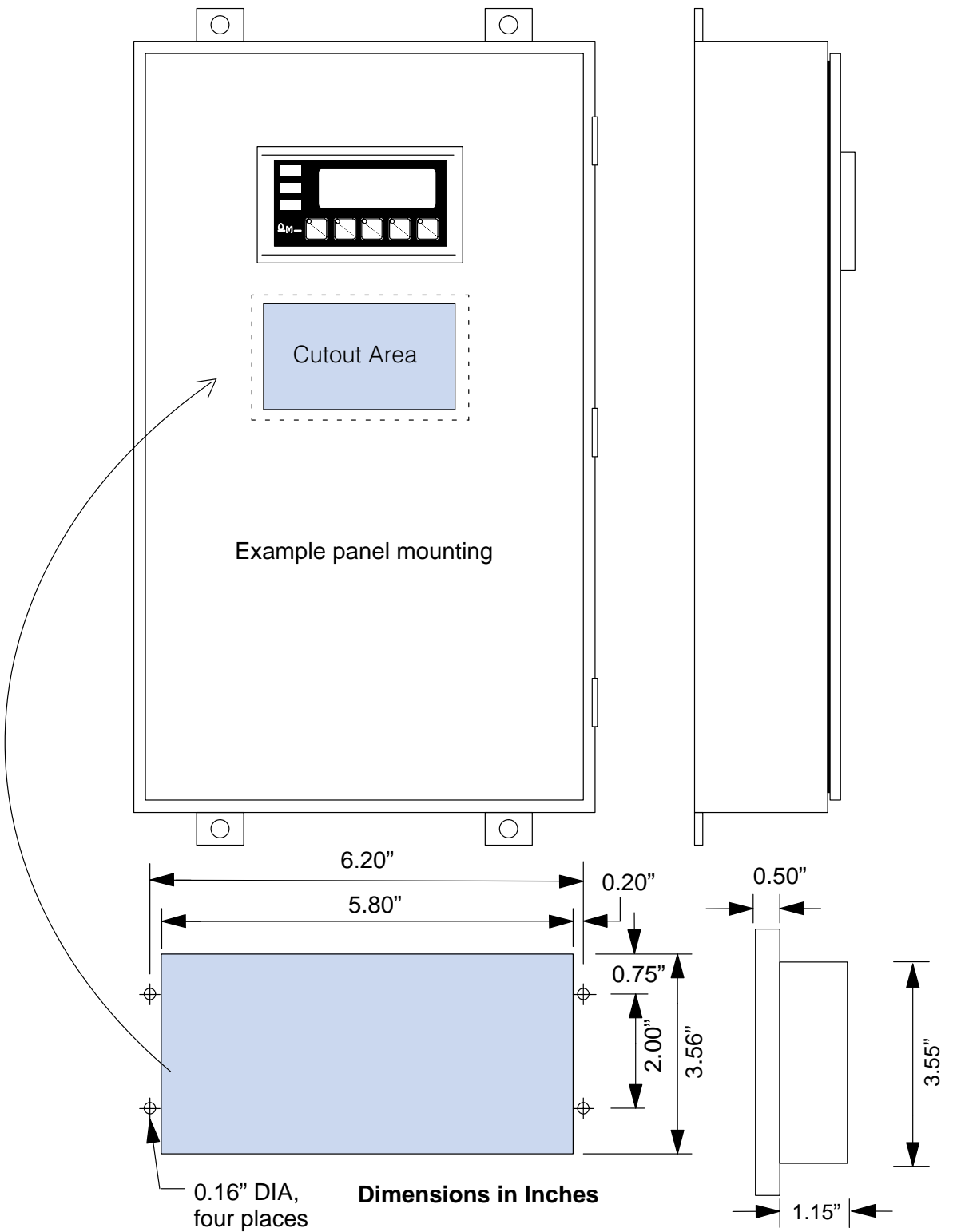

Panel Specifications

Physical

Specifications

Weight	12 ounces
Panel Fasteners	Four 6x32 threaded studs
Pushbutton Life	1,000,000 switch cycles
LCD Display	4 line x 20 character STN with LED backlight; 4.75mm high x 2.95mm wide character size
Lamp Colors	Red, Yellow and Green
NEMA Rating	NEMA 4 (when properly installed)

Environmental Specifications

Operating Temperature	0° to 50° C
Storage Temperature	-20° to 70° C
Operating Humidity	95% (non-condensing)
Air Composition	No corrosive gases permitted

Operating

Specifications

Power Consumption	2.4W @ 8–30VDC (Power On surge of 1.5–2.0A for 1 ms max.)
Power Connector	Keyed terminal block
Diagnostics	LED Status
Communication Link	RS-232 4800 to 19200 baud 15 pin female D shell connector
Message Types (160 max.)	General Text Data display (one value per line)
Numeric Types & Values	Integer Fixed Point BCD (values 0 – 9999, with appropriate decimal placement) BCD Double (values 0 – 99999999, with appropriate decimal placement) Binary (values 0 – 65535, with appropriate decimal placement) Floating Point (values -3.402823E+38 to 3.402823E+38 with appropriate decimal placement)