

# INSTALLATION AND WIRING

---



# CHAPTER 5

## In This Chapter...

Three Levels of Protection .....	5-4
Orderly System Shutdown .....	5-4
System Power Disconnect .....	5-4
Emergency Stop Circuits.....	5-5
<b>Introduction to the Productivity® 1000 Mechanical Design .....</b>	<b>5-6</b>
Typical Productivity1000 System .....	5-6
<b>Dimensions and Installation .....</b>	<b>5-7</b>
<b>Basic Dimensions .....</b>	<b>5-9</b>
<b>Mounting Guidelines .....</b>	<b>5-11</b>
Enclosures.....	5-11
Mounting Position.....	5-11
Using Mounting Rails.....	5-11
Mounting Clearances.....	5-12
Temperature Considerations.....	5-12
Power Considerations .....	5-12
Grounding .....	5-13
Agency Approvals .....	5-13
Installing the Power Supply.....	5-14
DIN Rail Mounting P1000 System .....	5-15
Surface Mounting P1000 System.....	5-15
Installing the I/O Modules.....	5-16
<b>Wiring Guidelines .....</b>	<b>5-17</b>
Power Supply Wiring.....	5-17
Grounding .....	5-17
Fuse Protection.....	5-18
<b>I/O Module Wiring Options.....</b>	<b>5-19</b>

## Table of Contents

---

Hand Wiring System.....	5-19
<b>ZIP</b> Link Wiring System .....	5-20
Terminal Block With Pigtail Cable.....	5-20
Input and Output Modules <b>ZIP</b> Link Selections.....	5-21
Analog Modules <b>ZIP</b> Link Selections .....	5-22
Removable Terminal Blocks (Optional) .....	5-23
P1-10RTB and P1-10RTB-1 .....	5-23
P2-RTB and P2-RTB-1 .....	5-23
Terminal Block Installation .....	5-24
Terminal Block Removal.....	5-25
Planning the I/O Wiring Routes.....	5-25
<b>System Wiring Strategies</b> .....	<b>5-26</b>
CPU Isolation Boundaries.....	5-26
Sinking/Sourcing Concepts .....	5-27
I/O "Common Terminal" Concepts .....	5-28
DC Input Wiring Methods.....	5-29
DC Output Wiring Methods.....	5-29
Relay Outputs - Wiring Methods.....	5-31
Relay Outputs – Transient Suppression for Inductive Loads in a Control System .....	5-32

# Safety Guidelines



**NOTE:** Products with CE marks perform their required functions safely and adhere to relevant standards as specified by CE directives provided they are used according to their intended purpose and that the instructions in this manual are adhered to. The protection provided by the equipment may be impaired if this equipment is used in a manner not specified in this manual. A listing of our international affiliates is available on our Web site at <http://www.automationdirect.com>.



**WARNING:** Providing a safe operating environment for personnel and equipment is your responsibility and should be your primary goal during system planning and installation. Automation systems can fail and may result in situations that can cause serious injury to personnel or damage to equipment. Do not rely on the automation system alone to provide a safe operating environment. You should use external electromechanical devices, such as relays or limit switches, that are independent of the CPU application to provide protection for any part of the system that may cause personal injury or damage. Every automation application is different, so there may be special requirements for your particular application. Make sure you follow all national, state, and local government requirements for the proper installation and use of your equipment.

## Plan for Safety

The best way to provide a safe operating environment is to make personnel and equipment safety part of the planning process. You should examine every aspect of the system to determine which areas are critical to operator or machine safety. If you are not familiar with CPU system installation practices, or your company does not have established installation guidelines, you should obtain additional information from the following sources.

- NEMA — The National Electrical Manufacturers Association, located in Washington, D.C., publishes many different documents that discuss standards for industrial control systems. You can order these publications directly from NEMA. Some of these include:
  - ICS 1, General Standards for Industrial Control and Systems
  - ICS 3, Industrial Systems
  - ICS 6, Enclosures for Industrial Control Systems
- NEC — The National Electrical Code provides regulations concerning the installation and use of various types of electrical equipment. Copies of the NEC Handbook can often be obtained from your local electrical equipment distributor or your local library.
- Local and State Agencies — many local governments and state governments have additional requirements above and beyond those described in the NEC Handbook. Check with your local Electrical Inspector or Fire Marshall office for information.

### Three Levels of Protection



**WARNING:** The control program must not be the only form of protection for any problems that may result in a risk of personal injury or equipment damage.

The publications mentioned provide many ideas and requirements for system safety. At a minimum, you should follow these regulations. Also, you should use the following techniques, which provide three levels of system control.

1. Orderly system shutdown sequence in the CPU control program.
2. Mechanical disconnect for output module power.
3. Emergency stop switch for disconnecting system power.

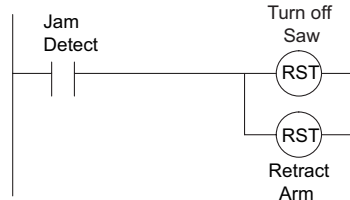
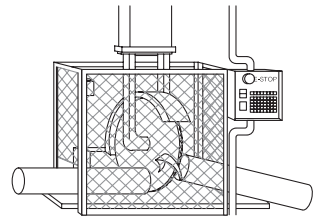

### Orderly System Shutdown

The first level of fault detection is ideally the CPU control program, which can identify machine problems. Certain shutdown sequences should be performed. These types of problems are usually things such as jammed parts, etc., that do not pose a risk of personal injury or equipment damage.

### System Power Disconnect

You should also use electromechanical devices, such as master control relays and/or limit switches, to prevent accidental equipment startup at an unexpected time. These devices should be installed in a manner that will prevent any machine operations from occurring. For example, if the machine in the illustration has a jammed part, the CPU control program can turn off the saw blade and retract the arbor. If the operator must open the guard to remove the part, you should also include a bypass switch that disconnects all system power any time the guard is opened.



# Productivity® 1000 Mechanical Design

The Productivity1000 is a modular system requiring one CPU and up to 15 expansion I/O modules. Expansion modules are connected directly to the right side of the CPU and to each other in a continuous stack. Connect any I/O module combination to the right of the CPU without power budget or module type restrictions\*. No backplane or base is required. Each module connection extends the backbone communication bus. The system can be further expanded using the P1-RX module supporting up to eight expansion I/O modules.

## Typical Productivity1000 System

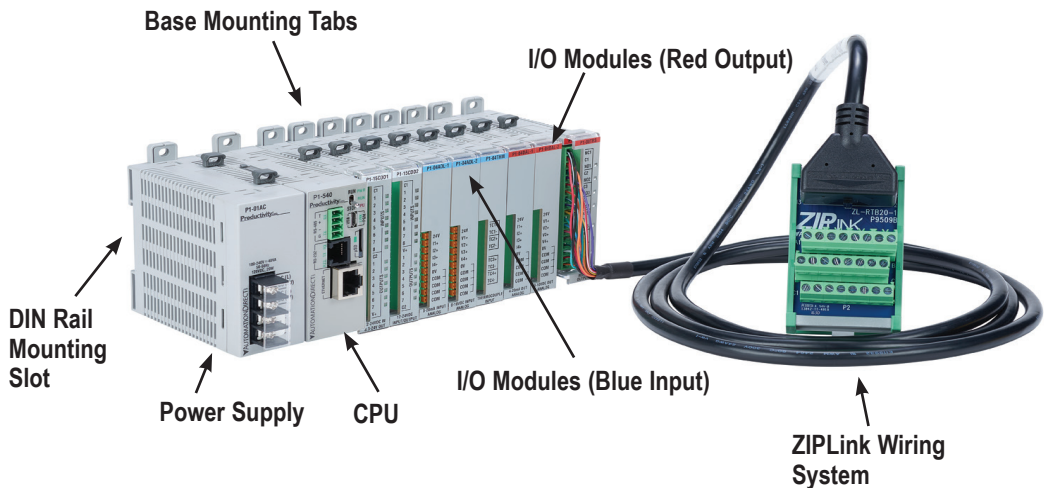

**\*NOTE:** P1-01AC or P1-01DC will power up to 8 modules, and the P1-02AC will power up to 15 modules.

## Dimensions and Installation

Before installing the CPU system you will need to know the dimensions of the components considered. The tables and diagrams on the following pages provide basic dimensions to use in defining your enclosure specifications. Remember to leave room for expansion module insertion and/or replacement and for potential expansion. If you are using other components in your system, refer to the appropriate manual to determine how those units can affect mounting dimensions.

The basic dimensions for the modules are listed in the tables. The width varies depending on the type of module. Productivity1000 is designed to be mounted on standard 35mm DIN rail, or it may be surface mounted. Make sure you have followed the installation guidelines for proper spacing.



**NOTE:** Dimensional drawings for the CPU, power supply and all modules are available on the [AutomationDirect.com](http://AutomationDirect.com) site.

Productivity1000 Component Dimensions						
Module	Description	A	B	C	D	
		Width mm [in]	Height Faceplate mm [in]	Height w/Tabs mm [in]	Depth mm [in]	
P1-540	CPU	32.8 [1.89]	77.4 [3.03]	92.8 [3.65]	91.6 [3.6]	
P1-550				95.4 [3.75]	97.1 [3.82]	
P1-RX	Remote I/O Module	23.1 [0.91]	77 [3.03]	92.8 [3.65]	90.6 [3.57]	
P1-01AC	AC/DC Power Supply	35.0 [1.38]	77.0 [3.03]	92.8 [3.65]	98.3 [3.87]	
P1-02AC	AC Power Supply	52.2 [2.06]				
P1-01DC	DC Power Supply	35.0 [1.38]				
Discrete Expansion Modules						
P1-08SIM	Simulator Input	17.2 [0.68]	77.0 [3.03]	93.6 [3.69]	86.6 [3.41]	
P1-08ND3	Sinking/Sourcing 12–24 VDC Input					
P1-08ND-TTL	Sinking/Sourcing Input					
P1-16ND3	Sinking/Sourcing 12–24 VDC Input				86.6 [3.41]	
P1-08NE3	Sinking/Sourcing 12–24 VDC Input					
P1-16NE3	Sinking/Sourcing 12–24 VDC Input					
P1-08NA	AC Isolated 100–240 VAC					
P1-08TD-TTL	Sourcing Output					81.6 [3.21]
P1-08TD1	Sinking Output					86.6 [3.41]
P1-08TD2	Sourcing Output					
P1-15TD1	Sinking Output					
P1-15TD2	Sourcing Output					

## Dimensions and Installation (cont'd)

Productivity1000 Component Dimensions					
Module	Description	A	B	C	D
		Width mm [in]	Height Faceplate mm [in]	Height w/Tabs mm [in]	Depth mm [in]
P1-08TA	AC Output	17.2 [0.68]	77.0 [3.03]	93.6 [3.69]	86.6 [3.41]
P1-08TRS	Isolated Relay Output	26.3 [1.03]			
P1-16TR	Relay Output				
P1-15CDD1	Input: Sinking/Sourcing; Output: Sinking	17.2 [0.68]	77.0 [3.03]	93.6 [3.69]	86.6 [3.41]
P1-15CDD2	Input: Sinking/Sourcing; Output: Sourcing				
P1-16CDR	Input: Sinking/Sourcing; Output: Relay	26.3 [1.03]			
Analog Expansion Modules					
P1-04RTD	RTD Input	17.2 [0.68]	77.0 [3.03]	93.6 [3.69]	81.6 [3.21]
P1-04THM	Thermocouple Input				
P1-04NTC	Thermistor Input				
P1-04AD	Analog Input (Current/Voltage)				
P1-04AD-1	Analog Input (Current)				
P1-04AD-2	Analog Input (Voltage)	17.2 [0.68]	77.0 [3.03]	93.6 [3.69]	81.9 [3.22]
P1-04ADL-1	Analog Input (Current)				
P1-04ADL-2	Analog Input (Voltage)				
P1-04DAL-1	Analog Output (Current)				
P1-04DAL-2	Analog Output (Voltage)				
P1-08ADL-1	Analog Input (Current)	17.2 [0.68]	77.0 [3.03]	93.6 [3.69]	81.6 [3.21]
P1-08ADL-2	Analog Input (Voltage)				
P1-08DAL-1	Analog Output (Current)				
P1-08DAL-2	Analog Output (Voltage)				
P1-4ADL2DAL-1	Analog Input/Analog Output (Current)				
P1-4ADL2DAL-2	Analog Input/Analog Output (Voltage)				
Specialty Expansion Modules					
P1-02HSC	High-Speed Input (Current)	17.2 [0.68]	77.0 [3.03]	93.6 [3.69]	81.6 [3.21]
P1-04PWM	Pulse Width Modulation Input (Voltage)				





## Basic Dimensions (cont'd)

P1-RX Module

Units: mm [in]

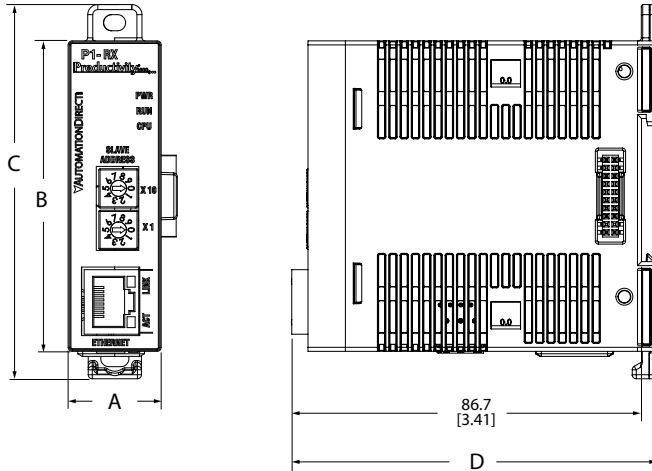

I/O Modules

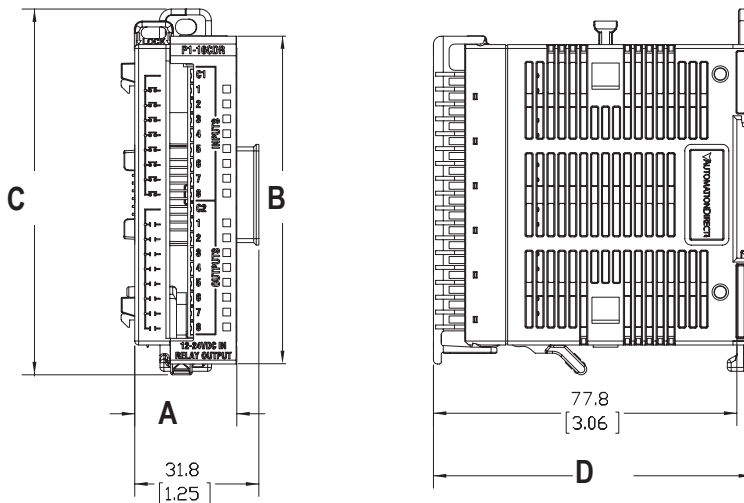

# Mounting Guidelines

## Enclosures

Your selection of a proper enclosure is important to ensure safe and proper operation of your Productivity® 1000 system. Applications for the Productivity1000 system vary and may require additional hardware considerations. The minimum considerations for enclosures include:

- Conformance to electrical standards
- Protection from the elements in an industrial environment
- Common ground reference
- Maintenance of specified ambient temperature
- Access to the equipment
- Security or restricted access
- Sufficient space for proper installation and maintenance of the equipment

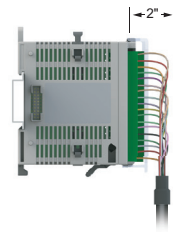

**NOTE:** Add 2" to mounting depth when using ZIPLink cable.

## Mounting Position

Mount the CPU and expansion modules horizontally, as shown in the illustration on the following page, to provide proper ventilation. Do not mount vertically, upside down, or on a flat horizontal surface.

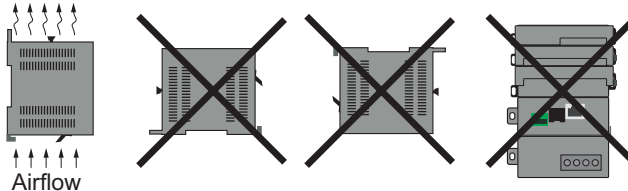

## Using Mounting Rails

The Productivity1000 modules can be secured within an enclosure or cabinet using mounting rails. Use rails that conform to DIN EN standard 50022. We offer a complete line of DIN rail, DINnectors and DIN rail mounted apparatus. The rails are approximately 35mm high with a depth of 7.5 mm. If you mount the module(s) on a DIN rail, consider using end brackets on each side of the base. The end brackets keep the module(s) from sliding horizontally along the rail, thus minimizing the possibility of accidentally pulling the wiring loose.

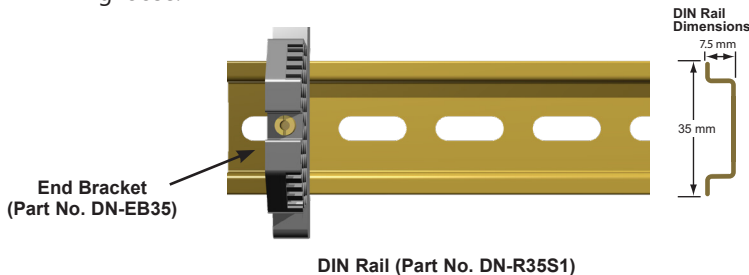

### Mounting Clearances

Provide a minimum clearance of 2 inches (50mm) on all sides of the module(s). Allow extra clearance for door mounted operator panels, push buttons, lights and other items. There should be a minimum of 3 inches (76mm) vertical clearance between the module(s) and any wire duct, and a minimum of 7.2 inches (183mm) vertical distance from chassis to chassis in a multiple unit installation.

### Temperature Considerations

The Productivity® 1000 system enclosure should be installed in an environment which is within the specified equipment operating temperature. If the environment temperature deviates above or below the specification, measures such as cooling or heating the enclosure should be taken to maintain the specification.

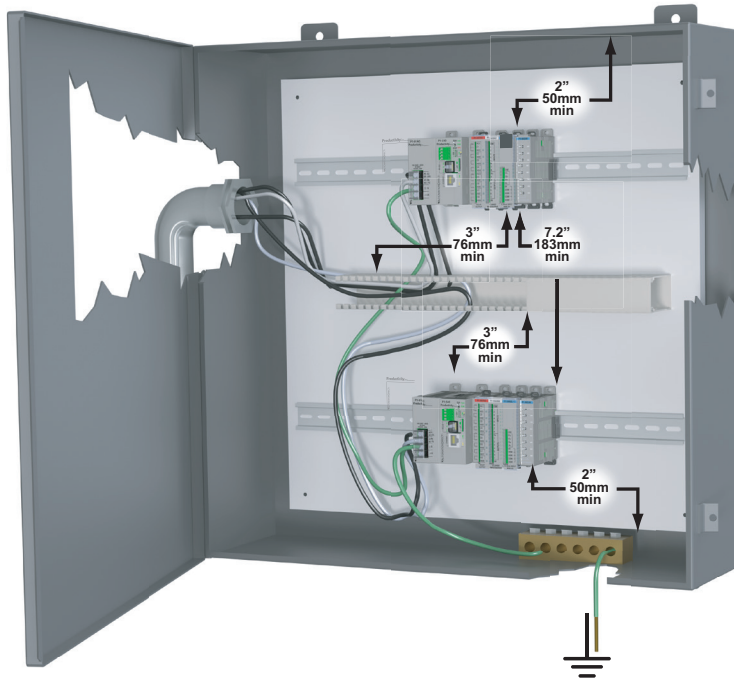

### Power Considerations

The Productivity1000 system is designed to be powered by 110/240 VAC or 125VDC power supply. The Productivity1000 has achieved CE certification without requiring EMF/RFI line noise filters on the AC power supply. Please review the European Union (CE) material in Appendix A for more information.

In addition to the panel layout guidelines, other specifications can affect the installation of a CPU system. Always consider the following:

- Environmental Specifications
- Power Requirements
- Agency Approvals
- Enclosure Selection and Component Dimensions

### Grounding

A sound common ground reference (earth ground) is essential for proper operation of the Productivity® 1000 system. One side of all control circuits and power circuits along with the ground lead must be properly connected to earth ground (earthing) either by installing a ground rod in close proximity to the enclosure or by connecting to the incoming power system ground. There must be a single-point ground (i.e. copper bus bar) for all devices in the enclosure that require an earth ground.

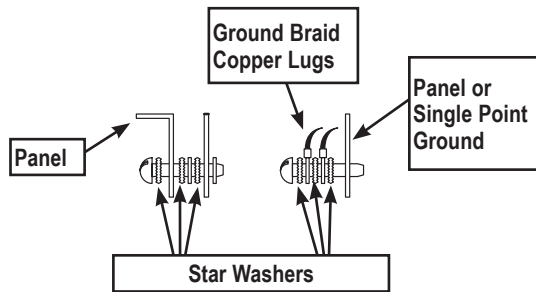

**WARNING:** Do not disconnect equipment unless power has been switched off or the area is known to be a non-hazardous environment.

### Agency Approvals

Some applications require agency approvals for particular components. The Productivity1000 CPU agency approvals are listed below:

- UL (Underwriters' Laboratories, Inc.)
- CUL (Canadian Underwriters' Laboratories, Inc.)
- CE (European Economic Union)



**NOTE:** See the "EU Directives(CE)" in Appendix A in this manual for more information.

## Installing the Power Supply



**NOTE:** Removable DC power connector must be removed prior to performing this step.

### Step One:

With latch in “locked” position, align connectors on the side of each module and stack by pressing together. An audible click indicates lock is engaged.

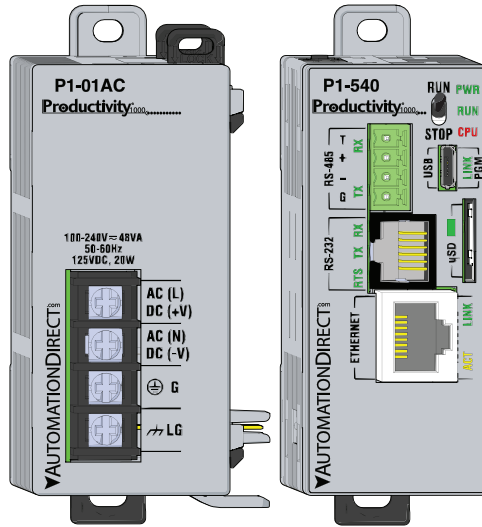
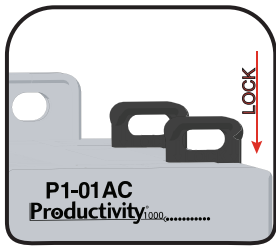

### Step Two:

To unstack modules, pull locking latch up into the unlocked position and then pull modules apart.

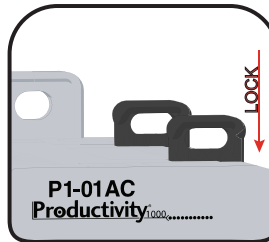
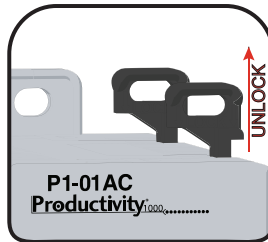

**WARNING:** Explosion hazard – Do not connect, disconnect or operate switches while circuit is live unless the area is known to be non-hazardous. Do not hot swap.

### DIN Rail Mounting P1000 System

If you examine the module(s), you'll notice retaining clips. To secure the module(s) to a DIN rail, place the module(s) onto the rail and gently push up on the retaining clips. The spring loaded clips lock the module onto the rail. To remove the module(s), pull down on the retaining clips, slightly lift up the base, and pull it away from the rail.

This installation procedure applies to the P1-540 or P1-550 CPU module with power supply.

**Step 1:** Rotate unit upwards as you engage rear DIN rail slot (image at right). Once engaged, rotate unit downwards, firmly pressing into DIN rail. A noticeable click affirms the unit is secure to DIN rail.

**Step 2:** Ensure all retaining clips are pushed up into DIN rail.

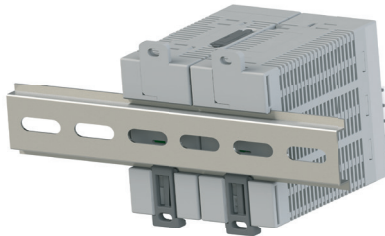
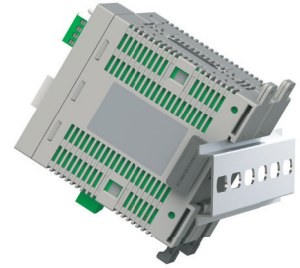

Push up retaining clips

Install end brackets on either side of unit to ensure unit will not slide along the DIN rail.

### Surface Mounting P1000 System

The P1000 system may be surface mounted as well. Extend the lower tabs for ease of access. Use mounting holes in top and bottom tabs to secure the unit to panel surface.



Extend lower tabs to install hardware for surface mount installation.

## Installing the I/O Modules

### Step One:

With latch in “locked” position, align connectors on the side of each module and stack by pressing together. An audible click indicates lock is engaged.

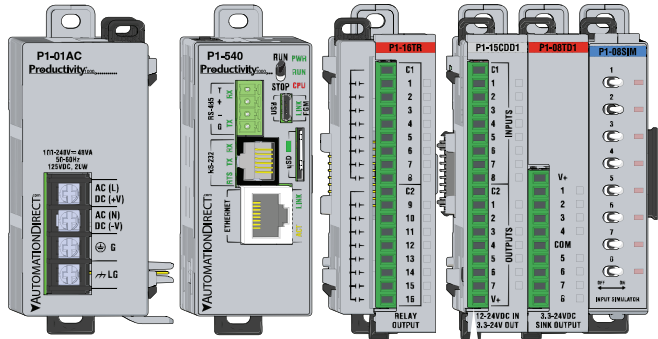
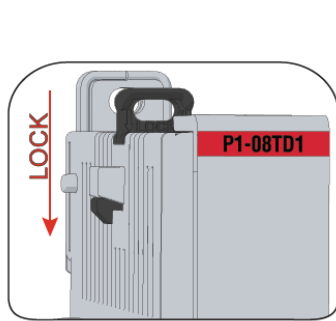

### Step Two:

To unstack modules, pull locking latch up into the unlocked position and then pull modules apart.



**WARNING:** Explosion hazard – Do not connect, disconnect modules or operate switches while circuit is live. Productivity® 1000 System does not support Hot Swapping!





## Wiring Guidelines

### Power Supply Wiring

Connect the AC power source input wiring to the power supply as shown. The power supply terminals can accept up to 14AWG solid or stranded wire. Do not over tighten the terminal screws; the recommended torque is 7 to 9 inch-pounds (0.882 to 1.02 N-m).

#### P1-01AC and P1-02AC

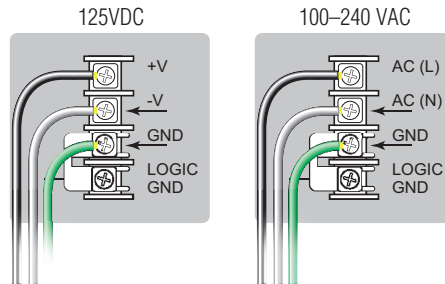

#### P1-01DC

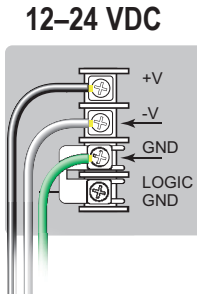

**WARNING:** Once the power wiring is connected, secure the terminal block cover in the closed position. When the cover is open there is a risk of electrical shock if you accidentally touch the connection terminals or power wiring.

### Grounding

A good common ground reference (earth ground) is essential for proper operation of the Productivity® 1000 system. One side of all control circuits and power circuits along with the ground lead must be properly connected to earth ground by either installing a ground rod in close proximity to the enclosure or by connecting to the incoming power system ground. There must be a single-point ground (i.e. copper bus bar) for all devices in the enclosure that require an earth ground.

### Fuse Protection

Some of the Input and Output I/O module circuits do not have internal fuses. In order to protect your modules, we suggest you add external fuses to your I/O wiring. A fast-blow fuse with a lower current rating than the I/O bank's common current rating can be wired to each common; or a fuse with a rating of slightly less than the maximum current per output point can be added to each output. Refer to the I/O module specifications in Chapter 2 to find the maximum current per output point or per output common. Adding the external fuse does not guarantee the prevention of CPU damage, but it will provide added protection.

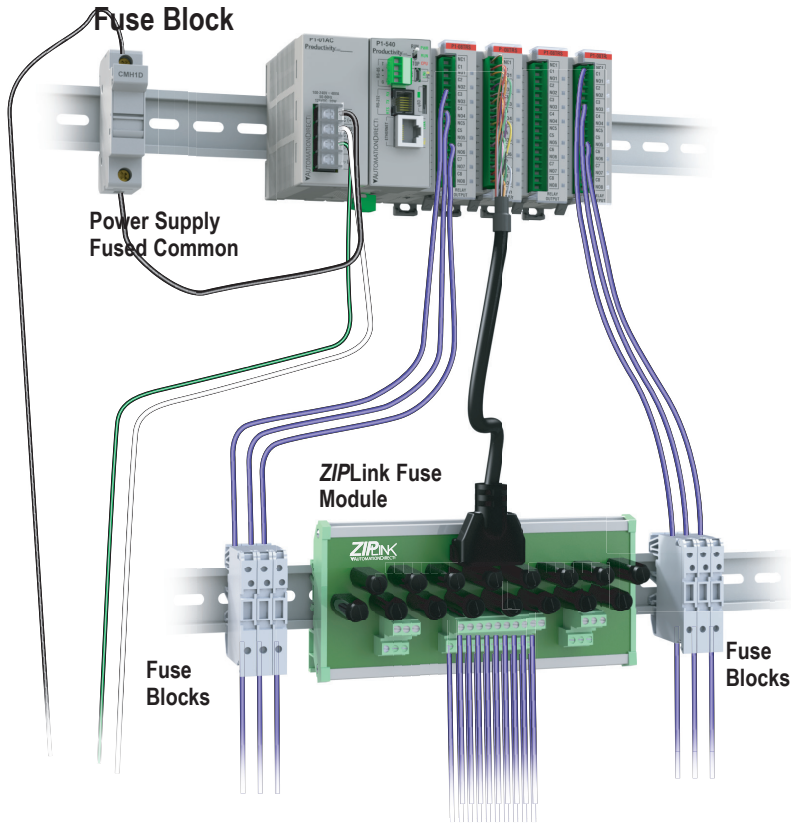

## I/O Module Wiring Options

There are two available methods for wiring most I/O modules: hand wiring to the optional removable I/O module terminal blocks or using the ZIPLink wiring system.



**NOTE:** Thermocouple and Thermistor modules are not compatible with the ZIPLink system and are shipped with fixed terminal blocks included.

### Hand Wiring System

Field wiring may be attached using the removable terminal block connector. Use Wire Strip Length reference on the terminal block as a guide when preparing wire for termination. For easier assembly, wire may be connected to terminal block prior to installing block into expansion module.

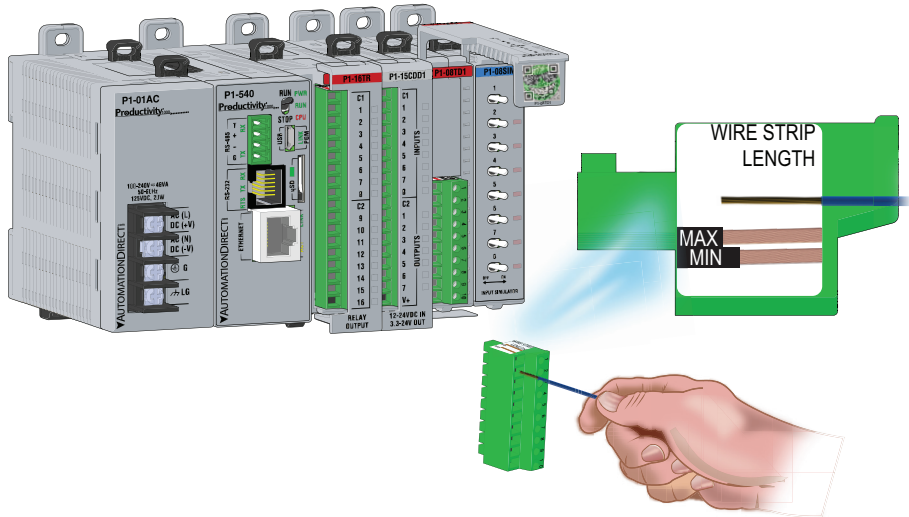

## I/O Module Wiring Options (cont'd)

### ZIPLink Wiring System

The ZIPLink wiring system is the recommended method, which allows quick and easy connection using cables that are prewired to the I/O module terminals at one end and plug into a ZIPLink connector module terminal block at the other end. Use the tables on the following pages to specify your ZIPLink wiring system.

ZIPLink Wiring System

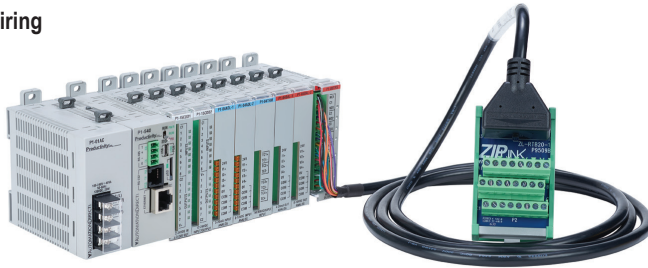

ZIPLink Pre-Wired Cables



ZIPLink Module

### Terminal Block With Pigtail Cable

For most I/O modules you can also purchase ZIPLink pigtail cables.

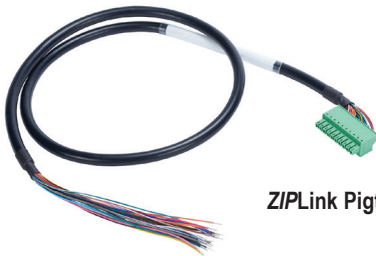

ZIPLink Pigtail Cable

Input and Output Modules ZIPLink Selections

Productivity1000 Input Module ZIPLink Selector				
I/O Module		ZIPLink		
Input Module	# of Terms	Component	Module Part No.	Cable Part No.
P1-08ND-TTL	10	Feedthrough	ZL-RTB20 or ZL-RTB20-1	ZL-P1-CBL10*
P1-08ND3	10			ZL-P1-CBL18*
P1-16ND3	18			ZL-P1-CBL10*
P1-08NE3	10			ZL-P1-CBL18*
P1-16NE3	18			ZL-P1-CBL10*
P1-08NA	10			ZL-P1-CBL18*

Productivity1000 Output Module ZIPLink Selector					
I/O Module		ZIPLink			
Output Module	# of Terms	Component	Module Part No.	Cable Part No.	
P1-08TD-TTL	10	Feedthrough	ZL-RTB20 or ZL-RTB20-1	ZL-P1-CBL10*	
P1-08TD1	10				ZL-P1-CBL18*
P1-08TD2					
P1-15TD1	18			ZL-P1-CBL18*	
P1-15TD2	18			ZL-P1-CBL10*	
P1-08TA	10			ZL-P1-CBL10*	
P1-08TRS	10			ZL-P1-CBL18*	
P1-16TR	18			ZL-P1-CBL18*	

Productivity1000 Combo Modules ZIPLink Selector				
I/O Module		ZIPLink		
Output Module	# of Terms	Component	Module Part No.	Cable Part No.
P1-15CDD1	18	Feedthrough	ZL-RTB20 or ZL-RTB20-1	ZL-P1-CBL18*
P1-15CDD2				
P1-16CDR				

\* Select the cable length by replacing the \* with: Blank = 0.5 m, -1 = 1.0 m, or -2 = 2.0 m.

## Analog Modules ZIPLink Selections

Productivity1000 Analog Module ZIPLink Selector					
Module		ZIPLink			
Analog Module	# of Terms	Component	Module	Cable	
P1-04AD	18	Feedthrough	ZL-RTB20 or ZL-RTB20-1	ZL-P1-CBL18*	
P1-04AD-1	10	Feedthrough		ZL-RTB20 or ZL-RTB20-1	ZL-P1-CBL10*
P1-04AD-2					
P1-04ADL-1					
P1-04ADL-2					
P1-08ADL-1					
P1-08ADL-2					
P1-04RTD	Matched Only	See Note 1			
P1-04THM	T/C Wire Only	See Note 1			
P1-04NTC	Copper Conductors	See Note 1			
P1-04DAL-1	10	Feedthrough	ZL-RTB20 or ZL-RTB20-1	ZL-P1-CBL10*	
P1-04DAL-2					
P1-08DAL-1					
P1-08DAL-2					

Productivity1000 Analog Combo Module ZIPLink Selector				
Module		ZIPLink		
Analog Module	# of Terms	Component	Module	Cable
P1-4DAL2ADL-1	10	Feedthrough	ZL-RTB20 or ZL-RTB20-1	ZL-P1-CBL10*
P1-4DAL2ADL-2				

Productivity1000 Specialty Modules ZIPLink Selector				
Module		ZIPLink		
Input Module	# of Terms	Component	Module	Cable
P1-08SIM	See Note 1			
P1-02HSC	See Note 1			
P1-04PWM	10	Feedthrough	ZL-RTB20 or ZL-RTB20-1	ZL-P1-CBL10*

\* Select the cable length by replacing the \* with: Blank = 0.5 m, -1 = 1.0 m, or -2 = 2.0 m.  
 1. These modules are not supported by the ZIPLink wiring system.

## Removable Terminal Blocks (Optional)

The hand wiring method consists of purchasing the associated removable I/O module terminal block (table below) and hand wiring from the I/O terminal block to a DIN rail mounted terminal block.

### P1-10RTB and P1-10RTB-1

Removable Terminal Block Specifications		
Part Number	P1-10RTB	P1-10RTB-1
Number of Positions	10 Screw Terminals	10 Spring Clamp Terminals
Wire Range	30–16 AWG (0.051–1.31 mm <sup>2</sup> ) Solid / Stranded Conductor 3/64 in. (1.2 mm) Insulation Max. 1/4 in. (6–7 mm) Strip Length	28–16 AWG (0.081–1.31 mm <sup>2</sup> ) Solid / Stranded Conductor 3/64 in. (1.2 mm) Insulation Max. 19/64 in. (7–8 mm) Strip Length
Conductors	"USE COPPER CONDUCTORS, 75°C" or Equivalent.	
Screw Driver	0.1 inch (2.5 mm) Maximum*	
Screw Size	M2	N/A
Screw Torque	2.5 lb-in (0.28 N-m)	N/A

\* Recommended screw driver: P/N TW-SD-MSL-1.

### P2-RTB and P2-RTB-1

Removable Terminal Block Specifications		
Part Number	P2-RTB	P2-RTB-1
Number of Positions	18 Screw Terminals	18 Spring Clamp Terminals
Wire Range	30–16 AWG (0.051–1.31 mm <sup>2</sup> ) Solid / Stranded Conductor 3/64 in. (1.2 mm) Insulation Max. 1/4 in. (6–7 mm) Strip Length	28–16 AWG (0.081–1.31 mm <sup>2</sup> ) Solid / Stranded Conductor 3/64 in. (1.2 mm) Insulation Max. 19/64 in. (7–8 mm) Strip Length
Conductors	"USE COPPER CONDUCTORS, 75°C" or Equivalent.	
Screw Driver	0.1 inch (2.5 mm) Maximum*	
Screw Size	M2	N/A
Screw Torque	2.5 lb-in (0.28 N-m)	N/A

\* Recommended screw driver: P/N TW-SD-MSL-1.

### Removable Terminal Blocks, continued

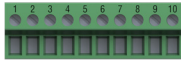

**P1-10RTB (screw terminals)  
Removable Terminal Block**

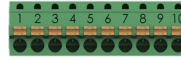

**P1-10RTB-1 (spring-clip terminals)  
Removable Terminal Block**

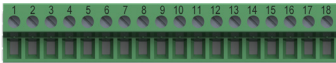

**P2-RTB (screw terminals)  
Removable Terminal Block**

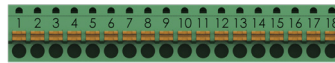

**P2-RTB-1 (spring-clip terminals)  
Removable Terminal Block**

### Terminal Block Installation

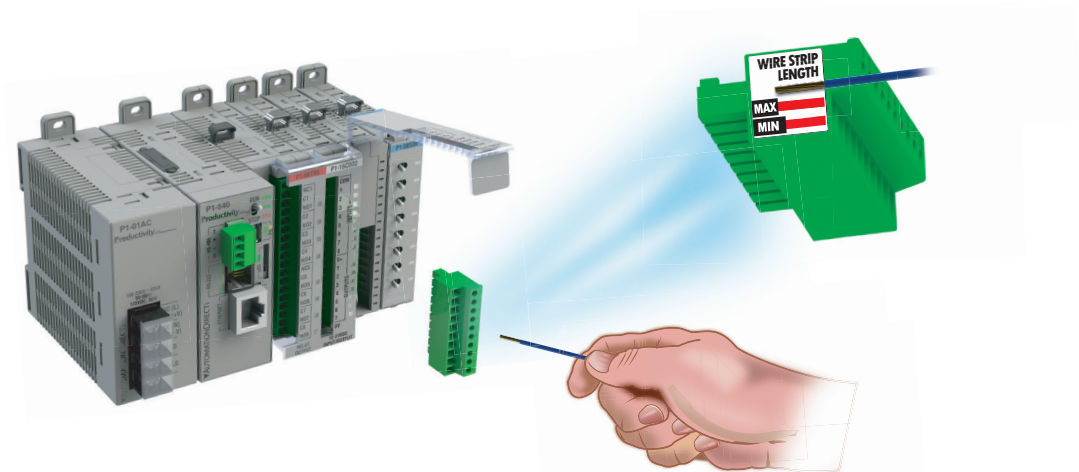

Reference the Wire Strip Length gauge printed on the end of the terminal strip as a guide to properly strip wire insulation prior to inserting into terminal block. For ease of assembly, block maybe wired prior to installation, if desired.

Insert terminal block as follows:

- Step 1: Raise finger-safe terminal guard.
- Step 2: Align terminal block with module terminal pins, ensuring correct orientation of block.
- Step 3: Firmly and evenly press terminal block onto terminal pins until seated. Lower finger-safe guard into place.



### Terminal Block Removal



**WARNING:** Ensure local and remote power supplies have been disconnected prior to removing terminal block.

Remove terminal block as follows:

- Step 1: Raise terminal cover.
- Step 2: Pull terminal block release lever forward. This will lift terminal block away from pins.
- Step 2: Grasp block firmly and pull away from module.

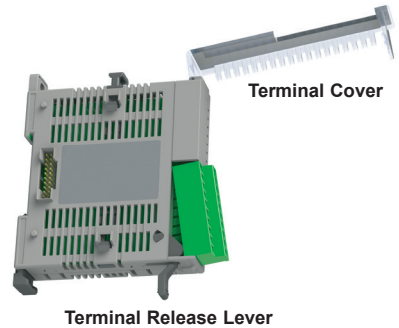

### Planning the I/O Wiring Routes

The following guidelines provide general information on how to wire the I/O connections to Productivity® 1000 modules. For specific information on wiring a particular I/O module refer to the module specifications in Chapter 2.

1. If using removable terminal blocks, follow the wire size guidelines in the I/O modules specifications in Chapter 2.
2. Always use a continuous length of wire. Do not splice wires to create a needed length.
3. Use the shortest possible wire length.
4. Use wire trays for routing where possible.
5. Avoid running low voltage control wires near high voltage wiring.
6. Avoid confusion by laying input wiring separate from output wiring where possible.
7. To minimize voltage drops when wires must run a long distance, consider using multiple wires for the return line.
8. Avoid running DC wiring in close proximity to AC wiring where possible.
9. Avoid creating sharp bends in the wires; follow accepted Electrical Code standards.

# System Wiring Strategies

The Productivity® 1000 system is very flexible and will work in many different wiring configurations. By studying this section before actual installation, you may find the best wiring strategy for your application. This will help to lower system cost and wiring errors, and avoid safety problems.

## CPU Isolation Boundaries

CPU circuitry is divided into three main regions separated by isolation boundaries, shown in the drawing below. Electrical isolation provides safety, so that a fault in one area does not damage another. The transformer in the power supply provides magnetic isolation between the primary and secondary sides. Optical isolators provide isolation in Input and Output circuits. This isolates logic circuitry from the field side, where factory machinery connects. The discrete inputs are isolated from the discrete outputs because each is isolated from the logic side. Isolation boundaries protect the devices which are connected to the communication ports, such as PCs and HMIs, from power input faults or field wiring faults. When wiring a CPU, it is extremely important to avoid making external connections that connect logic side circuits to any other.

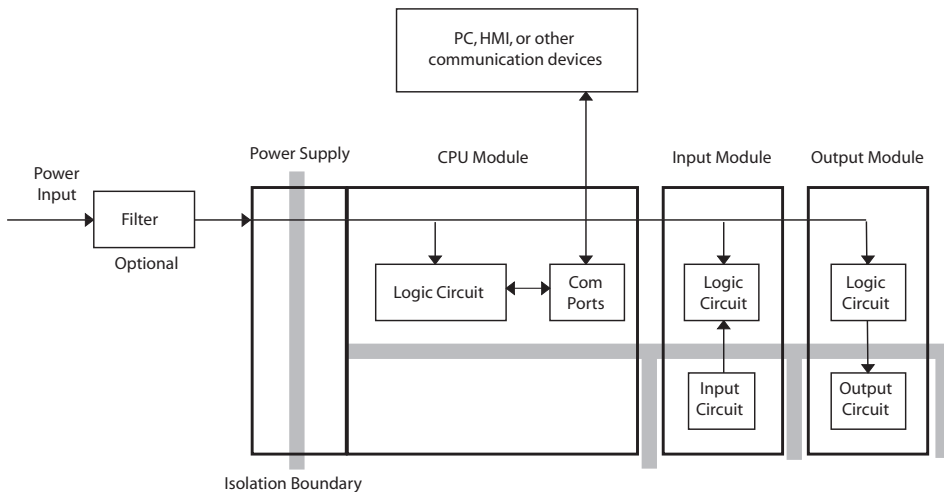

## Sinking/Sourcing Concepts

Before wiring field devices to the CPU I/O, it's necessary to have a basic understanding of "sinking" and "sourcing" concepts. Use of these terms occurs frequently in input or output circuit discussions. These terms only apply to DC circuits, not AC circuits. The purpose of this section is to explain the terms. The short definitions are as follows:

- Sinking = Path to supply ground (-) or switching ground.
- Sourcing = Path to supply source (+) or switching +V.

Input and output points that are either sinking or sourcing can conduct current in only one direction. This means it is possible to wire the external supply and field device to the I/O point with current trying to flow in the wrong direction, in which case the circuit will not operate.

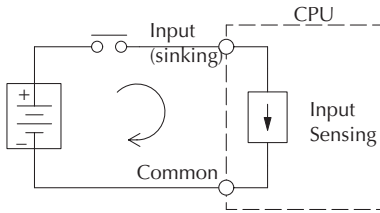

The diagram on the left shows a "sinking" CPU input. To properly connect the external supply, connect it so that the input provides a path to ground (-). Start at the CPU input terminal, follow through the input sensing circuit, exit at the common terminal, and connect the supply (-) to the common terminal.

The switch between the supply (+) and the input completes the circuit. Current flows in the direction of the arrow when the switch is closed. By applying the circuit principle above to the four possible combinations of input/output sinking/sourcing types, we have the four circuits as shown below.

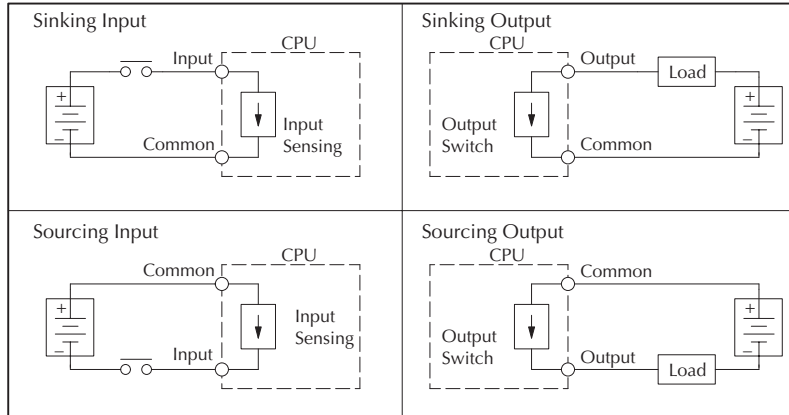

### I/O “Common Terminal” Concepts

In order for a CPU I/O circuit to operate, current must enter at one terminal and exit at another. This means at least two terminals are associated with every I/O point. In the figure below, the input or output terminal is the main path for the current. One additional terminal must provide the return path to the power supply.

If there was unlimited module space then every I/O point could have two dedicated terminals as the figure above shows. Providing this level of flexibility is not practical or necessary for most applications. Most I/O point groups share the return path (common) among two or more I/O points. The figure below shows a group (or bank) of four input points which share a common return path. In this way, the four inputs require only five terminals instead of eight.

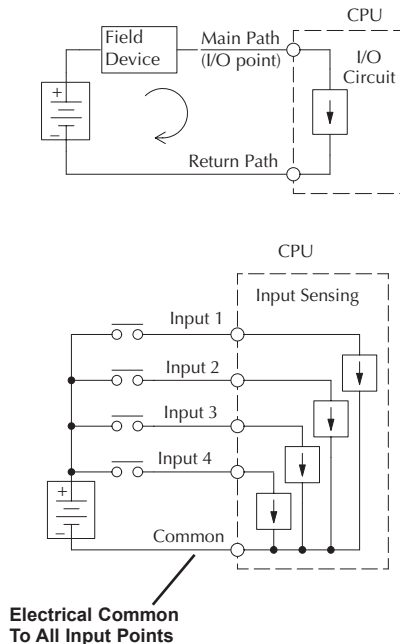

**NOTE:** In the circuit above, the current in the common path is equal to the sum of the energized channels. This is especially important in output circuits, where larger gauge wire is sometimes needed for the commons.

## DC Input Wiring Methods

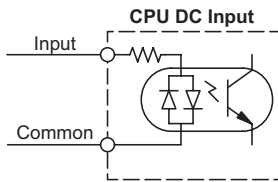

I/O modules with DC inputs can be wired as either sinking or sourcing inputs. The dual diodes (shown in this diagram) allow current to flow in either direction. Inputs grouped by a common point must be either all sinking or all sourcing. DC inputs typically operate in the range of +12–24 VDC.

### Sinking Input Sensor (NPN Type) to CPU Sourcing Input

In the following example, a field device has an open-collector NPN transistor output. When energized, it sinks current to ground from the DC input point. The CPU input current is sourced from the common terminal connected to power supply (+).

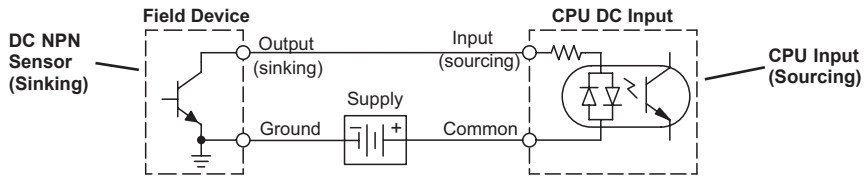

### Sourcing Input Sensor (PNP Type) to CPU Sinking Input

In the following example, a field device has an open-emitter PNP transistor output. When energized, it sources current to the CPU input point, which sinks the current to ground. Since the field device loop is sourcing current, no additional power supply is required for the module.

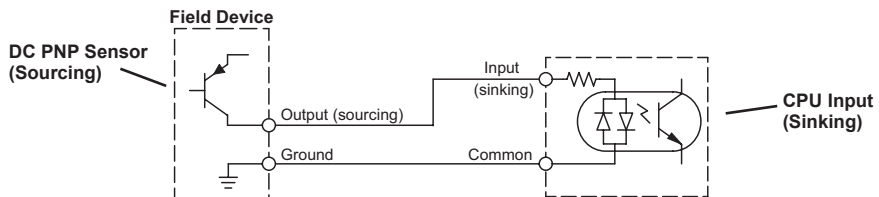

## DC Output Wiring Methods

I/O modules with DC output circuits are wired as all current sinking only or current sourcing only depending on which output module part number is used. DC outputs typically operate in the range of +5–24 VDC.

### CPU Sinking Output to Sourcing Load Device

Many applications require connecting a CPU output point to a DC input on a field device load. This type of connection is made to carry a low-level DC signals.

In the following example, the CPU output point sinks current to ground (common) when energized. The output is connected to a field device load with a sourcing input.

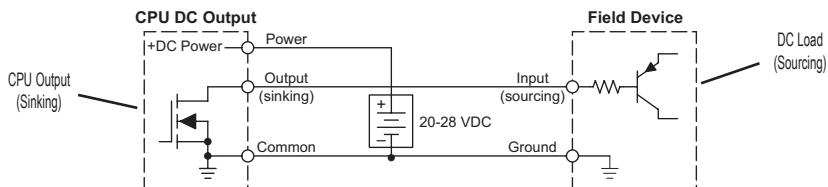

### CPU DC Sinking Output to Sinking Load Device

In the example below, a sinking output point is connected to the sinking input of a field device load. In this case, both the CPU output and field device input are sinking type. Since the circuit must have one sourcing and one sinking device, we add sourcing capability to the CPU output by using a pull-up resistor. In the circuit below, we connect R pull-up from the output to the DC output circuit power input.

**NOTE: DO NOT attempt to drive a heavy load (>25mA) with this pull-up method.**

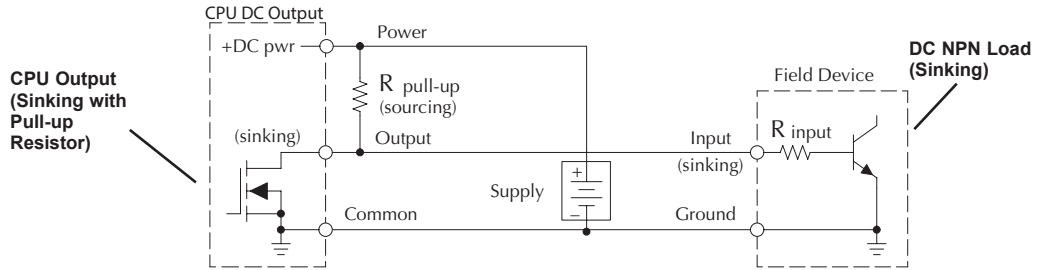

**NOTE:** Using the pull-up resistor to implement a sourcing output has the effect of inverting the output point logic. In other words, the field device input is energized when the CPU output is OFF, from a ladder logic point-of-view. Your ladder program must comprehend this and generate an inverted output. Or, you may choose to cancel the effect of the inversion elsewhere, such as in the field device.

It is important to choose the correct value of R<sub>pull-up</sub>. In order to do so, we need to know the nominal input current to the field device (I<sub>input</sub>) when the input is energized. If this value is not known, it can be calculated as shown (a typical value is 15mA). Then use I<sub>input</sub> and the voltage of the external supply to compute R<sub>pull-up</sub>. Then calculate the power P<sub>pull-up</sub> (in watts), in order to size R<sub>pull-up</sub> properly.

$$I_{\text{input}} = \frac{V_{\text{input (turn-on)}}}{R_{\text{input}}}$$

$$R_{\text{pull-up}} = \frac{V_{\text{supply}} - 0.7}{I_{\text{input}}} - R_{\text{input}}$$

$$P_{\text{pull-up}} = \frac{V_{\text{supply}}^2}{R_{\text{pull-up}}}$$

### Relay Outputs - Wiring Methods

Relay outputs are available for the Productivity® 1000. Relays are best for the following applications:

- Loads that require higher currents than the solid-state outputs can deliver
- Cost-sensitive applications
- Some output channels need isolation from other outputs (such as when some loads require different voltages than other loads)

Some applications in which NOT to use relays:

- Loads that require currents under 10mA
- Loads which must be switched at high speed or heavy duty cycle.

#### Relay with Form A contacts

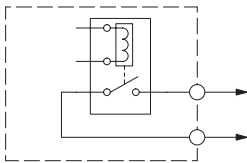

Relay outputs are available in two contact arrangements. Form A type, or SPST (single pole, single throw) type. They are normally open and are the simplest to use. The Form C, or SPDT (single pole, double throw) type has a center contact which moves and a stationary contact on either side. This provides a normally closed contact and a normally open contact.

#### Relay with Form C contacts

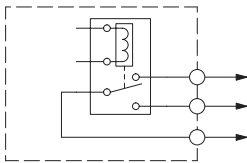

The relays in some relay output modules share common terminals, which connect to the wiper contact in each relay of the bank. Other relay modules have relays which are completely isolated from each other. In all cases, the module drives the relay coil when the corresponding output point is on.

### Relay Outputs – Transient Suppression for Inductive Loads

The following pages are intended to give a quick overview of the negative effects of transient voltages on a control system and provide some simple advice on how to effectively minimize them. The need for transient suppression is often not apparent to the newcomers in the automation world. Many mysterious errors that can afflict an installation can be traced back to a lack of transient suppression.

#### What is a Transient Voltage and Why is it Bad?

Inductive loads (devices with a coil) generate transient voltages as they transition from being energized to being de-energized. If not suppressed, the transient can be many times greater than the voltage applied to the coil. These transient voltages can damage CPU outputs or other electronic devices connected to the circuit, and cause unreliable operation of other electronics in the general area. Transients must be managed with suppressors for long component life and reliable operation of the control system.

This example shows a simple circuit with a small 24V/125mA/3W relay. As you can see, when the switch is opened, thereby de-energizing the coil, the transient voltage generated across the switch contacts peaks at 140V.

#### Example Circuit with no Suppression

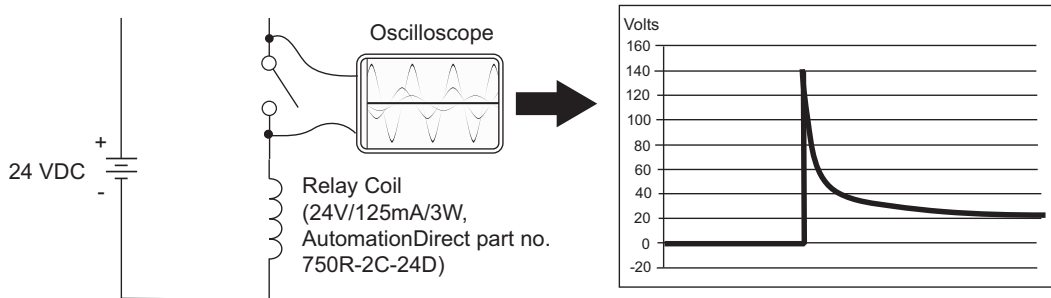

In the same circuit, replacing the relay with a larger 24V/290mA/7W relay will generate a transient voltage exceeding 800V (not shown). Transient voltages like this can cause many problems, including:

- Relay contacts driving the coil may experience arcing, which can pit the contacts and reduce the relay's lifespan.
- Solid state (transistor) outputs driving the coil can be damaged if the transient voltage exceeds the transistor's ratings. In extreme cases, complete failure of the output can occur the very first time a coil is de-energized.
- Input circuits, which might be connected to monitor the coil or the output driver, can also be damaged by the transient voltage.

A very destructive side-effect of the arcing across relay contacts is the electromagnetic interference (EMI) it can cause. This occurs because the arcing causes a current surge, which releases RF energy. The entire length of wire between the relay contacts, the coil, and the power source carries the current surge and becomes an antenna that radiates the RF energy. It will readily couple into parallel wiring and may disrupt the CPU and other electronics in the area. This EMI can make an otherwise stable control system behave unpredictably at times.



## CPU's Integrated Transient Suppressors

Although the CPU outputs typically have integrated suppressors to protect against transients, they are not capable of handling them all. It is usually necessary to have some additional transient suppression for an inductive load.

Here is another example using the same 24V/125mA/3W relay used earlier. This example measures the PNP transistor output of a typical CPU, which incorporates an integrated Zener diode for transient suppression. Instead of the 140V peak in the first example, the transient voltage here is limited to about 40V by the Zener diode. While the CPU will probably tolerate repeated transients in this range for some time, the 40V is still beyond the module's peak output voltage rating of 30V.

### Example: Small Inductive Load with Only Integrated Suppression

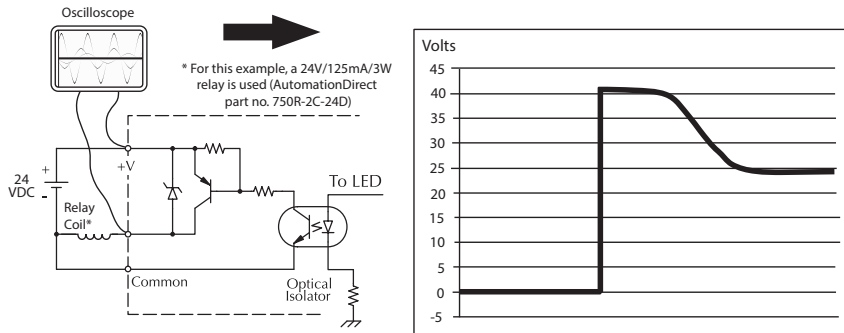

The next example uses the same circuit as above, but with a larger 24V/290mA/7W relay, thereby creating a larger inductive load. As you can see, the transient voltage generated is much worse, peaking at over 50V. Driving an inductive load of this size without additional transient suppression is very likely to permanently damage the CPU output.

### Example: Larger Inductive Load with Only Integrated Suppression

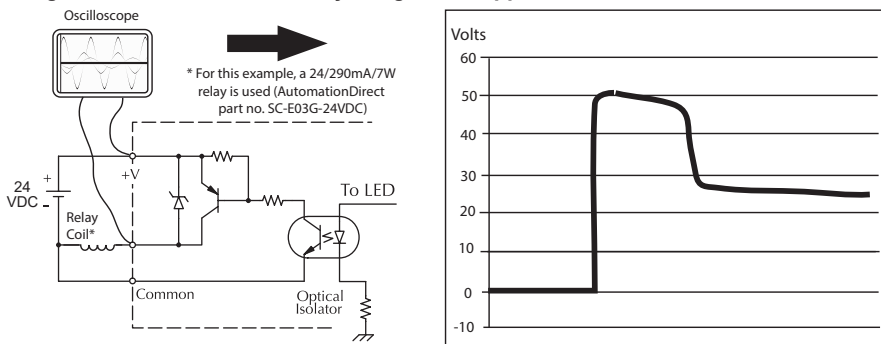

Additional transient suppression should be used in both of these examples. If you are unable to measure the transients generated by the connected loads of your control system, using additional transient suppression on all inductive loads would be the safest practice.

### Types of Additional Transient Protection

#### DC Coils:

The most effective protection against transients from a DC coil is a flyback diode. A flyback diode can reduce the transient to roughly 1V over the supply voltage, as shown in this example.

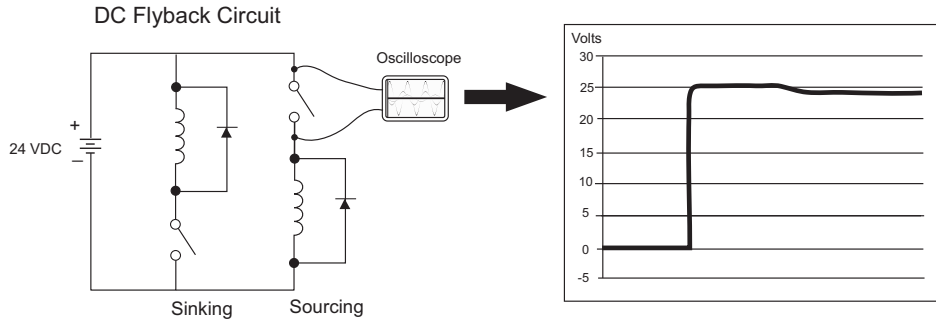

Many AutomationDirect socketed relays and motor starters have add-on flyback diodes that plug or screw into the base, such as the AD-ASMD-250 protection diode module and 784-4C-SKT-1 socket module shown below. If an add-on flyback diode is not available for your inductive load, an easy way to add one is to use AutomationDirect's DN-D10DR-A diode terminal block, a 600VDC power diode mounted in a slim DIN rail housing.

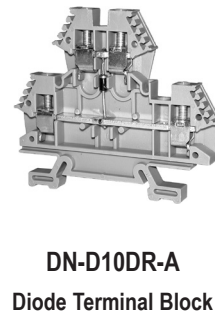

Two more common options for DC coils are Metal Oxide Varistors (MOV) or TVS diodes. These devices should be connected across the driver (CPU output) for best protection as shown below. The optimum voltage rating for the suppressor is the lowest rated voltage available that will NOT conduct at the supply voltage, while allowing a safe margin.

AutomationDirect's ZL-TSD8-24 transorb module is a good choice for 24VDC circuits. It has a bank of 8 uni-directional 30V TVS diodes. Since they are uni-directional, be sure to observe the polarity during installation. MOVs or bi-directional TVS diodes would install at the same location, but have no polarity concerns.



**ZL-TSD8-24**

**Transorb Module**

DC MOV or TVS Diode Circuit

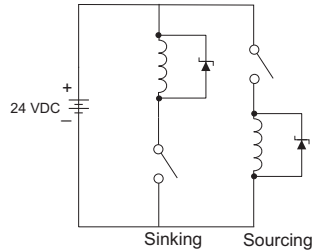

### AC Coils:

Two options for AC coils are MOVs or bi-directional TVS diodes. These devices are most effective at protecting the driver from a transient voltage when connected across the driver (CPU output) but are also commonly connected across the coil. The optimum voltage rating for the suppressor is the lowest rated voltage available that will NOT conduct at the supply voltage, while allowing a safe margin.

AutomationDirect's ZL-TSD8-120 transorb module is a good choice for 120VAC circuits. It is a bank of eight bi-directional 180V TVS diodes.



**ZL-TSD8-120**

**Transorb Module**

AC MOV or Bi-Directional Diode Circuit

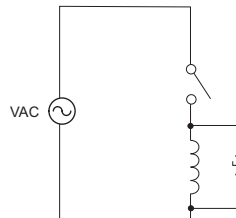

**NOTE:** Manufacturers of devices with coils frequently offer MOV or TVS diode suppressors as an add-on option which mount conveniently across the coil. Before using them, carefully check the suppressor ratings. Just because the suppressor is made specifically for that part does not mean it will reduce the transient voltages to an acceptable level.

For example, a MOV or TVS diode rated for use on 24-48 VDC coils would need to have a high enough voltage rating to NOT conduct at 48V. That suppressor might typically start conducting at roughly 60VDC. If it were mounted across a 24V coil, transients of roughly 84V (if sinking output) or -60V (if sourcing output) could reach the CPU output. Many semiconductor CPU outputs cannot tolerate such levels.