

Input Specifications	
Input Channels	4
Module Signal Input Range	0-10VDC
Signal Resolution	16-bit
Resolution Value of LSB (least significant bit)	0-10VDC = 152µV per count (1LSB = 1 count)
Data Range	0-65535 counts
Input Type	Single-ended (1 common)
Maximum Continuous Overload	±100V
Input Impedance	250kΩ (typical)
Filter Characteristics	Low Pass, -3dB @ 60Hz
Sample Duration Time	7ms per channel (does not include ladder scan time)
All Channel Update Rate	50ms
Open Circuit Detection Time	Zero reading within 1s
Conversion Method	Successive approximation
Accuracy vs. Temperature	±25PPM / °C maximum
Maximum Inaccuracy	0.1% of range (including temperature drift)
Linearity Error (end to end)	±0.015% of range Monotonic with no missing codes
Input Stability & Repeatability	±0.015% of range (after 10 min. warm-up)
Full Scale Calibration Error	±0.15% of range maximum
Offset Calibration Error	±0.015% of range maximum
Max Crosstalk	-76dB, of range maximum
External Power Supply Required	24VDC (-20% / + 25%), 35mA

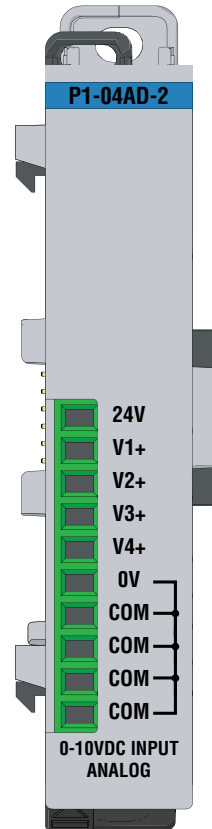

P1-04AD-2 Analog Input

The P1-04AD-2 Voltage Analog Input Module provides four channels for receiving 0-10VDC signals for use with the Productivity1000 system.

Input Specifications	1
General Specifications	2
Terminal Block Specifications	2
Wiring Diagram and Schematic	3
Module Installation Procedure	4
QR Code	4
Wiring Options	5
Module Configuration	5
Linear Scaling	6
Non-Linear Scaling	6
Diagnostic/Status	8
Warning	8

Terminal Block sold separately, (see wiring options on page 5).

Warranty: Thirty-day money-back guarantee. Two-year limited replacement (See www.productivity1000.com for details).

General Specifications	
Operating Temperature	0° to 60°C (32° to 140°F)
Storage Temperature	-20° to 70°C (-4° to 158°F)
Humidity	5 to 95% (non-condensing)
Altitude	2,000 meters max
Pollution Degree	2
Environmental Air	No corrosive gases permitted
Vibration	IEC60068-2-6 (Test Fc)
Shock	IEC60068-2-27 (Test Ea)
Field to Logic Side Isolation	1800VAC applied for 1 second
Insulation Resistance	> 10MΩ @ 500VDC
Heat Dissipation	1400mW
Overvoltage Category	II
Enclosure Type	Open Equipment
Module Location	Any I/O position in a Productivity1000 System
Field Wiring	Removable terminal block (sold separately). Use ZIP Link Wiring System optional See "Wiring Options" on page 5.
Terminal Type (sold separately)	10-position Removable Terminal Block
Weight	58g (2.0 oz)
Agency Approvals	UL 61010-1 and UL 61010-2-201 File E139594, Canada and USA CE (EN 61131-2 EMC, EN 61010-1 and EN 61010-2-201 Safety)*

*See CE Declaration of Conformance for details.

Terminal Block Specifications		
Part Number	P1-10RTB	P1-10RTB-1
Positions	10 Screw Terminals	10 Spring Clamp Terminals
Wire Range	30–16 AWG (0.051–1.31 mm ²) Solid / Stranded Conductor 3/64 in (1.2 mm) Insulation Max. 1/4 in (6–7 mm) Strip Length	28–16 AWG (0.081–1.31 mm ²) Solid / Stranded Conductor 3/64 in (1.2 mm) Insulation Max. 19/64 in (7–8 mm) Strip Length
Conductors	"USE COPPER CONDUCTORS, 75°C" or equivalent.	
Screw Driver	0.1 in (2.5 mm) Maximum*	
Screw Size	M2	N/A
Screw Torque	2.5 lb-in (0.28 N-m)	N/A

*Recommended Screw Driver TW-SD-MSL-1

P1-04AD-2 Schematic

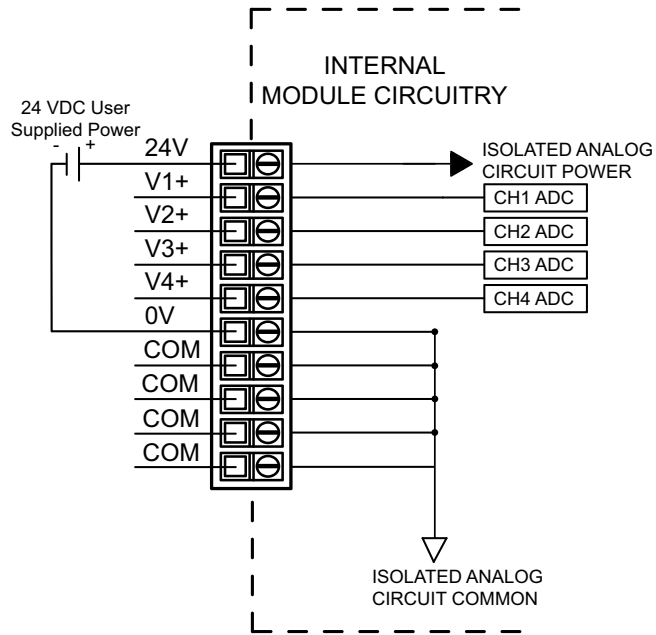

P1-04AD-2 Wiring Diagram

Voltage Input Circuits

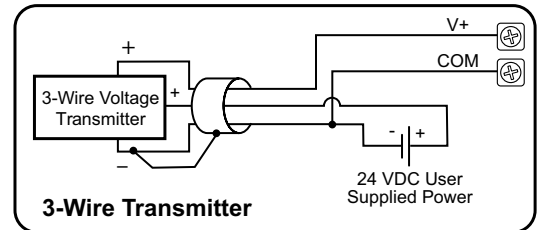
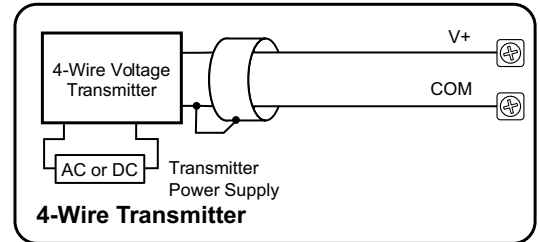

Module Installation

QR Code

WARNING: Do not add or remove modules with field power applied.

Step One: With latch in "locked" position, align connectors on the side of each module and stack by pressing together. Click indicates lock is engaged.

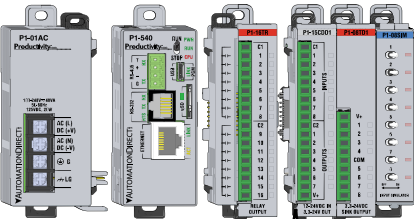

Ensure all latches are secure after modules are connected.

Step Two: Attach field wiring using the removable terminal block or ZIPLink wiring system.

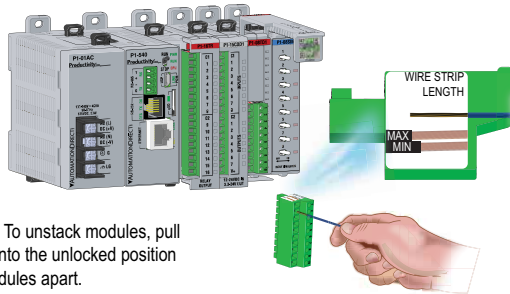

Step Three: To unstack modules, pull locking latch up into the unlocked position and then pull modules apart.

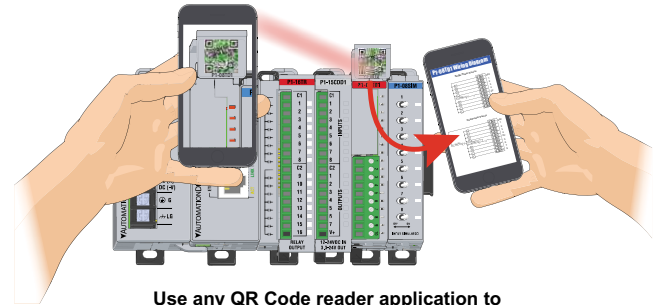
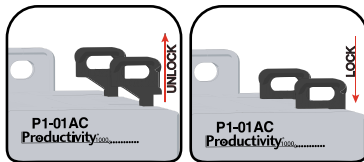

Use any QR Code reader application to display the module's product insert.

Module Configuration

Wiring Options

1 ZIPLink Feed Through Modules and Cables¹

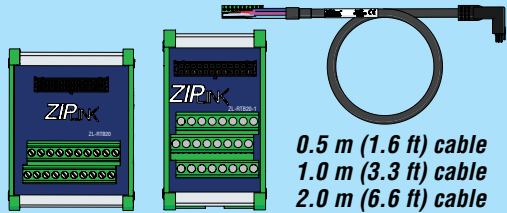

0.5 m (1.6 ft) cable
1.0 m (3.3 ft) cable
2.0 m (6.6 ft) cable



ZL-RTB20
ZL-RTB20-1

ZL-P1-CBL10
ZL-P1-CBL10-1
ZL-P1-CBL10-2

2 Terminal Block with pigtail cable

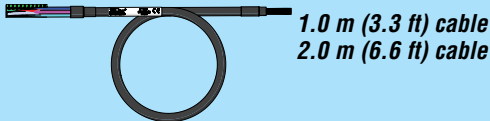

1.0 m (3.3 ft) cable
2.0 m (6.6 ft) cable

ZL-P1-CBL10-1P
ZL-P1-CBL10-2P

3 Screw Terminal Block only

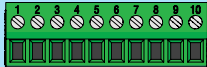

P1-10RTB
(Quantity 1)

4 Spring Clamp Terminal Block only

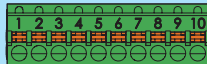

P1-10RTB-1
(Quantity 1)

5 Accessories²



ZL-RTB-COM
TW-SD-SL-1
TW-SD-MSL-1

1. Cable + ZIPLink Module = Complete System
2. ZL-RTB-COM provides a common connection point for power or ground

Using the Hardware Configuration tool in the Productivity Suite programming software, drag and drop the P1-04AD-2 module into the configuration.

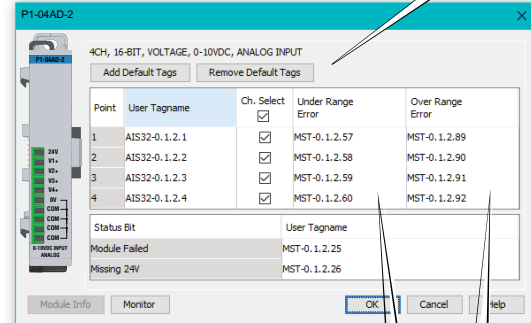

The "Under Range Error" bit for each channel activates for a signal around 0V ± offset error.
The "Over Range Error" bit for each channel activates for a signal around 10V ± gain error.

Linear Scaling

The Scale (Linear) function can be used to:

- Convert an application specific range to range which is native to the analog output module.
- Make other linear conversions in ranges appropriate to the application.

Select the Input and Output tags appropriate for the application. Convert raw input signals to engineering units for use in the program, or convert engineering units to output signals for control purposes

Input	Output
0	220
65535	12500

Non-Linear Scaling

The Scale (Non-Linear) function can be used for Non-Linear applications.

Input value	Desired Output
0	0
1	5
2	1
3	1.55
4	2.25
5	3.07
6	4
6.5	5
7	7
0	0
0	0
0	0
0	0
0	0
0	0

Enter actual output values for each input value break point.

WARNING: To minimize the risk of potential safety problems, you should follow all applicable local and national codes that regulate the installation and operation of your equipment. These codes vary from area to area and it is your responsibility to determine which codes should be followed, and to verify that the equipment, installation, and operation are in compliance with the latest revision of these codes.

Equipment damage or serious injury to personnel can result from the failure to follow all applicable codes and standards. We do not guarantee the products described in this publication are suitable for your particular application, nor do we assume any responsibility for your product design, installation, or operation.

If you have any questions concerning the installation or operation of this equipment, or if you need additional information, please call Technical Support at 770-844-4200.

This publication is based on information that was available at the time it was printed. At AutomationDirect.com® we constantly strive to improve our products and services, so we reserve the right to make changes to the products and/or publications at any time without notice and without any obligation. This publication may also discuss features that may not be available in certain revisions of the product.

Diagnostic/Status

Diagnostic/Status	
<i>Under Range Error</i>	1 bit per channel
<i>Over Range Error</i>	1 bit per channel
<i>Module Failed</i>	1 bit per module
<i>Missing 24V</i>	1 bit per module

Document Name	Edition/Revision	Date
P1-04AD-2-DS	1st Edition, Rev A	2/6/2023

Copyright 2022, AutomationDirect.com Incorporated/All Rights Reserved Worldwide