

RTD Input Specifications	
<b>Inputs Channels</b>	4 Differential
<b>Data Format</b>	Floating Point
<b>Max. Common Mode Voltage</b>	5VDC
<b>Common Mode Rejection</b>	-100dB min. @ DC, -100dB min. @ 50/60 Hz*
<b>Absolute Maximum Ratings</b>	Fault Protected Inputs to $\pm 50V$
<b>Internal Resolution</b>	16-bit, $\pm 0.1^{\circ}C$ or $^{\circ}F$
<b>RTD Input Ranges</b>	Pt100 $-200^{\circ}C/850^{\circ}C$ ( $-328^{\circ}F/1562^{\circ}F$ ) Pt1000 $-200^{\circ}C/595^{\circ}C$ ( $-328^{\circ}F/1103^{\circ}F$ ) JPt100 $-100^{\circ}C/450^{\circ}C$ ( $-148^{\circ}F/842^{\circ}F$ ) 10 $\Omega$ Cu. $-200^{\circ}C/260^{\circ}C$ ( $-328^{\circ}F/500^{\circ}F$ ) 25 $\Omega$ Cu. $-200^{\circ}C/260^{\circ}C$ ( $-328^{\circ}F/500^{\circ}F$ ) 120 $\Omega$ Ni. $-80^{\circ}C/260^{\circ}C$ ( $-112^{\circ}F/500^{\circ}F$ )
<b>RTD Linearization</b>	Automatic
<b>Excitation Current (all ranges)</b>	210 $\mu A$
<b>Accuracy vs. Temperature</b>	$\pm 10$ ppm per $^{\circ}C$ (maximum)
<b>Warm-up Time</b>	2 minutes for $\pm 0.2\%$ repeatability
<b>Maximum Inaccuracy*</b>	$\pm 1^{\circ}C$ maximum @ 16.7 Hz $\pm 3^{\circ}C$ maximum @ 470Hz $\pm 5^{\circ}C$ maximum on Cu10 & Cu25
<b>Sample Duration (Single channel update rate)</b>	Dependent on digital filter settings- 200ms @ 16.7 Hz, 90ms @ 470Hz
<b>Filter Characteristics</b>	Digital Filter cutoff frequencies: 16.7 Hz, 470Hz
<b>All Channel Update Rate</b>	Single channel update rate times the number of enabled channels
<b>Open Circuit Detection Time</b>	Burnout detect within 2s
<b>Conversion Method</b>	Sigma-Delta
<b>External DC Power Required</b>	None

\*NOTE: Excluding RTD error, including temperature drift

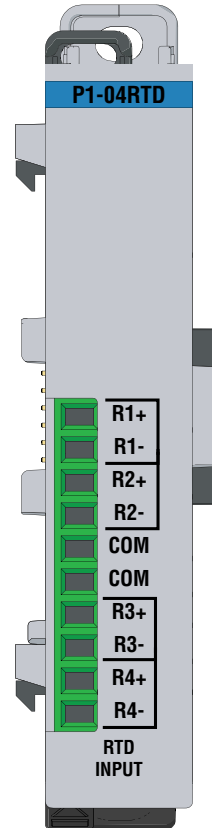

## P1-04RTD Analog Input

The P1-04RTD Input Module provides four differential channels for receiving RTD and resistance input signals for use with the Productivity1000 system.

RTD Input Specifications	1
General Specifications	2
Terminal Block Specifications	2
Wiring Diagram and Schematic	3
Module Installation Procedure	4
QR Code	4
Wiring Options	5
Module Configuration	5
Resistance Input Specifications	6
Diagnostics	6
Typical Application Example	7
Warning	8

Warranty: Thirty-day money-back guarantee. Two-year limited replacement (See [www.productivity1000.com](http://www.productivity1000.com) for details).

General Specifications	
<b>Operating Temperature</b>	0° to 60°C (32° to 140°F)
<b>Storage Temperature</b>	-20° to 70°C (-4° to 158°F)
<b>Humidity</b>	5 to 95% (non-condensing)
<b>Environmental Air</b>	No corrosive gases permitted
<b>Vibration</b>	IEC60068-2-6 (Test Fc)
<b>Shock</b>	IEC60068-2-27 (Test Ea)
<b>Field to Logic Side Isolation</b>	1800VAC applied for 1 second
<b>Heat Dissipation</b>	100mW
<b>Enclosure Type</b>	Open Equipment
<b>Module Location</b>	Any I/O position in a Productivity1000 System
<b>Field Wiring</b>	Removable terminal block (included). The P1-04RTD module is not compatible with the ZIPLink wiring system.
<b>EU Directive</b>	See the "EU Directive" topic in the Productivity Suite Help File. Information can also be obtained at: <a href="http://www.productivity1000.com">www.productivity1000.com</a>
<b>Connector Type (included)</b>	10-position Removable Terminal Block
<b>Weight</b>	60g (2.1 oz)
<b>Agency Approvals</b>	UL 61010-1 and UL 61010-2-201 File E139594, Canada and USA CE (EN 61131-2 EMC, EN 61010-1 and EN 61010-2-201 Safety)*

\*See CE Declaration of Conformance for details.

Terminal Block Specifications		
Part Number	P1-10RTB	P1-10RTB-1
<b>Positions</b>	10 Screw Terminals	10 Spring Clamp Terminals
<b>Wire Range</b>	30–16 AWG (0.051–1.31 mm <sup>2</sup> ) Solid / Stranded Conductor 3/64 in (1.2 mm) Insulation Max. 1/4 in (6–7 mm) Strip Length	28–16 AWG (0.081–1.31 mm <sup>2</sup> ) Solid / Stranded Conductor 3/64 in (1.2 mm) Insulation Max. 19/64 in (7–8 mm) Strip Length
<b>Conductors</b>	"USE COPPER CONDUCTORS, 75°C" or equivalent.	
<b>Screw Driver</b>	0.1 in (2.5 mm) Maximum*	
<b>Screw Size</b>	M2	N/A
<b>Screw Torque</b>	2.5 lb-in (0.28 N-m)	N/A

\*Recommended Screw Driver TW-SD-MSL-1

# P1-04RTD Schematic

# P1-04RTD Wiring Diagram

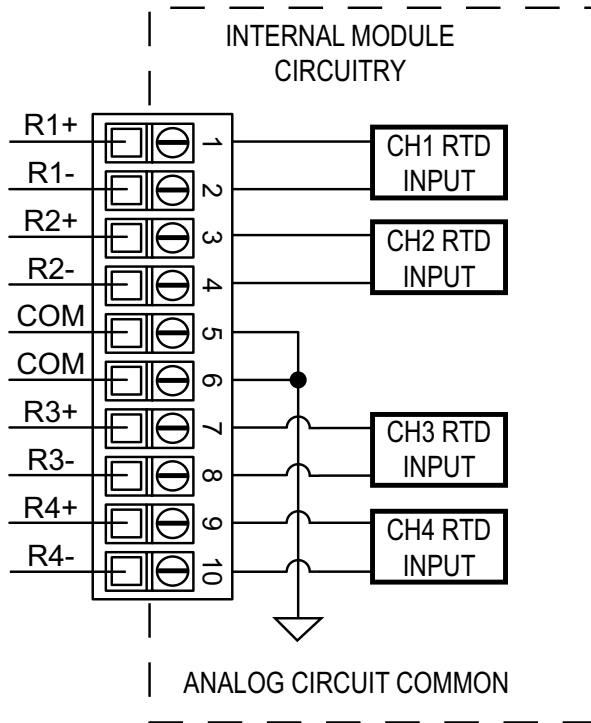

## Resistance Input

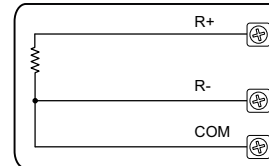

1. R+, R-, and COM wires to an RTD must be equal length and type. Refer to RTD manufacturers

## RTD Input Circuits

### 2-wire RTD

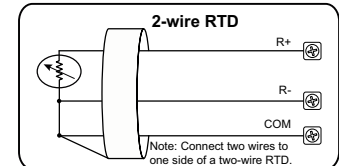

2. For 2-wire RTD, attach a third wire to module common.

### 3-wire RTD

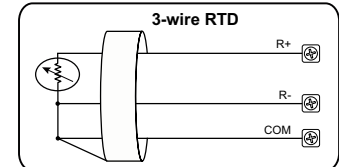

### 4-wire RTD

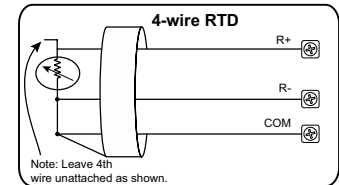

Notes for maximum accuracy:

3. Do not use cable shield as a sensing wire.
4. When applicable, connect shield to RTD common only, otherwise connect to module common only. Do not connect shield to both ends.
5. Jumper unused inputs to common.



# Module Installation

# QR Code

**WARNING:** Do not add or remove modules with field power applied.

**Step One:** With latch in "locked" position, align connectors on the side of each module and stack by pressing together. Click indicates lock is engaged.

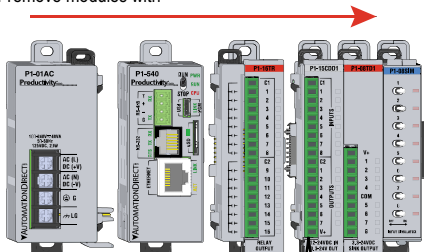

**Step Two:** Attach field wiring using the removable terminal block or ZIPLink wiring system.

Check all latches are secure after modules are connected.

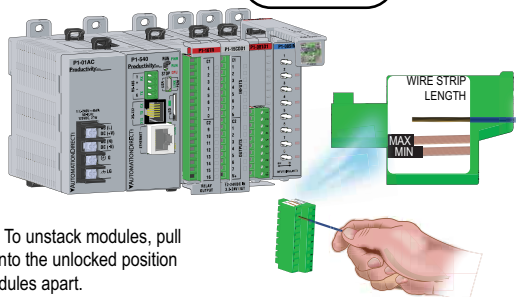

**Step Three:** To unstack modules, pull locking latch up into the unlocked position and then pull modules apart.

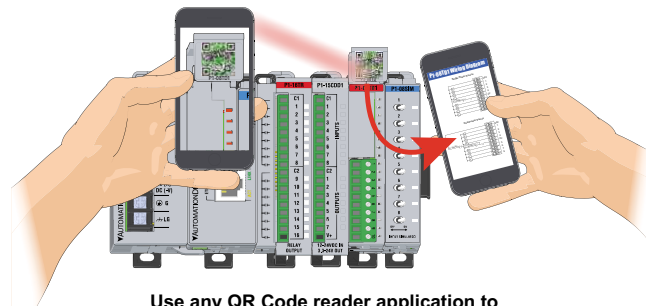
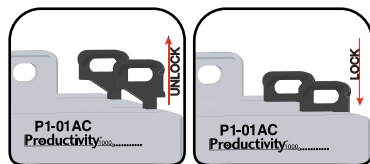

Use any QR Code reader application to display the module's product insert.

# Module Configuration

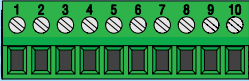
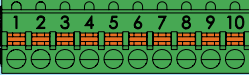
Wiring Options	
<b>1</b> <b>Screw Terminal Block (included)</b> 	P1-10RTB (Quantity 1)
<b>2</b> <b>Spring Clamp Terminal Block</b> 	P1-10RTB-1 (Quantity 1)

Using the Hardware Configuration tool in the Productivity Suite programming software, drag and drop the P1-04RTD module into the base configuration. Specify *Temperature Scale* and *Burnout Detection*, and use the drop down menu to select *module range* and resolution. If desired, assign a *User Tagname* to each output point channel selected and to each *Status Bit Item*.

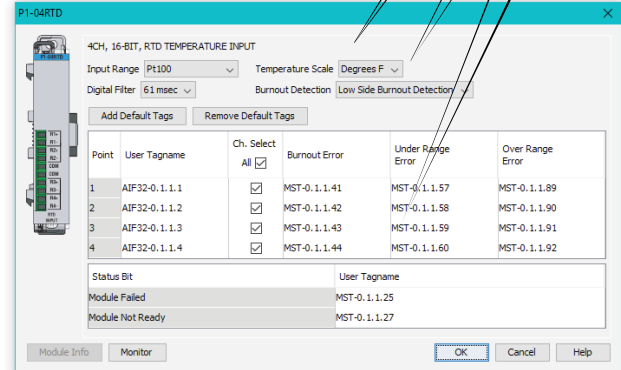

<b>Resistance Input Specifications</b>	
<b>Internal Resolution</b>	16-bit, 0.0015% of full scale range in ohms
<b>Resistance Input Ranges and Resolution</b>	0 – 10,000 $\Omega$ Resolution 1 $\Omega$
	0 – 6,250 $\Omega$ Resolution 0.1 $\Omega$
	0 – 3,125 $\Omega$ Resolution 0.1 $\Omega$
	0 – 1,562.5 $\Omega$ Resolution 0.1 $\Omega$
	0 – 781.25 $\Omega$ Resolution 0.1 $\Omega$
	0 – 390.625 $\Omega$ Resolution 0.01 $\Omega$
0 – 195.3125 $\Omega$ Resolution 0.01 $\Omega$	
<b>Accuracy vs Temperature</b>	$\pm 25$ ppm per $^{\circ}\text{C}$ (maximum)
<b>Linearity Error (end to end)</b>	$\pm 0.03\%$ 16.7 Hz, $\pm 0.06\%$ 470Hz of full scale range maximum at 25 $^{\circ}\text{C}$ , Monotonic with no missing codes
<b>Maximum Inaccuracy</b>	$\pm 0.10\%$ of full scale range

<b>Diagnostics</b>	
<b>Module Diagnostics Failure</b>	1 bit per module
<b>Module Not Ready</b>	1 bit per module
<b>Channel Burn-out (RTD only)</b>	1 bit per channel
<b>Under-range (RTD only)</b>	1 bit per channel
<b>Over-range</b>	1 bit per channel

# Typical Application Example

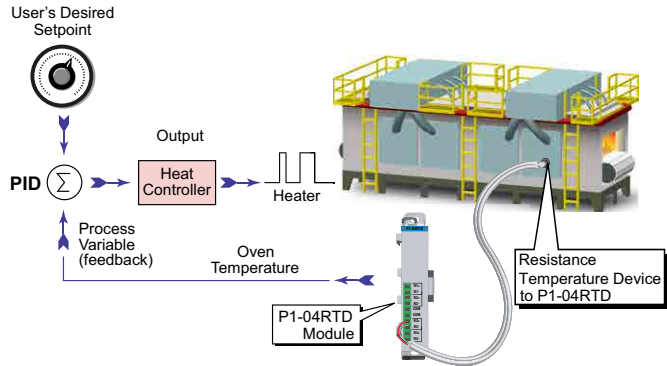

**WARNING:** To minimize the risk of potential safety problems, you should follow all applicable local and national codes that regulate the installation and operation of your equipment. These codes vary from area to area and it is your responsibility to determine which codes should be followed, and to verify that the equipment, installation, and operation are in compliance with the latest revision of these codes.

***Equipment damage or serious injury to personnel can result from the failure to follow all applicable codes and standards. We do not guarantee the products described in this publication are suitable for your particular application, nor do we assume any responsibility for your product design, installation, or operation.***

If you have any questions concerning the installation or operation of this equipment, or if you need additional information, please call Technical Support at 770-844-4200.

This publication is based on information that was available at the time it was printed. At AutomationDirect.com® we constantly strive to improve our products and services, so we reserve the right to make changes to the products and/or publications at any time without notice and without any obligation. This publication may also discuss features that may not be available in certain revisions of the product.

Document Name	Edition/Revision	Date
P1-04RTD-DS	2nd Edition	9/23/2019

Copyright 2019, AutomationDirect.com Incorporated/All Rights Reserved Worldwide