

INSTALLATION AND WIRING



CHAPTER 5

In This Chapter...

Safety Guidelines	5-2
Introduction	5-5
Dimensions and Installation	5-6
Mounting Guidelines	5-7
Wiring Guidelines	5-14
I/O Module Wiring Options.....	5-16
System Wiring Strategies.....	5-22

Safety Guidelines



NOTE: Products with CE marks perform their required functions safely and adhere to relevant standards as specified by CE directives provided they are used according to their intended purpose and that the instructions in this manual are adhered to. The protection provided by the equipment may be impaired if this equipment is used in a manner not specified in this manual. A listing of our international affiliates is available on our Web site at <http://www.automationdirect.com>.



WARNING: Providing a safe operating environment for personnel and equipment is your responsibility and should be your primary goal during system planning and installation. Automation systems can fail and may result in situations that can cause serious injury to personnel or damage to equipment. Do not rely on the automation system alone to provide a safe operating environment. You should use external electromechanical devices, such as relays or limit switches, that are independent of the CPU application to provide protection for any part of the system that may cause personal injury or damage. Every automation application is different, so there may be special requirements for your particular application. Make sure you follow all national, state, and local government requirements for the proper installation and use of your equipment.

Plan for Safety

The best way to provide a safe operating environment is to make personnel and equipment safety part of the planning process. You should examine every aspect of the system to determine which areas are critical to operator or machine safety. If you are not familiar with CPU system installation practices, or your company does not have established installation guidelines, you should obtain additional information from the following sources.

- NEMA — The National Electrical Manufacturers Association, located in Washington, D.C., publishes many different documents that discuss standards for industrial control systems. You can order these publications directly from NEMA. Some of these include:
 - ICS 1, General Standards for Industrial Control and Systems
 - ICS 3, Industrial Systems
 - ICS 6, Enclosures for Industrial Control Systems
- NEC — The National Electrical Code provides regulations concerning the installation and use of various types of electrical equipment. Copies of the NEC Handbook can often be obtained from your local electrical equipment distributor or your local library.
- Local and State Agencies — many local governments and state governments have additional requirements above and beyond those described in the NEC Handbook. Check with your local Electrical Inspector or Fire Marshall office for information.

Three Levels of Protection



WARNING: The control program must not be the only form of protection for any problems that may result in a risk of personal injury or equipment damage.

The publications mentioned provide many ideas and requirements for system safety. At a minimum, you should follow these regulations. Also, you should use the following techniques, which provide three levels of system control.

1. Orderly system shutdown sequence in the CPU control program.
2. Mechanical disconnect for output module power.
3. Emergency stop switch for disconnecting system power.

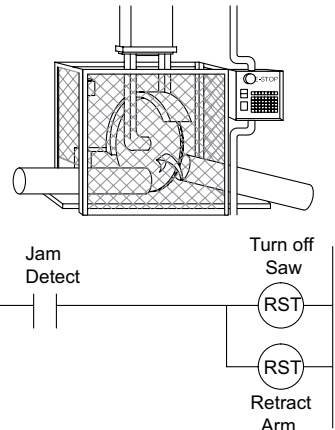

Orderly System Shutdown

The first level of fault detection is ideally the CPU control program, which can identify machine problems. Certain shutdown sequences should be performed. These types of problems are usually things such as jammed parts, etc. that do not pose a risk of personal injury or equipment damage.

System Power Disconnect

You should also use electromechanical devices, such as master control relays and/or limit switches, to prevent accidental equipment startup at an unexpected time. These devices should be installed in a manner that will prevent any machine operations from occurring.

For example, if the machine in the illustration has a jammed part, the CPU control program can turn off the saw blade and retract the arbor. If the operator must open the guard to remove the part, you should also include a bypass switch that disconnects all system power any time the guard is opened.

Emergency Stop Circuits

Emergency stop (E-Stop) circuits are a critical part of automation safety. For each machine controlled by a CPU, provide an emergency stop device that is wired outside the CPU and easily accessed by the machine operator.

E-stop devices are commonly wired through a master control relay (MCR) or a safety control relay (SCR) that will remove power from the CPU I/O system in an emergency.

MCRs and SCRs provide a convenient means for removing power from the I/O system during an emergency situation. By de-energizing an MCR (or SCR) coil, power to the input (optional) and output devices is removed. This event occurs when any emergency stop switch opens. However, the CPU continues to receive power and operate even though all its inputs and outputs are disabled.

The MCR circuit could be extended by placing a CPU fault relay (closed during normal CPU operation) in series with any other emergency stop conditions. This would cause the MCR circuit to drop the CPU I/O power in case of a CPU failure (memory error, I/O communications error, etc.).

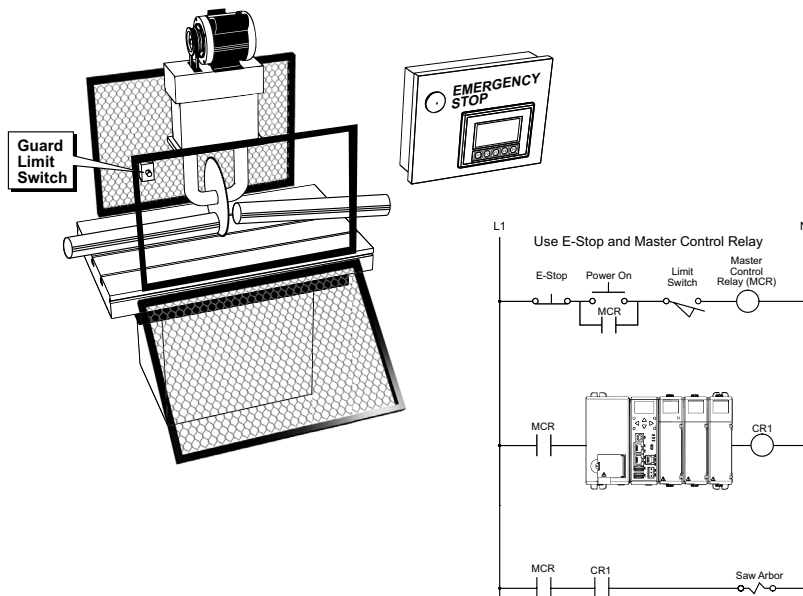

WARNING: For some applications, field device power may still be present on the terminal block even though the CPU is turned off. To minimize the risk of electrical shock, remove all field device power before you expose or remove CPU wiring.

Introduction

Productivity® 2000 Mechanical Design

The Productivity2000 is a modular system that requires a base to accommodate the various modules. Bases are available with 4, 7, 11 and 15 I/O module slots. The bases contain additional dedicated slots for the power supply and the CPU. Each Productivity2000 system requires one CPU module mounted in the controller slot. You can place any I/O module in any I/O slot without power budget or module type restrictions.

Typical Productivity2000 System

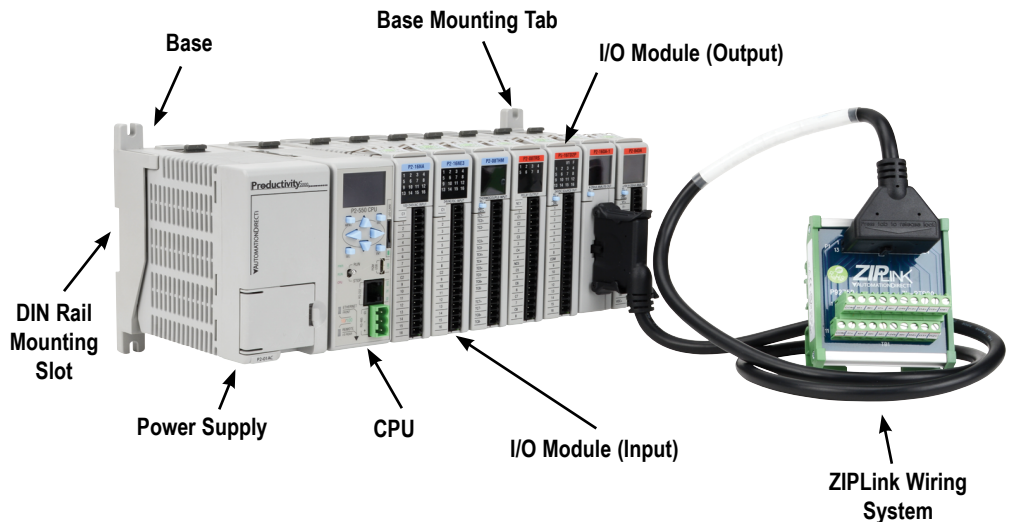

Dimensions and Installation

Before installing the CPU system you will need to know the dimensions of the components considered. These diagrams provide the base dimensions to use in defining your enclosure specifications. Remember to leave room for potential expansion. If you are using other components in your system, refer to the appropriate manual to determine how those units can affect mounting dimensions.

The height dimension is the same for all bases. The depth varies depending on your choice of I/O module. The Productivity® 2000 is designed to be mounted on standard 35mm DIN rail, or it can be surface mounted. Make sure you have followed the installation guidelines for proper spacing.



NOTE: Dimensional drawings for the CPU, power supply and all modules are available on the AutomationDirect.com site.

Base Dimensions, inches [mm]

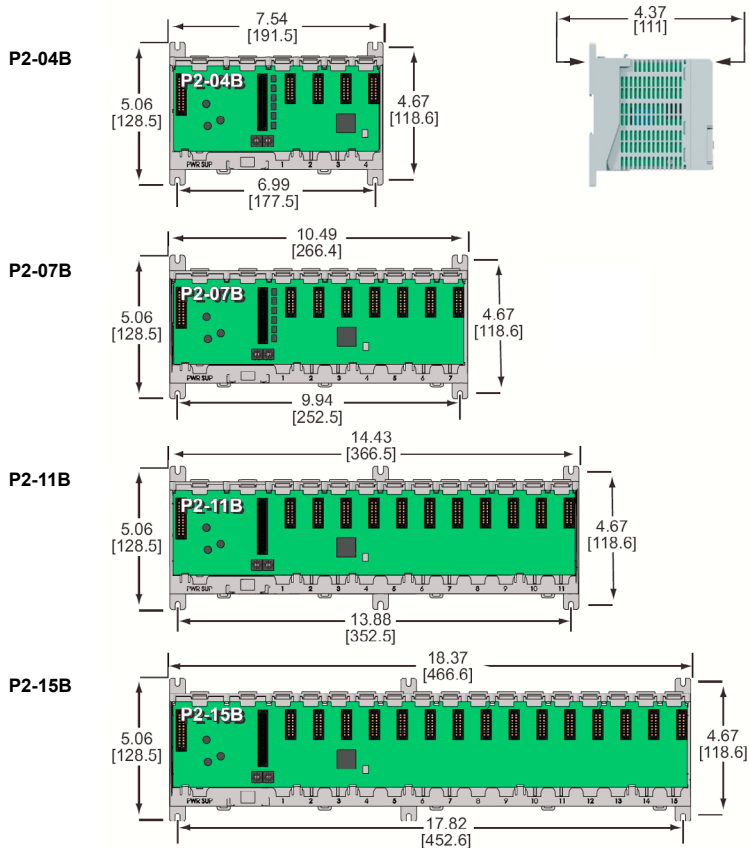

Mounting Guidelines

Enclosures

Your selection of a proper enclosure is important to ensure safe and proper operation of your Productivity® 2000 system. Applications for the Productivity2000 system vary and may require additional hardware considerations. The minimum considerations for enclosures include:

- Conformance to electrical standards
- Protection from the elements in an industrial environment
- Common ground reference
- Maintenance of specified ambient temperature
- Access to the equipment
- Security or restricted access
- Sufficient space for proper installation and maintenance of the equipment

Mounting Position

Mount the bases horizontally, as shown in the illustration on the following page, to provide proper ventilation. Do not mount the bases vertically, upside down, or on a flat horizontal surface.

Mounting Clearances

Provide a minimum clearance of 2 inches (50mm) between the bases and all sides of the enclosure. Allow extra door clearance for operator panels and other door mounted items. There should be a minimum of 3 inches (76mm) clearance between the base and any wire duct, and a minimum of 7.2 inches (183mm) from base to base in a multiple base installation.

Grounding

A good common ground reference (earth ground) is essential for proper operation of the Productivity2000 system. One side of all control circuits, power circuits and the ground lead must be properly connected to earth ground by either installing a ground rod in close proximity to the enclosure or by connecting to the incoming power system ground. There must be a single-point ground (i.e. copper bus bar) for all devices in the enclosure that require an earth ground.

Temperature Considerations

The Productivity2000 system should be installed in an environment operating within the equipment temperature specifications. If the temperature deviates above or below the specification, measures such as cooling or heating the enclosure should be taken to maintain the specification.

Power Considerations

The Productivity2000 system is designed to be powered by 110/240 VAC or various DC voltage ranges, using a Productivity2000 power supply. The Productivity2000 has achieved CE certification without requiring EMF/RFI line noise filters on the AC power supply. Please review the European Union (CE) material in Appendix A for more information.

Panel Layout

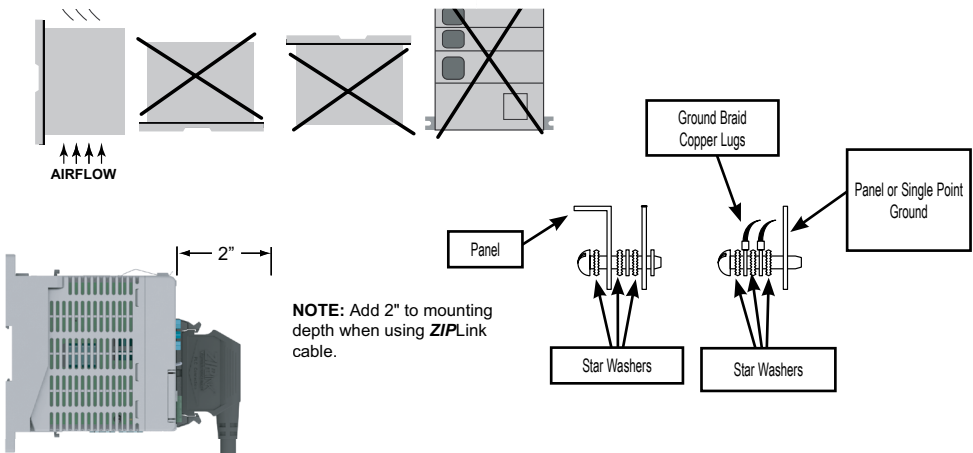
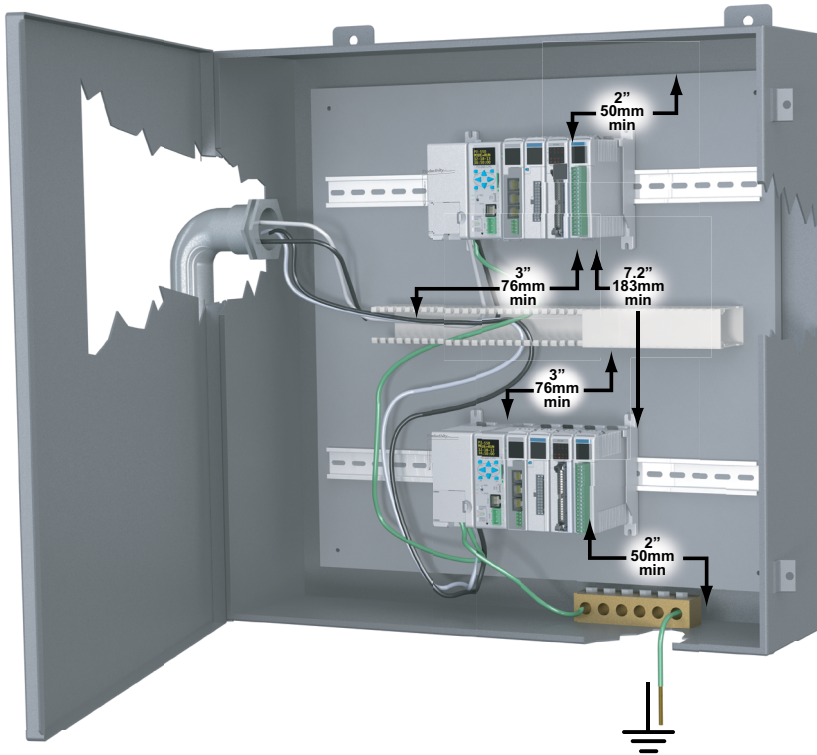

Other Specifications

In addition to the panel layout guidelines, other specifications can affect the installation of a CPU system. Always consider the following:

- Environmental Specifications
- Power Requirements
- Agency Approvals
- Enclosure Selection and Component Dimensions



WARNING: Do not disconnect equipment unless power has been switched off or the area is known to be non-hazardous.

Agency Approvals

Some applications require agency approvals for particular components. The Productivity® 2000 CPU agency approvals are listed below:

- UL (Underwriters' Laboratories, Inc.)
- CUL (Canadian Underwriters' Laboratories, Inc.)
- CE (European Economic Union)



NOTE: See the "EU Directives(CE)" in Appendix A in this manual for more information.

Using Mounting Rails

The Productivity® 2000 bases can be secured to the cabinet using mounting rails. You should use rails that conform to DIN EN standard 50022. We offer a complete line of DIN rail, DINnectors and DIN rail mounted apparatus. These rails are approximately 35mm high, with a depth of 7.5 mm. If you mount the base on a rail, you should also consider using end brackets on each side of the base. The end brackets keep the base from sliding horizontally along the rail. This minimizes the possibility of accidentally pulling the wiring loose.

If you examine the bottom of the base, you'll notice retaining clips. To secure the base to a DIN rail, place the base onto the rail and gently push up on the retaining clips. The clips lock the base onto the rail. To remove the base, pull down on the retaining clips, slightly lift up the base, and pull it away from the rail.

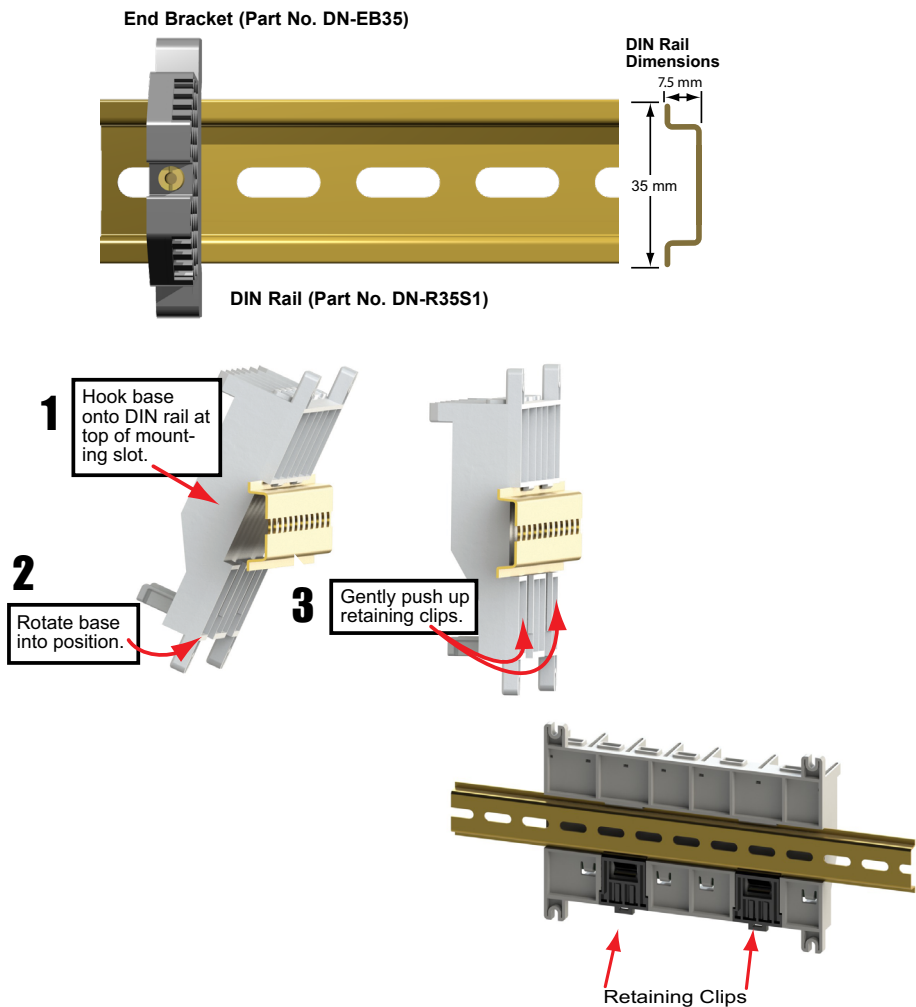

Installing the Power Supply

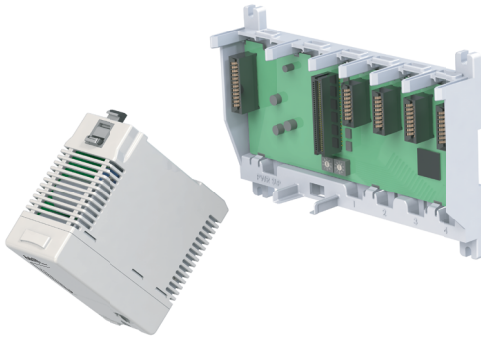

Step One:

Locate the left most socket in the base.

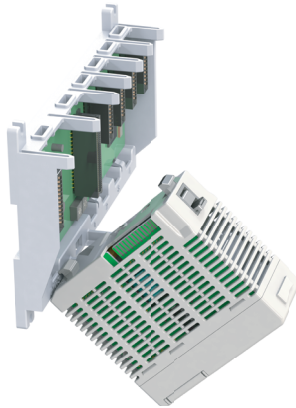

Step Two:

Insert the Power Supply at a 30° angle into the notch located at the bottom of the base and rotate up until seated in socket.

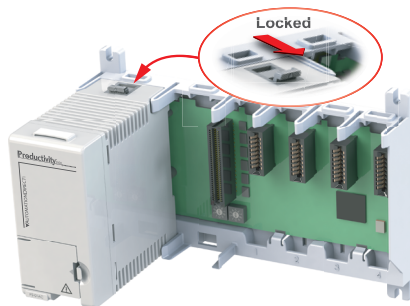

Step Three:

Snap the retaining tab into the locked position.



WARNING: Explosion hazard – Do not connect, disconnect or operate switches while circuit is live unless the area is known to be non-hazardous. Do not hot swap.

Installing the CPU

This installation procedure applies to the P2-550 CPU module assembled in any of the multi-slot bases.

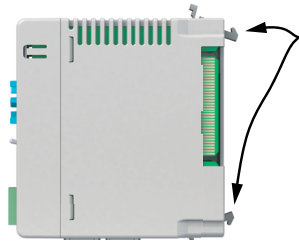

Step One:
Unlock both locking tabs

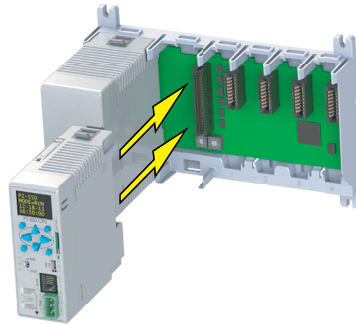

Step Two:
Seat CPU on support platform and push towards base until circuit board is fully engaged into connector.

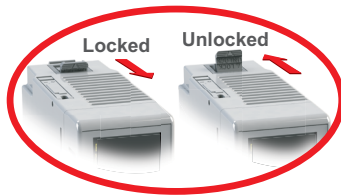

Step Three:
Snap retaining tab into the locked position.



WARNING: Explosion hazard – Do not connect, disconnect or operate switches while circuit is live unless the area is known to be non-hazardous.

Installing the I/O Modules



WARNING: Do not apply field power until the following steps are completed. See hot-swapping procedure for exceptions.

Step One: Align module catch with base slot and rotate module into connector.

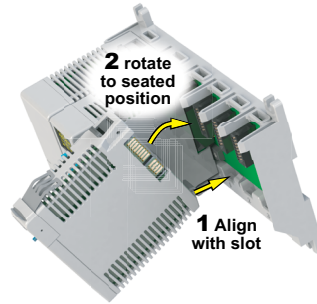

Step Two: Pull top locking tab toward module face. Click indicates lock is engaged.

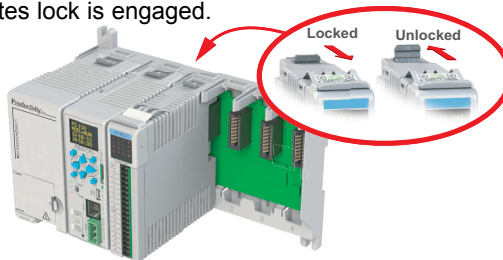

Step Three: Attach field wiring using the removable terminal block or ZIPLink wiring system.

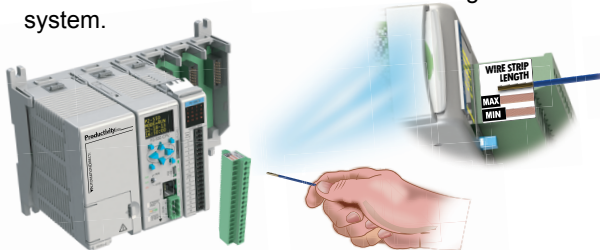

WARNING: Explosion Hazard – Do not connect, disconnect or operate switches while circuit is live unless the area is known to be non-hazardous.



WARNING: The Productivity® 2000 CPU supports Hot Swap. Individual modules can be taken offline, removed, and replaced while the rest of the CPU system continues controlling your process. Hot Swapping is performed with a HOT (powered) system. EXTREME care must be taken to prevent damage to components, terminal blocks, or even personal injury due to a short circuit from the live terminal block. Before attempting to use the hot swap feature, be sure to read the hot swap topic in the Productivity Suite Help file for details on how to plan your installation for use of this powerful feature.

Wiring Guidelines

Wiring to the Power Supply

Connect the power source input wiring to the power supply as shown. The power supply terminals can accept up to 14 AWG solid or stranded wire. Do not over-tighten the terminal screws; the recommended torque is 7 to 9 inch-pounds (0.882 to 1.02 N·m).



WARNING: Once the power wiring is connected, secure the terminal block cover in the closed position. When the cover is open there is a risk of electrical shock if you accidentally touch the connection terminals or power wiring.

Grounding

A good common ground reference (earth ground) is essential for proper operation of the Productivity® 2000 system. One side of all control circuits, power circuits and the ground lead must be properly connected to earth ground by either installing a ground rod in close proximity to the enclosure or by connecting to the incoming power system ground. There must be a single-point ground (i.e. copper bus bar) for all devices in the enclosure that require an earth ground.

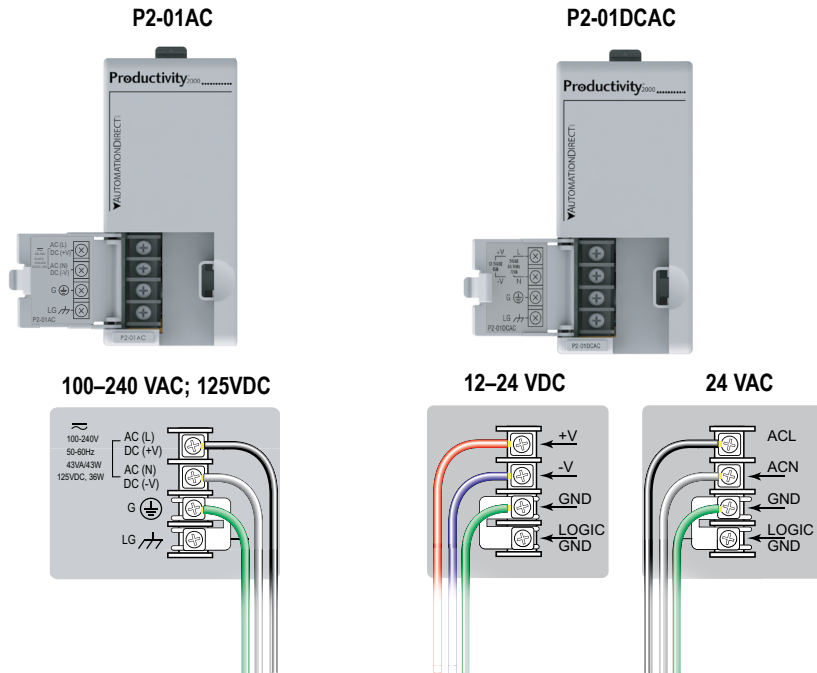

Grounding, continued

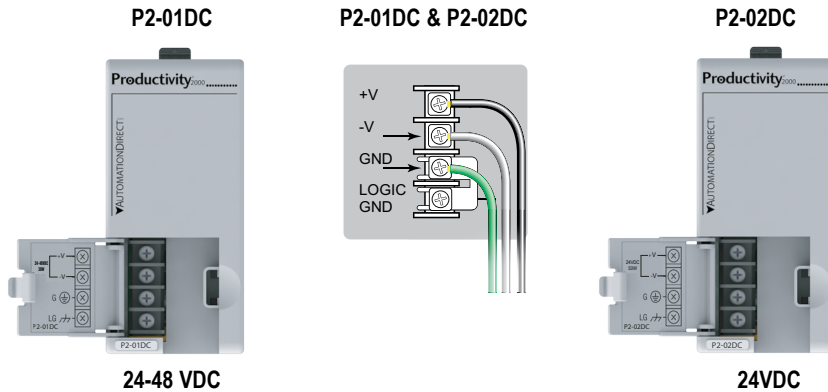

Fuse Protection

Some of the Input and Output I/O module circuits do not have internal fuses. In order to protect your modules, we suggest you add external fuses to your I/O wiring. A fast-blow fuse with a lower current rating than the I/O bank's common current rating can be wired to each common; or a fuse with a rating of slightly less than the maximum current per output point can be added to each output. Refer to the I/O module specifications in Chapter 2 to find the maximum current per output point or per output common. Adding the external fuse does not guarantee the prevention of CPU damage, but it will provide added protection.

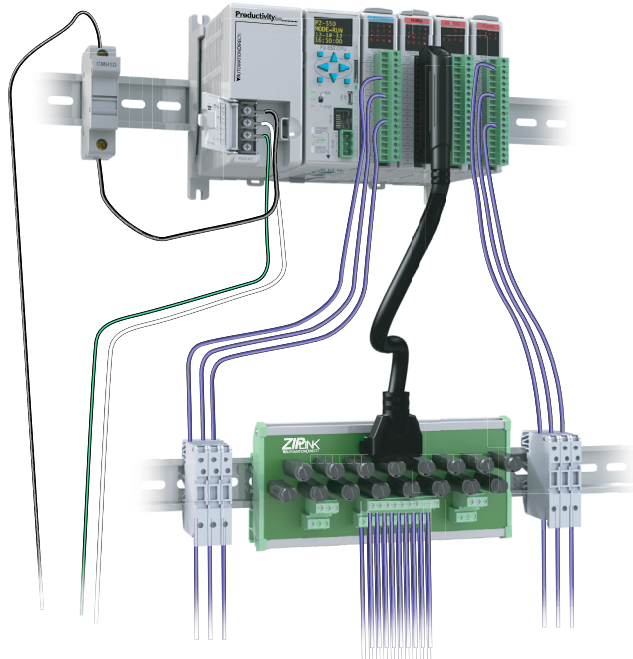

I/O Module Wiring Options

There are two available methods for wiring most I/O modules: The ZIPLink wiring system or hand wiring to the optional removable I/O module terminal blocks.



NOTE: The high-density 16-point ANALOG I/O modules require the use of a Molex style connector wiring system. Thermocouple, RTD and Thermistor modules are not compatible with the ZIPLink system and are shipped with the terminal blocks included.

ZIPLink Wiring System

The ZIPLink wiring system is the recommended method, which allows quick and easy connection using cables that are prewired to the I/O module terminal blocks at one end and plug into a ZIPLink connector module terminal block at the other end. Use the tables on the following page to specify your ZIPLink wiring system.



ZIPLink Pre-Wired Cable

Sample ZIPLink Module



Terminal Block With Pigtail Cable

For most I/O modules you can also purchase ZIPLink pigtail cables.



ZIPLink Pigtail Cable

Input and Output Modules ZIPLink Selections

The following tables show the P2000 modules and the corresponding ZIPLink module to be used.

Productivity2000 Discrete Output Module ZIPLink Selector				
I/O Module		ZIPLink		
Output Module	# of Terms	Component	Module Part No.	Cable Part No.
P2-08TD1S	18	Feedthrough	ZL-RTB20	ZL-P2-CBL18 *
P2-08TD2S			ZL-RTB20 ZL-RTB20-1 ZL-RTB20F-1	
P2-15TD1			ZL-RTB20	
P2-15TD2			ZL-RTB20 ZL-RTB20-1	
P2-08TD1P	18	Feedthrough	ZL-RTB20	
P2-08TD2P				
P2-08TRS				
P2-08TAS				
P2-16TA	18	Feedthrough	ZL-RTB20	
		Fuse	ZL-RFU20 1	
P2-16TD1P	18	Feedthrough	ZL-RTB20	
		Relay (Sinking)	ZL-RRL16-24-1 ZL-RRL16W-24-1 ZL-RRL16F-24-1 ZL-RRL16HDF-24-1	
P2-16TD2P	18	Feedthrough	ZL-RTB20	
		Relay (Sourcing)	ZL-RRL16-24-2 ZL-RRL16W-24-2 ZL-RRL16F-24-2 ZL-RRL16HDF-24-2	
P2-32TD1P	40	Feedthrough	ZL-RTB40	ZL-CBL40 *
P2-32TD2P			ZL-RTB40-1	
P2-16TR	18	Feedthrough	ZL-RTB20	ZL-P2-CBL18 *
		Fuse	ZL-RFU20 1	

* Select the cable length by replacing the * with: Blank = 0.5 m, -1 = 1.0 m, or -2 = 2.0 m.

1 Note: Fuses (5 x 20 mm) are not included. See Edison Electronic Fuse section in our catalog for (5 x 20 mm) fuse. S500 and GMA electronic circuit protection for fast-acting maximum protection. S506 and GMC electronic circuit protection for time-delay performance. Ideal for inductive circuits.

To ensure proper operation, do not exceed the voltage and current rating of ZIPLink module. ZL-RFU20 = 2A per circuit; ZL-RFU40 = 400 mA per circuit.

Analog and Specialty Module ZIPLink Selections

Productivity2000 Discrete Input Module ZIPLink Selector				
I/O Module		ZIPLink		
Input Module	# of Terms	Component	Module Part No.	Cable Part No.
P2-08ND3-1	18	Feedthrough	ZL-RTB20	ZL-P2-CBL18 *
P2-08NE3				
P2-16ND3-1				
P2-16NE3	18	Feedthrough	ZL-RTB20	ZL-P2-CBL18 *
		Sensor/LED	ZL-LTB16-24	
P2-08NAS	18	Feedthrough	ZL-RTB20	ZL-P2-CBL18 *
P2-16NA				
P2-32NE3	40	Feedthrough	ZL-RTB40	ZL-CBL40 *
P2-32ND3-1				

* Select the cable length by replacing the * with: Blank = 0.5 m, -1 = 1.0 m, or -2 = 2.0 m.

Productivity2000 Analog Input Modules ZIPLink Selector				
I/O Module		ZIPLink		
Analog Module	# of Terms	Component	Module	Cable
P2-04AD	18	Feedthrough	ZL-RTB20	ZL-P2-CBL18 *
P2-04AD-1				
P2-04AD-2				
P2-08AD-1				
P2-08AD-2				
P2-08ADL-1				
P2-08ADL-2				
P2-16AD-1	24	Feedthrough	ZL-RTB20	ZL-P2-CBL24 *
P2-16AD-2				
P2-16ADL-1				
P2-16ADL-2				
P2-06RTD	Matched Only	See Note		
P2-08THM	T/C Wire Only			
P2-08NTC	Copper Conductors			

* Select the cable length by replacing the * with: Blank = 0.5 m, -1 = 1.0 m, or -2 = 2.0 m.

Note: These modules are not supported by the ZIPLink wiring system

Analog and Specialty Module ZIPLink Selections

Productivity2000 Analog Output Module ZIPLink Selector				
I/O Module		ZIPLink		
Analog Module	# of Terms	Component	Module	Cable
P2-04DA	18	Feedthrough	ZL-RTB20	ZL-P2-CBL18*
P2-04DA-1				
P2-04DA-2				
P2-04DAL-1				
P2-04DAL-2				
P2-08DA-1				
P2-08DA-2				
P2-08DAL-1				
P2-08DAL-2	24	Feedthrough	ZL-RTB20	ZL-P2-CBL24*
P2-16DA-1				
P2-16DA-2				
P2-16DAL-1				
P2-16DAL-2				

Productivity2000 Analog Input/Output Module ZIPLink Selector				
I/O Module		ZIPLink		
Analog Module	# of Terms	Component	Module	Cable
P2-8AD4DA-1	18	Feedthrough	ZL-RTB20	ZL-P2-CBL18*
P2-8AD4DA-2				

* Select the cable length by replacing the * with: Blank = 0.5 m, -1 = 1.0 m, or -2 = 2.0 m.

Productivity2000 Specialty & Motion Modules ZIPLink Selector				
Module		ZIPLink		
Input Module	# of Terms	Component	Module	Cable
P2-HSI	40	Feedthrough	ZL-RTB40	ZL-CBL40*S
P2-HSO	40	Feedthrough	ZL-RTB40	ZL-CBL40*S
P2-02HSC	See Note			
P2-04PWM	18	Feedthrough	ZL-RTB20	ZL-P2-CBL18 *
P2-08SIM	See Note			
P2-SCM				

* Select the cable length by replacing the * with: Blank = 0.5m, -1 = 1.0m, or -2 = 2.0m.
 Note: These modules are not supported by the ZIPLink wiring system.

Removable Terminal Blocks (Optional)

The hand wiring method consists of purchasing the removable I/O module terminal block (part no. P2-RTB or P2-RTB-1) and hand wiring from the I/O terminal block to a DIN rail mounted terminal block.

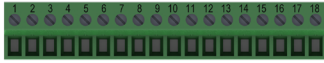

Removable Terminal Block P2-RTB

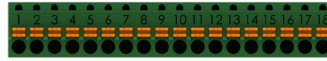

Removable Terminal Block P2-RTB-1

Terminal Block Removal

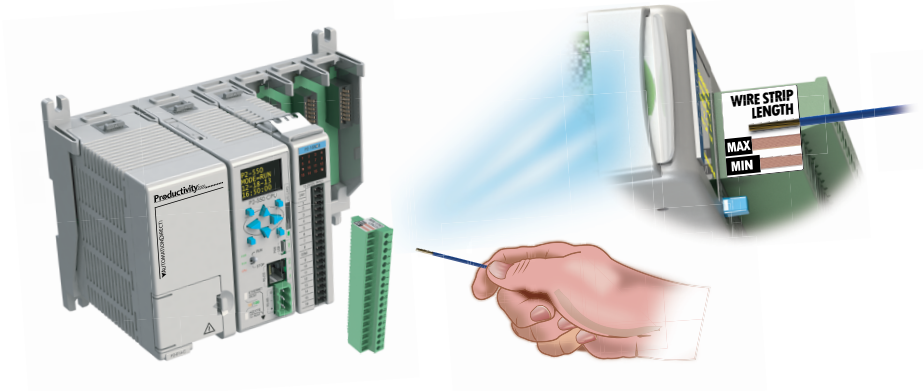

Removable Terminal Block Specifications		
Part Number	P2-RTB	P2-RTB-1
Number of positions	18 screw terminals	18 Spring Clamp terminals
Wire Range	30–16 AWG (0.051–1.31 mm ²) Solid / Stranded conductor 3/64 in. (1.2 mm) insulation maximum 1/4 in (6–7 mm) Strip length	28–16 AWG (0.081–1.31 mm ²) Solid / Stranded Conductor 3/64 in (1.2 mm) insulation maximum 19/64 in (7–8 mm) Strip length
Conductors	USE COPPER CONDUCTORS, 75°C or equivalent	
Screw Driver Width	1/8 in (3.8 mm) maximum	
Screw Size	M2	N/A
Screw Torque	2.5 lb-in (0.28 N-m)	N/A

Planning the I/O Wiring Routes

The following guidelines provide general information on how to wire the I/O connections to Productivity® 2000 modules. For specific information on wiring a particular I/O module refer to the module specifications in Chapter 2.

1. If using removable terminal blocks, follow the wire size guidelines in the I/O modules specifications in Chapter 2.
2. Always use a continuous length of wire. Do not splice wires to attain a needed length.
3. Use the shortest possible wire length.
4. Use wire trays for routing where possible.
5. Avoid running low voltage control wires near high voltage wiring.
6. Avoid confusion by laying input wiring separate from output wiring where possible.
7. To minimize voltage drops when wires must run a long distance, consider using multiple wires for the return line.
8. Avoid running DC wiring in close proximity to AC wiring where possible.
9. Avoid creating sharp bends in the wires; follow accepted Electrical Code standards.

System Wiring Strategies

The Productivity®2000 system is very flexible and will work in many different wiring configurations. By studying this section before actual installation, you can find the best wiring strategy for your application. This will help to lower system cost and wiring errors, and avoid safety problems.

CPU Isolation Boundaries

CPU circuitry is divided into three main regions separated by isolation boundaries, shown in the drawing below. Electrical isolation provides safety, so that a fault in one area does not damage another. The transformer in the power supply provides magnetic isolation between the primary and secondary sides. Optical isolators provide isolation in Input and Output circuits. This isolates logic circuitry from the field side, where factory machinery connects. The discrete inputs are isolated from the discrete outputs because each is isolated from the logic side. Isolation boundaries protect the devices which are connected to the communication ports, such as PCs and HMIs, from power input faults or field wiring faults. When wiring a CPU, it is extremely important to avoid making external connections that connect logic side circuits to any other.

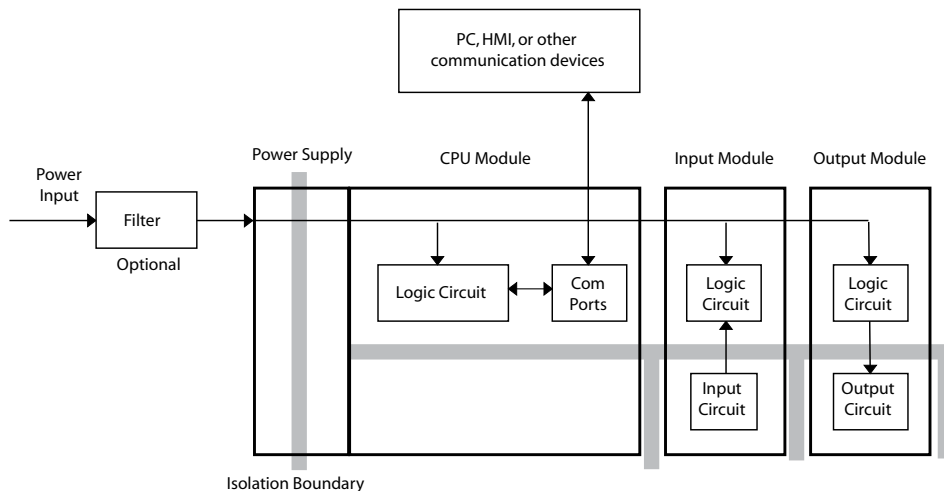

Sinking/Sourcing Concepts

Before wiring field devices to the CPU I/O, it's necessary to have a basic understanding of "sinking" and "sourcing" concepts. Use of these terms occurs frequently in input or output circuit discussions. The purpose of this section is to explain the terms. The short definitions are as follows:

Sinking = Path to supply ground (-) or switching ground

Sourcing = Path to supply source (+) or switching +V

These terms only apply to DC circuits, not AC circuits. Input and output points that are either sinking or sourcing can conduct current in only one direction. This means it is possible to wire the external supply and field device to the I/O point with current trying to flow in the wrong direction, in which case the circuit will not operate.

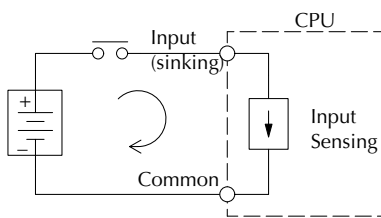

The diagram on the left shows a "sinking" CPU input. To properly connect the external supply, connect it so that the input provides a path to ground (-). Start at the CPU input terminal, follow through the input sensing circuit, exit at the common terminal, and connect the supply (-) to the common terminal.

The switch between the supply (+) and the input completes the circuit. Current flows in the direction of the arrow when the switch is closed. By applying the circuit principle above to the four possible combinations of input/output sinking/sourcing types, we have the four circuits as shown below.

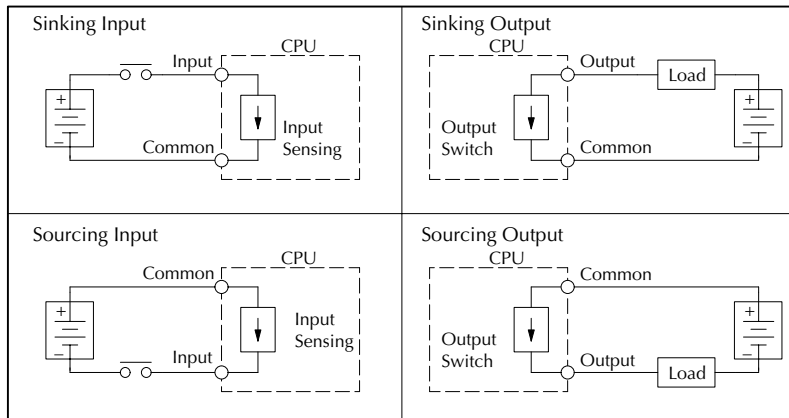

I/O “Common Terminal” Concepts

In order for a CPU I/O circuit to operate, current must enter at one terminal and exit at another. This means at least two terminals are associated with every I/O point. In the figure below, the input or output terminal is the main path for the current. One additional terminal must provide the return path to the power supply.

If there was unlimited module space then every I/O point could have two dedicated terminals as the figure above shows. Providing this level of flexibility is not practical or necessary for most applications. Most I/O point groups share the return path (common) among two or more I/O points. The figure below shows a group (or bank) of four input points which share a common return path. In this way, the four inputs require only five terminals instead of eight.

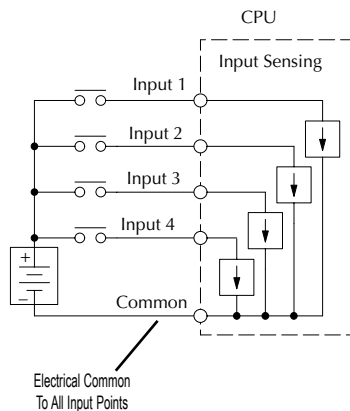
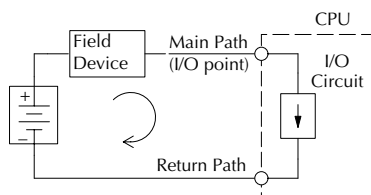

NOTE: In the circuit above, the current in the common path is equal to the sum of the energized channels. This is especially important in output circuits, where larger gauge wire is sometimes needed for the commons.

DC Input Wiring Methods

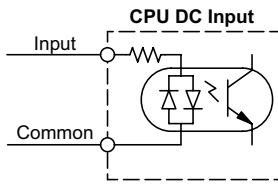

I/O modules with DC inputs can be wired as either sinking or sourcing inputs. The dual diodes (shown in this diagram) allow current to flow in either direction. Inputs grouped by a common point must be either all sinking or all sourcing. DC inputs typically operate in the range of +12-24 VDC.

Sinking Input Sensor (NPN Type) to CPU Sourcing Input

In the following example, a field device has an open-collector NPN transistor output. When energized, it sinks current to ground from the DC input point. The CPU input current is sourced from the common terminal connected to power supply (+).

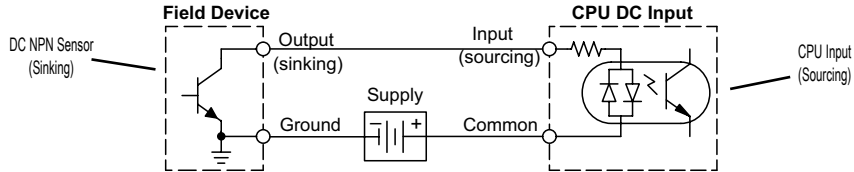

Sourcing Input Sensor (PNP Type) to CPU Sinking Input

In the following example, a field device has an open-emitter PNP transistor output. When energized, it sources current to the CPU input point, which sinks the current to ground. Since the field device loop is sourcing current, no additional power supply is required for the module.

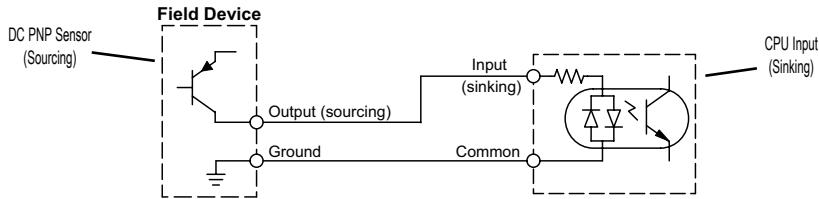

DC Output Wiring Methods

I/O modules with DC output circuits are wired as all current sinking only or current sourcing only depending on which output module part number is used. DC outputs typically operate in the range of +5 - 24 VDC.

CPU Sinking Output to Sourcing Load Device

Many applications require connecting a CPU output point to a DC input on a field device load. This type of connection is made to carry a low-level DC signals.

In the following example, the CPU output point sinks current to ground (common) when energized. The output is connected to a field device load with a sourcing input.

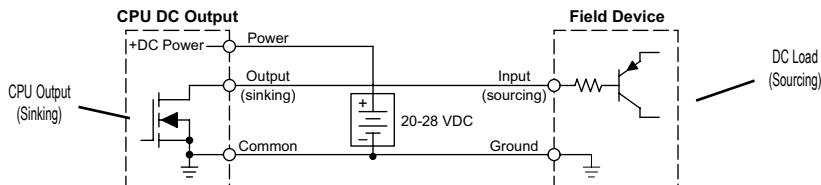

CPU DC Sinking Output to Sinking Load Device

In the example below, a sinking output point is connected to the sinking input of a field device load. In this case, both the CPU output and field device input are sinking type. Since the circuit must have one sourcing and one sinking device, we add sourcing capability to the CPU output by using a pull-up resistor. In the circuit below, we connect R pull-up from the output to the DC output circuit power input.

NOTE: DO NOT attempt to drive a heavy load (>25 mA) with this pull-up method.

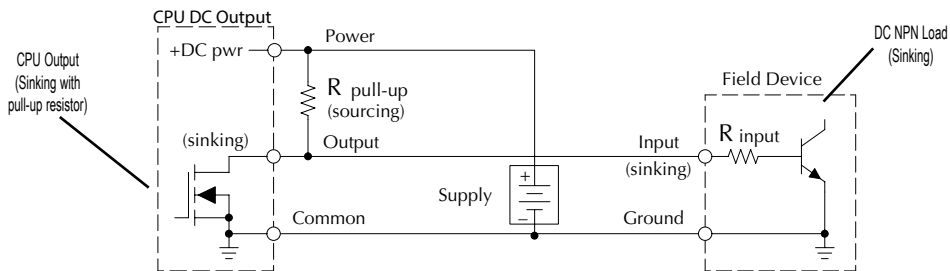

NOTE: Using the pull-up resistor to implement a sourcing output has the effect of inverting the output point logic. In other words, the field device input is energized when the CPU output is OFF, from a ladder logic point-of-view. Your ladder program must comprehend this and generate an inverted output. Or, you may choose to cancel the effect of the inversion elsewhere, such as in the field device.

It is important to choose the correct value of R_{pull-up}. In order to do so, we need to know the nominal input current to the field device (I_{input}) when the input is energized. If this value is not known, it can be calculated as shown (a typical value is 15 mA). Then use I_{input} and the voltage of the external supply to compute R_{pull-up}. Then calculate the power P_{pull-up} (in watts), in order to size R_{pull-up} properly.

$$I_{\text{input}} = \frac{V_{\text{input (turn-on)}}}{R_{\text{input}}}$$

$$R_{\text{pull-up}} = \frac{V_{\text{supply}} - 0.7}{I_{\text{input}}} - R_{\text{input}}$$

$$P_{\text{pull-up}} = \frac{V_{\text{supply}}^2}{R_{\text{pull-up}}}$$

Relay Outputs - Wiring Methods

Relay outputs are available for the Productivity® 2000. Relays are best for the following applications:

- Loads that require higher currents than the solid-state outputs can deliver
- Cost-sensitive applications
- Some output channels need isolation from other outputs (such as when some loads require different voltages than other loads)

Some applications in which NOT to use relays:

- Loads that require currents under 10mA
- Loads which must be switched at high speed or heavy duty cycle.

Relay with Form A contacts

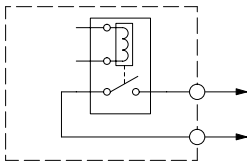

Relay outputs are available in two contact arrangements. Form A type, or SPST (single pole, single throw) type. They are normally open and are the simplest to use. The Form C, or SPDT (single pole, double throw) type has a center contact which moves and a stationary contact on either side. This provides a normally closed contact and a normally open contact.

Relay with Form C contacts

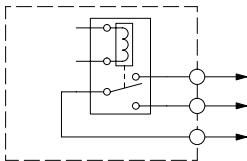

The relays in some relay output modules share common terminals, which connect to the wiper contact in each relay of the bank. Other relay modules have relays which are completely isolated from each other. In all cases, the module drives the relay coil when the corresponding output point is on.

Relay Outputs – Transient Suppression for Inductive Loads in a Control System

The following pages are intended to give a quick overview of the negative effects of transient voltages on a control system and provide some simple advice on how to effectively minimize them. The need for transient suppression is often not apparent to the newcomers in the automation world. Many mysterious errors that can afflict an installation can be traced back to a lack of transient suppression.

What is a Transient Voltage and Why is it Bad?

Inductive loads (devices with a coil) generate transient voltages as they transition from being energized to being de-energized. If not suppressed, the transient can be many times greater than the voltage applied to the coil. These transient voltages can damage CPU outputs or other electronic devices connected to the circuit, and cause unreliable operation of other electronics in the general area. Transients must be managed with suppressors for long component life and reliable operation of the control system.

This example shows a simple circuit with a small 24V/125mA/3W relay. As you can see, when the switch is opened, thereby de-energizing the coil, the transient voltage generated across the switch contacts peaks at 140V!

Example: Circuit with no Suppression

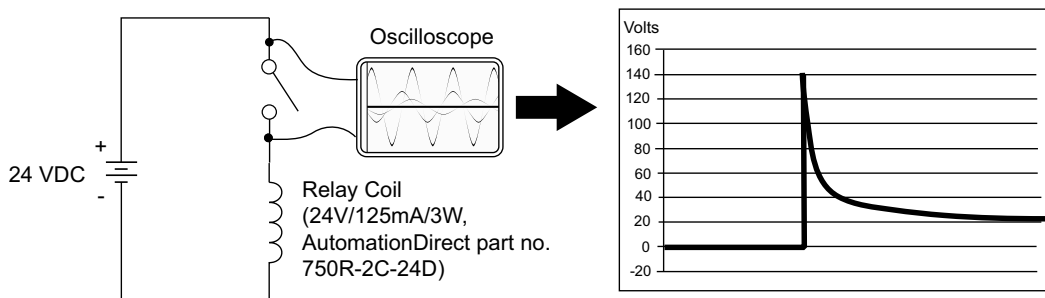

In the same circuit, replacing the relay with a larger 24V/290mA/7W relay will generate a transient voltage exceeding 800V (not shown). Transient voltages like this can cause many problems, including:

- Relay contacts driving the coil may experience arcing, which can pit the contacts and reduce the relay's lifespan.
- Solid state (transistor) outputs driving the coil can be damaged if the transient voltage exceeds the transistor's ratings. In extreme cases, complete failure of the output can occur the very first time a coil is de-energized.
- Input circuits, which might be connected to monitor the coil or the output driver, can also be damaged by the transient voltage.

A very destructive side-effect of the arcing across relay contacts is the electromagnetic interference (EMI) it can cause. This occurs because the arcing causes a current surge, which releases RF energy. The entire length of wire between the relay contacts, the coil, and the power source carries the current surge and becomes an antenna that radiates the RF energy. It will readily couple into parallel wiring and may disrupt the CPU and other electronics in the area. This EMI can make an otherwise stable control system behave unpredictably at times.

CPU's Integrated Transient Suppressors

Although the CPU outputs typically have integrated suppressors to protect against transients, they are not capable of handling them all. It is usually necessary to have some additional transient suppression for an inductive load.

Here is another example using the same 24V/125mA/3W relay used earlier. This example measures the PNP transistor output of a typical CPU, which incorporates an integrated Zener diode for transient suppression. Instead of the 140V peak in the first example, the transient voltage here is limited to about 40V by the Zener diode. While the CPU will probably tolerate repeated transients in this range for some time, the 40V is still beyond the module's peak output voltage rating of 30V.

Example: Small Inductive Load with Only Integrated Suppression

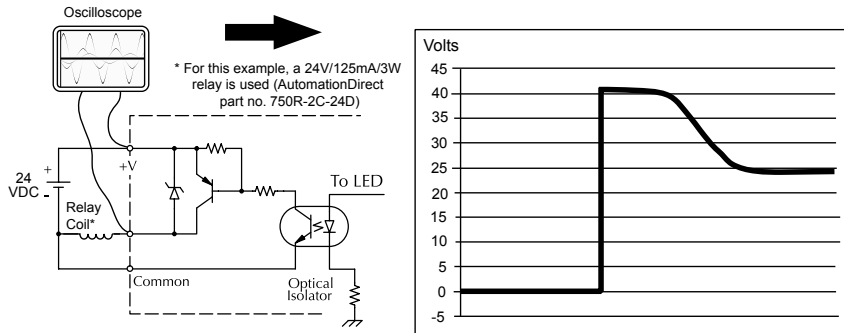

The next example uses the same circuit as above, but with a larger 24V/290mA/7W relay, thereby creating a larger inductive load. As you can see, the transient voltage generated is much worse, peaking at over 50V. Driving an inductive load of this size without additional transient suppression is very likely to permanently damage the CPU output.

Example: Larger Inductive Load with Only Integrated Suppression

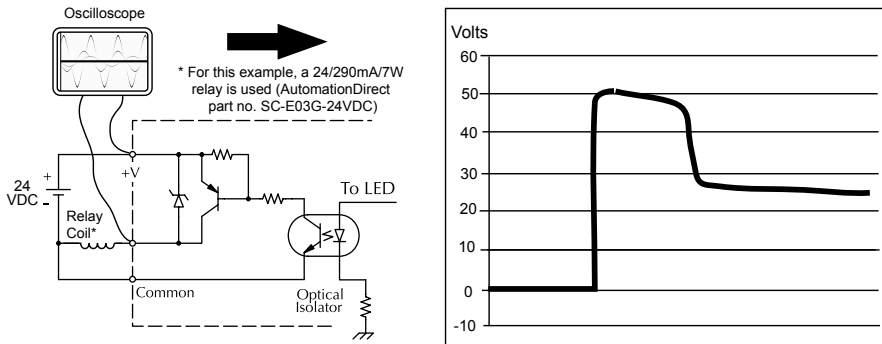

Additional transient suppression should be used in both these examples. If you are unable to measure the transients generated by the connected loads of your control system, using additional transient suppression on all inductive loads would be the safest practice.

Additional Transient Protection Types

DC Coils:

The most effective protection against transients from a DC coil is a flyback diode. A flyback diode can reduce the transient to roughly 1V over the supply voltage, as shown in this example.

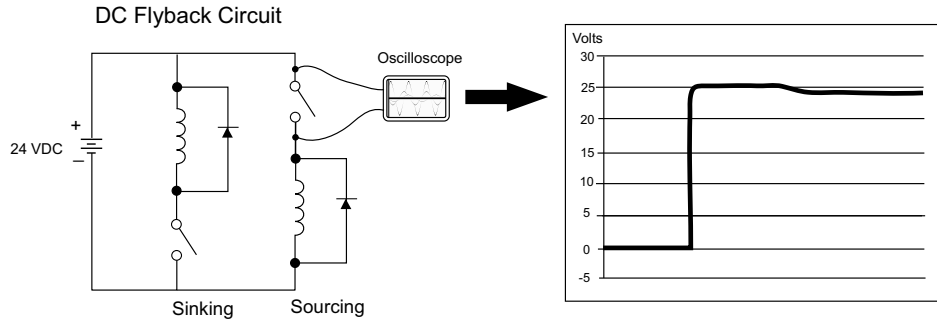

Many AutomationDirect socketed relays and motor starters have add-on flyback diodes that plug or screw into the base, such as the AD-ASMD-250 protection diode module and 784-4C-SKT-1 socket module shown below. If an add-on flyback diode is not available for your inductive load, an easy way to add one is to use AutomationDirect's DN-D10DR-A diode terminal block, a 600VDC power diode mounted in a slim DIN rail housing.

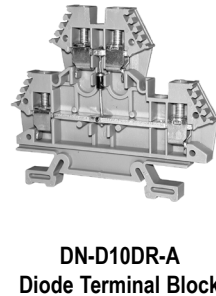

Two more common options for DC coils are Metal Oxide Varistors (MOV) or TVS diodes. These devices should be connected across the driver (CPU output) for best protection as shown below. The optimum voltage rating for the suppressor is the lowest rated voltage available that will NOT conduct at the supply voltage, while allowing a safe margin.

AutomationDirect's ZL-TSD8-24 transorb module is a good choice for 24VDC circuits. It is a bank of 8 uni-directional 30V TVS diodes. Since they are uni-directional, be sure to observe the polarity during installation. MOVs or bi-directional TVS diodes would install at the same location, but have no polarity concerns.



ZL-TSD8-24
Transorb Module

DC MOV or TVS Diode Circuit

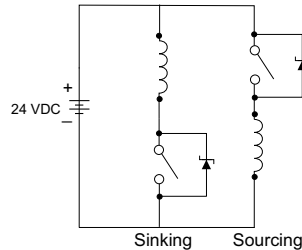

AC Coils:

Two options for AC coils are MOVs or bi-directional TVS diodes. These devices are most effective at protecting the driver from a transient voltage when connected across the driver (CPU output) but are also commonly connected across the coil. The optimum voltage rating for the suppressor is the lowest rated voltage available that will NOT conduct at the supply voltage, while allowing a safe margin.

AutomationDirect's ZL-TSD8-120 transorb module is a good choice for 120VAC circuits. It is a bank of eight bi-directional 180V TVS diodes.



ZL-TSD8-120
Transorb Module

AC MOV or Bi-Directional Diode Circuit

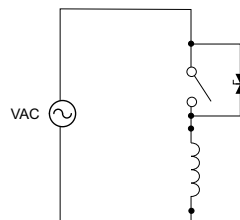

NOTE: Manufacturers of devices with coils frequently offer MOV or TVS diode suppressors as an add-on option which mount conveniently across the coil. Before using them, carefully check the suppressor ratings. Just because the suppressor is made specifically for that part does not mean it will reduce the transient voltages to an acceptable level.

For example, a MOV or TVS diode rated for use on 24-48 VDC coils would need to have a high enough voltage rating to NOT conduct at 48V. That suppressor might typically start conducting at roughly 60VDC. If it were mounted across a 24V coil, transients of roughly 84V (if sinking output) or -60V (if sourcing output) could reach the CPU output. Many semiconductor CPU outputs cannot tolerate such levels.