

**WARNING:** To minimize the risk of potential safety problems, you should follow all applicable local and national codes that regulate the installation and operation of your equipment. These codes vary from area to area and it is your responsibility to determine which codes should be followed, and to verify that the equipment, installation, and operation are in compliance with the latest revision of these codes.

*Equipment damage or serious injury to personnel can result from the failure to follow all applicable codes and standards. We do not guarantee the products described in this publication are suitable for your particular application, nor do we assume any responsibility for your product design, installation, or operation.*

If you have any questions concerning the installation or operation of this equipment, or if you need additional information, please call Technical Support at 770-844-4200.

This publication is based on information that was available at the time it was printed. At AutomationDirect.com<sup>®</sup> we constantly strive to improve our products and services, so we reserve the right to make changes to the products and/or publications at any time without notice and without any obligation. This publication may also discuss features that may not be available in certain revisions of the product.

## Removable Terminal Block Specifications

Part Number	P2-RTB	P2-RTB-1
Number of positions	18 Screw Terminals	18 Spring Clamp Terminals
Wire Range	30–16 AWG (0.051–1.31 mm <sup>2</sup> ) Solid / Stranded Conductor	28–16 AWG (0.081–1.31 mm <sup>2</sup> ) Solid / Stranded Conductor
	3/64 in. (1.2 mm) Insulation Maximum	3/64 in (1.2 mm) Insulation Maximum
	1/4 in (6–7 mm) Strip Length	19/64 in (7–8 mm) Strip Length
Conductors	*USE COPPER CONDUCTORS, 75°C* or equivalent.	
Screw Driver Width	0.1 in (2.5 mm) Maximum*	
Screw Size	M2	N/A
Screw Torque	2.5 lb-in (0.28 N-m)	N/A

\*Recommended Screwdriver TW-SD-MSL-1

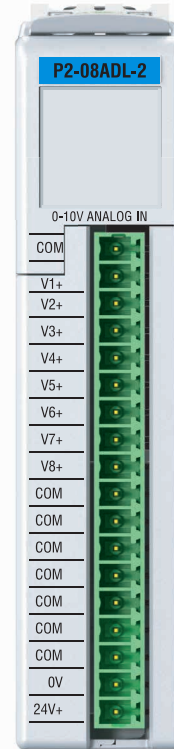

## P2-08ADL-2 Analog Input

The P2-08ADL-2 Low Resolution Voltage Analog Input Module provides eight channels for receiving 0–10 VDC signals for use with the Productivity2000 System.

Warning	1
Removable Terminal Block Specifications	1
General Specifications	2
Input Specifications	2
Wiring Diagram and Schematic	3
Module Installation Procedure	4
QR Code	4
Hot Swap Information	4
Wiring Options	5
Module Configuration	5
Linear Scaling	6
Non-Linear Scaling	6

**Terminal Block sold separately, (see wiring options on page 5).**  
 Warranty: Thirty-day money-back guarantee. Two-year limited replacement. (See [www.productivity2000.com](http://www.productivity2000.com) for details).

## General Specifications

Operating Temperature	0° to 60°C (32° to 140°F)
Storage Temperature	-20° to 70°C (-4° to 158°F)
Humidity	5 to 95% (non-condensing)
Altitude	2,000 meters max
Pollution Degree	2
Environmental Air	No corrosive gases permitted
Vibration	IEC60068-2-6 (Test Fc)
Shock	IEC60068-2-27 (Test Ea)
Field to Logic Side Isolation	1800VAC applied for 1 second
Insulation Resistance	> 10MΩ @ 500VDC
Heat Dissipation	1200mW
Overvoltage Category	II
Enclosure Type	Open Equipment
Module Keying to Backplane	Electronic
Module Location	Any I/O slot in a Productivity2000 System
Field Wiring	Use <b>ZIP</b> Link Wiring System or removable terminal block (not included). See "Wiring Options" on page 5.
Terminal Type	18-position Removable Terminal Block
Weight	100g (3.5 oz)
Agency Approvals	UL 61010-1 and UL 61010-2-201 File E139594, Canada & USA CE (EN 61131-2 EMC, EN 61010-1 and EN 61010-2-201 Safety)*

\*Meets EMC and Safety requirements. See the D.O.C. for details.

## Input Specifications

Input Channels	8
Module Signal Input Range	0–10 VDC
Resolution	13-bit
Data Range	0–8191 counts
Input Type	Single-ended (1 common)
Resolution Value of LSB	0–10 VDC = 1.22 mV per count (1 LSB = 1 Count)
Maximum Continuous Overload	±100VDC
Input Impedance	>150kΩ
Filter Characteristics	Low Pass, -3dB @ 500Hz
Sample Duration Time	6.25 ms per channel (does not include ladder scan time)
All Channel Update Rate	25ms
Accuracy vs. Temperature	±75PPM / °C maximum
Conversion Method	Successive approximation
Maximum Inaccuracy	0.5% of range (including temperature drift)
Linearity Error (end to end)	±0.036% of range Monotonic with no missing codes
Input Stability and Repeatability	±0.024% of range
Full Scale Calibration Error (including offset)	±0.097% of range
Offset Calibration Error	±0.097% of range
Max Crosstalk	4 counts / 0.048% of range
External 24VDC Power Required	24VDC (-20% / +25%), 30mA

## Voltage Input Circuits

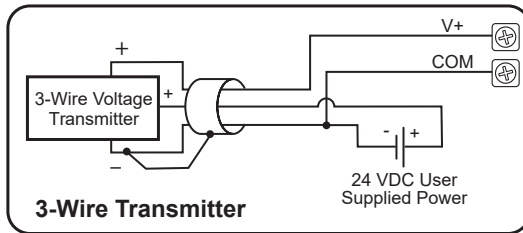
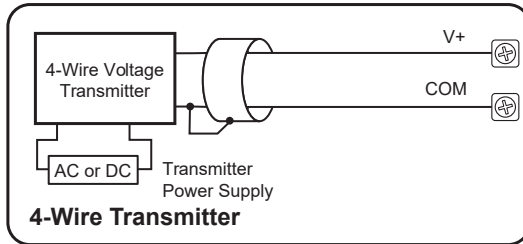

Notes for maximum accuracy:  
1. Jumper unused inputs to common.

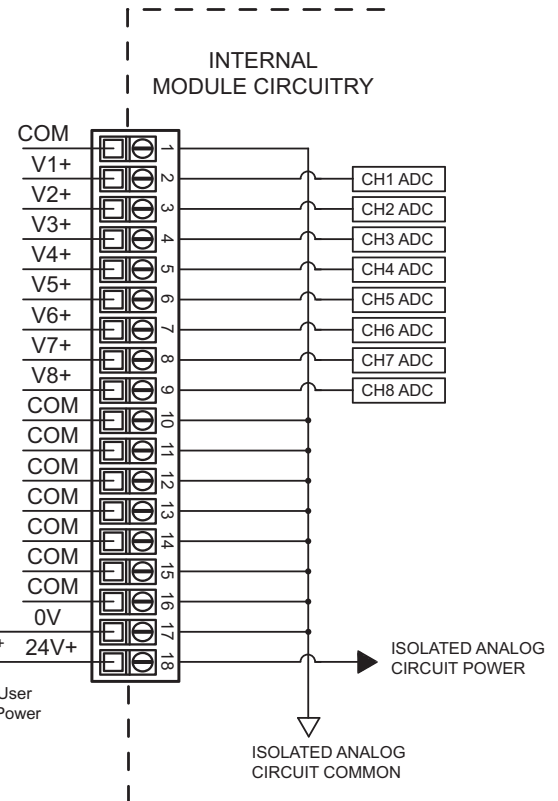
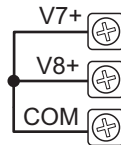

# Module Installation

**WARNING:** Do not apply field power until the following steps are completed. See hot-swapping procedure for exceptions.

**Step One:** Align module catch with base slot and rotate module into connector.

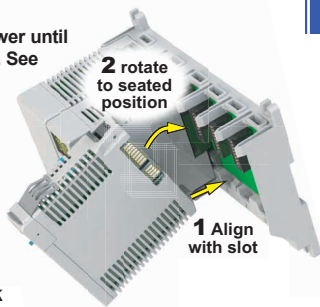

**Step Two:** Pull top locking tab toward module face. Click indicates lock is engaged.

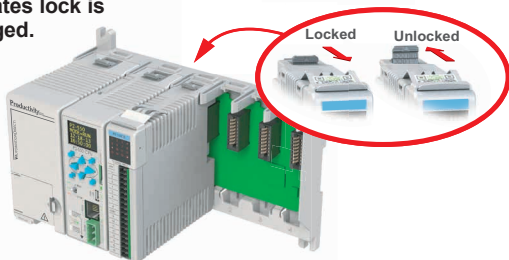

**Step Three:** Attach field wiring using the removable terminal block or ZIPLink wiring system.



# QR Code



Use any QR Code reader application to display the module's product insert.

**Caution:** If possible, remove field power prior to proceeding. If not, then **EXTREME** care **MUST** be taken to prevent damage to the module, or even personal injury due to a short circuit from the live terminal block.

## Important Hot-Swap Information

**The Productivity2000 PAC supports hot-swap!**

Individual modules can be taken offline, removed, and replaced while the rest of the PAC system continues controlling your process. Before attempting to use the hot-swap feature, be sure to read the hot-swap topic in the programming software's help file or our online documentation at [AutomationDirect.com](http://AutomationDirect.com) for details on how to plan your installation for use of this powerful feature.

# Wiring Options

## 1 ZIPLink Feed Through Modules and Cables<sup>1</sup>

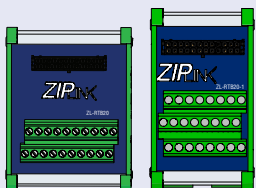

0.5 m (1.6 ft) cable  
1.0 m (3.3 ft) cable  
2.0 m (6.6 ft) cable



ZL-RTB20  
ZL-RTB20-1

ZL-P2-CBL18  
ZL-P2-CBL18-1  
ZL-P2-CBL18-2

## 2 Terminal Block with pigtail cable



1.0 m (3.3 ft) cable  
2.0 m (6.6 ft) cable

ZL-P2-CBL18-1P  
ZL-P2-CBL18-2P

## 3 Screw Terminal Block only



P2-RTB  
(Quantity 1)

## 4 Spring Clamp Terminal Block only

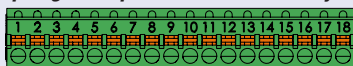

P2-RTB-1  
(Quantity 1)

## 5 Accessories<sup>2</sup>

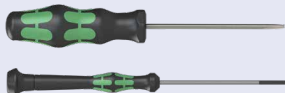

ZL-RTB-COM

TW-SD-SL-1

TW-SD-MSL-1

1. Cable + ZIPLink Module = Complete System

2. ZL-RTB-COM provides a common connection point for power or ground

# Module Configuration

Using the Hardware Configuration tool in the Productivity Suite programming software, drag and drop the P2-08ADL-2 module into the base configuration.

Select *Automatic Module Verification* or *No Verification and Enable Hot Swap*. If desired, assign a *User Tagname* to each input point (channel) selected and to each *Status Bit Item*.

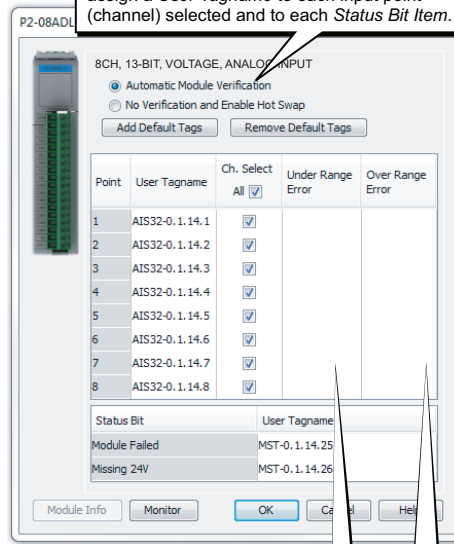

The "Under Range Error" bit for each channel activates for a signal around 0V ± offset error.

The "Over Range Error" bit for each channel activates for a signal around 10V ± gain error.

# Linear Scaling

The Scale (Linear) function can be used to:

- Convert analog field input signals from the range which is native to the analog input module to an application specific range.
- Make other linear conversions in ranges appropriate to the application.

Scale (Linear) (SCL)

Input: Level Transmitter      Output: Tank Level

In Min: 0      In Max: 8191  
Out Min: 220      Out Max: 12500

Select the Input and Output tags appropriate for the application. Convert raw input signals to engineering units for use in the program, or convert engineering units to output signals for control purposes

min      max

# Non-Linear Scaling

The Scale (Non-Linear) function can be used for Non-Linear applications.

Scale (Non-Linear) (SCLN)

Input: Level Transmitter      Output: Tank Level

Input value	Desired Output
0	0
1	0.5
2	1
3	1.55
4	2.25
5	3
6	4.55
6.5	6.75
7	7
0	0
0	0
0	0
0	0
0	0
0	0

Enter values for each breakpoint in the table. Each breakpoint will define a segment of the non-linear scaling.

min      max



## Diagnostic/Status

Under Range Error	1 bit per channel
Over Range Error	1 bit per channel
Module Failed	1 bit per module
Missing 24V	1 bit per module

Document Name	Edition/Revision	Date
P2-08ADL-2-DS	4th Ed.	12/12/2022

Copyright 2016, AutomationDirect.com Incorporated/All Rights Reserved Worldwide