

Output Specifications

Outputs per Module	16 sourcing
Voltage Rating	24VDC
Operating Voltage Range	21.6–26.4 VDC
Maximum Output Current	0.25 A continuous
On Voltage Drop	0.7 VDC
Maximum Inrush Current	Self-limited
OFF to ON Response	0.5 ms
ON to OFF Response	0.5 ms
Overcurrent Trip	0.6 A min., 1.2 A max. > 50ms duration*
Minimum Load Current to Avoid Open Load Fault Detection	113µA
Maximum Leakage Current	160µA @ 21.6–26.4 VDC
Overtemperature Shutdown	Independent to each output
Load Resistance to Avoid Open Load Fault Detection	<58kΩ
Status Indicators	Logic Side (16 points)
External 24V Error Indicator	Logic Side (1 point)
Fault Condition Indicator	Logic Side (16 points)
Commons	1
Fuses	None
External DC Power Required	24VDC @ 60mA

*Rev C1 and higher.

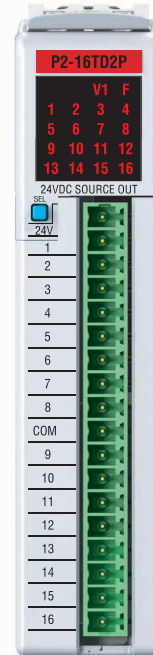

P2-16TD2P Sourcing Protected DC Output

The P2-16TD2P DC Output Module provides sixteen 24 VDC sourcing outputs with short-circuit and overload protection for use with the Productivity2000 System.

Output Specifications	1
Module Installation	2
Wiring Options	2
Wiring Diagram and Schematic.....	3
QR Code	3
Hot Swap Information.....	3
Warning	4
Removable Terminal Block	
Specifications	4
General Specifications	4
LED Status	4

Document Name	Edition/Revision	Date
P2-16TD2P-DS	5th Ed.	9/6/2019

Copyright 2016, AutomationDirect.com Incorporated/All Rights Reserved Worldwide

Terminal Block sold separately, (see wiring options on page 2).

Warranty: Thirty-day money-back guarantee. Two-year limited replacement. (See www.productivity2000.com for details).

Module Installation

WARNING: Do not apply field power until the following steps are completed. See hot-swapping procedure for exceptions.

Step One: Align module catch with base slot and rotate module into connector.

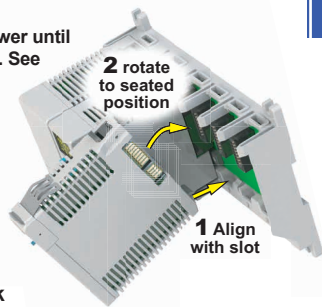

Step Two: Pull top locking tab toward module face. Click indicates lock is engaged.

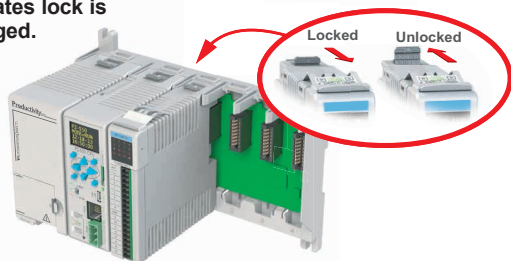

Step Three: Attach field wiring using the removable terminal block or ZIPLink wiring system.



Wiring Options

1 ZIPLink Feed Through Modules and Cables¹

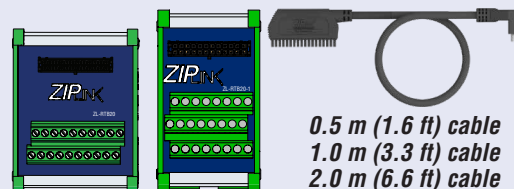

ZIPLINK
AUTOMATIONDIRECT

ZL-RTB20
ZL-RTB20-1

ZL-P2-CBL18
ZL-P2-CBL18-1
ZL-P2-CBL18-2

2 Terminal Block with pigtail cable



ZL-P2-CBL18-1P
ZL-P2-CBL18-2P

3 Screw Terminal Block only



P2-RTB
(Quantity 1)

4 Spring Clamp Terminal Block only

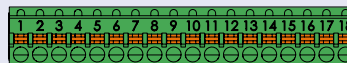

P2-RTB-1
(Quantity 1)

5 Accessories²

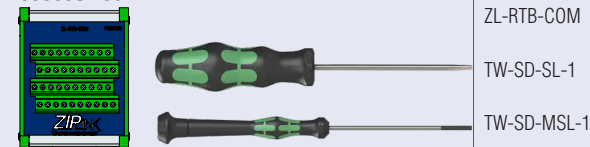

1. Cable + ZIPLink Module = Complete System

2. ZL-RTB-COM provides a common connection point for power or ground

Wiring Diagram and Schematic

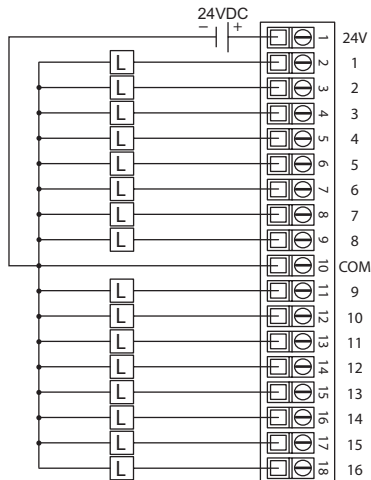
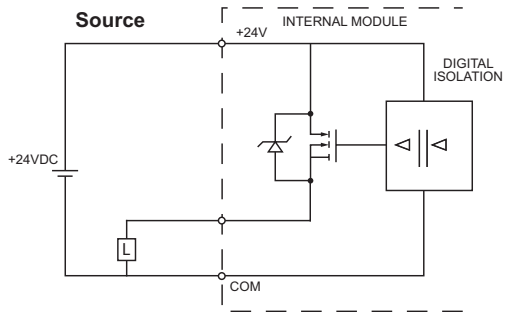

QR Code



Use any QR Code reader application to display the module's product insert.

Caution: If possible, remove field power prior to proceeding. If not, then **EXTREME** care **MUST** be taken to prevent damage to the module, or even personal injury due to a short circuit from the live terminal block.

Important Hot-Swap Information

The Productivity2000 supports hot-swap! Individual modules can be taken offline, removed, and replaced while the rest of the system continues controlling your process. Before attempting to use the hot-swap feature, be sure to read the hot-swap topic in the programming software's help file or our online documentation at AutomationDirect.com for details on how to plan your installation for use of this powerful feature.

WARNING: To minimize the risk of potential safety problems, you should follow all applicable local and national codes that regulate the installation and operation of your equipment. These codes vary from area to area and it is your responsibility to determine which codes should be followed, and to verify that the equipment, installation, and operation are in compliance with the latest revision of these codes.

Equipment damage or serious injury to personnel can result from the failure to follow all applicable codes and standards. We do not guarantee the products described in this publication are suitable for your particular application, nor do we assume any responsibility for your product design, installation, or operation.

If you have any questions concerning the installation or operation of this equipment, or if you need additional information, please call Technical Support at 770-844-4200.

This publication is based on information that was available at the time it was printed. At AutomationDirect.com® we constantly strive to improve our products and services, so we reserve the right to make changes to the products and/or publications at any time without notice and without any obligation. This publication may also discuss features that may not be available in certain revisions of the product.

Removable Terminal Block Specifications

Part Number	P2-RTB	P2-RTB-1
Number of Positions	18 Screw Terminals	18 Spring Clamp Terminals
Wire Range	30–16 AWG (0.051–1.31 mm ²) Solid / Stranded Conductor 3/64 in. (1.2 mm) Insulation Maximum 1/4 in. (6–7 mm) Strip Length	28–16 AWG (0.081–1.31 mm ²) Solid / Stranded Conductor 3/64 in. (1.2 mm) Insulation Maximum 19/64 in. (7–8 mm) Strip Length
Conductors	"USE COPPER CONDUCTORS, 75°C" or Equivalent.	
Screw Driver Width	0.1 inch (2.5 mm) Maximum*	
Screw Size	M2	N/A
Screw Torque	2.5 lb·in (0.28 N·m)	N/A

*Recommend Screw Driver TW-SD-MSL-1

General Specifications

Operating Temperature	0° to 60°C (32° to 140°F),
Storage Temperature	-20° to 70°C (-4° to 158°F)
Humidity	5 to 95% (non-condensing)
Environmental Air	No corrosive gases permitted
Vibration	IEC60068-2-6 (Test Fc)
Shock	IEC60068-2-27 (Test Ea)
Field to Logic Side Isolation	1800VAC applied for 1 second
Insulation Resistance	>10MΩ @ 500VDC
Heat Dissipation	2600mW
Enclosure Type	Open Equipment
Module Keying to Backplane	Electronic
Module Location	Any I/O slot in a Productivity2000 System.
Field Wiring	Use ZIP link Wiring System or removable terminal block (not included). See "Wiring Options" on page 2.
EU Directive	See the "EU Directive" topic in the Productivity Suite Help File. Information can also be obtained at: www.productivity2000.com
Connector Type (not included)	18 Position Removable Terminal Block
Weight	97g (3.4 oz)
Agency Approvals	UL 61010-1 and UL 61010-2-201 File E139594, Canada & USA CE (EN 61131-2 EMC, EN 61010-1 and EN 61010-2-201 Safety)*

*Meets EMC and Safety requirements. See the D.O.C. for details.

LED Status

Fault Condition	Fault Status Indication	Operation to Reset Fault
Missing External 24VDC	V1 LED is ON	Apply external 24 VDC
Open Load (Note 1)	F LED is ON (Note 2)	Connect the load
Over Temperature or Over Load Current		Turn the output OFF or cycle power

Note 1: Open Load Fault is always enabled, but is only valid when output is OFF. If Open Load Fault happens while output is ON, fault will not appear until you turn OFF output.

Note 2: The SEL button cycles between the output status and fault status. If the "F" LED is OFF the numbered LEDs are showing output status. If the "F" LED is ON the numbered LEDs are showing fault status of each output. The "V1" LED is independent of fault or output display.