

Input Specifications

Inputs per Module	32 (Sink/Source)
Rated Voltage	12–24 VDC
Operating Voltage	10.8–26.4 VDC
Input Current	2.5 mA @ 12VDC 5.0 mA @ 24VDC
Maximum Input Current @ Temp	6mA @ 60°C (26.4 VDC)
Input Impedance	4.7 kΩ @ 24VDC
ON Voltage Level*	≤ 4VDC sourcing ≥ 12.5 VDC sinking
OFF Voltage Level	> 6VDC sourcing < 8.5 VDC sinking
Minimum ON Current	2mA
Maximum OFF Current	1.5 mA
OFF to ON Response	2ms Maximum, 1ms Typical
ON to OFF Response	2ms Maximum, 1ms Typical
Status Indicators	Logic Side (32 Points)
Commons	4 Commons (8 Points/Common)
External DC Power Required*	24VDC (-20% / +25%) @ 150mA

Voltage Ratings

*External Supply Voltage	On Voltage Level
19.2 VDC	>9.0 VDC
24.0 VDC	>11.3 VDC
26.4 VDC	>12.5 VDC



P2-32ND3 DC Input

The P2-32ND3 DC Input Module provides 32 sinking/sourcing 12–24 VDC inputs for use with the Productivity2000 System.

Input Specifications	1
Module Installation Procedure	2
QR Code	2
Hot Swap Information	3
Wiring Options	3
Wiring Diagram and Schematic	3
Warning	4
Connector Specifications	4
General Specifications	4

Warranty: Thirty-day money-back guarantee. Two-year limited replacement.
 (See www.productivity2000.com for details).

Module Installation

WARNING: Do not apply field power until the following steps are completed. See hot-swapping procedure for exceptions.

Step One: Align module catch with base slot and rotate module into connector.

Step Two: Pull top locking tab toward module face. Click indicates lock is engaged.

Step Three: Attach field wiring using the removable terminal block or ZIPLink wiring system.

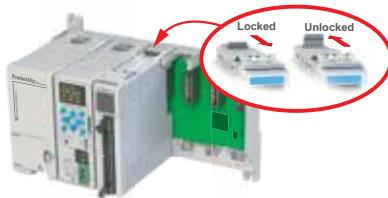
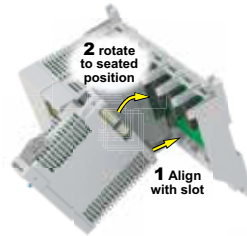

QR Code



Use any QR Code reader application to display the module's product insert.

Important Hot-Swap Information

The Productivity2000 supports hot-swap! Individual modules can be taken offline, removed, and replaced while the rest of the system continues controlling your process. Before attempting to use the hot-swap feature, be sure to read the hot-swap topic in the programming software's help file or our online documentation at AutomationDirect.com for details on how to plan your installation for use of this powerful feature.

Wiring Options

ZIPLink Connection System
Cable + ZIPLink Module = Complete System



ZIPLink pre-wired cables
ZIPLink Modules
 0.5 m (1.6 FT) cable
 1.0 m (3.3 FT) cable
 2.0 m (6.6 FT) cable



ZL-CBL-40
 ZL-CBL-40-1
 ZL-CBL-40-2

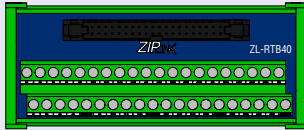

Feed through

Note: P2-32ND3 is UL/CUL listed when used with ZL-RTB40

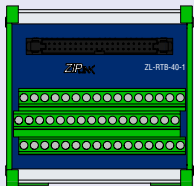

LED Sensor Input

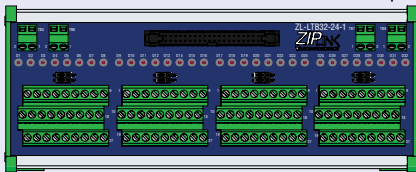

ZL-RTB40

ZL-RTB40-1

ZL-LTB32-24-1

Wiring Diagram and Schematic

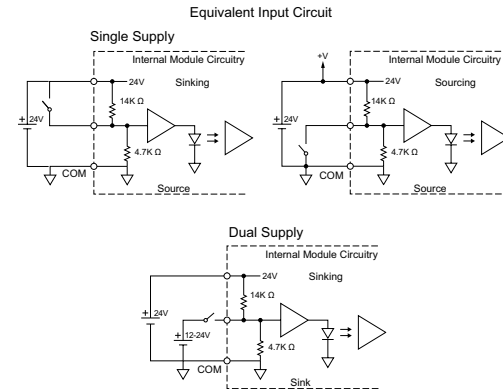
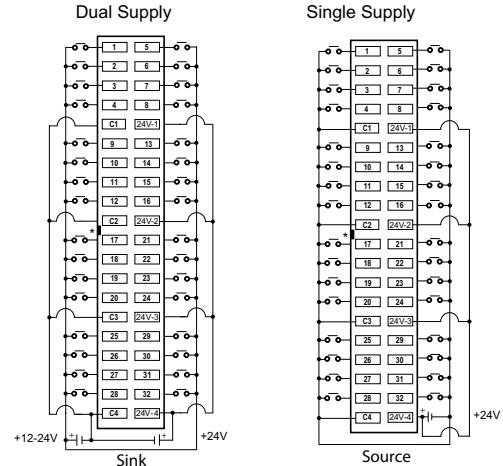

*Denotes key location of all associated ZIPLink cables.

WARNING: To minimize the risk of potential safety problems, you should follow all applicable local and national codes that regulate the installation and operation of your equipment. These codes vary from area to area and it is your responsibility to determine which codes should be followed, and to verify that the equipment, installation, and operation are in compliance with the latest revision of these codes.

Equipment damage or serious injury to personnel can result from the failure to follow all applicable codes and standards. We do not guarantee the products described in this publication are suitable for your particular application, nor do we assume any responsibility for your product design, installation, or operation.

If you have any questions concerning the installation or operation of this equipment, or if you need additional information, please call Technical Support at 770-844-4200.

This publication is based on information that was available at the time it was printed. At AutomationDirect.com® we constantly strive to improve our products and services, so we reserve the right to make changes to the products and/or publications at any time without notice and without any obligation. This publication may also discuss features that may not be available in certain revisions of the product.

General Specifications

Operating Temperature	0° to 60°C (32° to 140°F),
Storage Temperature	-20° to 70°C (-4° to 158°F)
Humidity	5 to 95% (non-condensing)
Environmental Air	No corrosive gases permitted
Vibration	IEC60068-2-6 (Test Fc)
Shock	IEC60068-2-27 (Test Ea)
Field to Logic Side Isolation	1800VAC applied for 1 second
Insulation Resistance	>10MΩ @ 500VDC
Heat Dissipation	6000mW
Enclosure Type	Open Equipment
Module Keying to Backplane	Electronic
Module Location	Any I/O slot in a Productivity2000 System.
Field Wiring	Use ZIP Link Wiring System only. See "Wiring Options" on page 3.
EU Directive	See the "EU Directive" topic in the Productivity Suite Help File. Information can also be obtained at: www.productivity2000.com
Weight	101g (3.56 oz)
Agency Approvals	UL61010-2-201 file E139594, Canada & USA CE (EMC: EN61131-2*, SAFETY: EN61010-2-201)

*Meets EMC and Safety requirements. See the D.O.C. for details.

Connector Specifications

Connector Type	IDC style Header with latch, Omron XG4A-4034
Number of Pins	40
Pitch	0.1 in (2.54 mm)

Document Name	Edition/Revision	Date
P2-32ND3-DS	2nd Ed.	9/26/2016

Copyright 2016, AutomationDirect.com Incorporated/All Rights Reserved Worldwide

Tech Support 770-844-4200

www.productivity2000.com