

Output Specifications

Outputs per Module		16 (sourcing)
Operating Voltage Range (Tolerance)	CE	6.25 – 24 VDC (-15% / + 20%)
	UL	6 – 27 VDC (-15% / + 10%)
Maximum Output Current @ Temp		0.5A / point, 4A / common @ 60°C
Minimum Output Current		0.4 mA
Maximum Leakage Current		0.3 mA @ 30 VDC
On Voltage Drop		0.2 VDC @ 0.5A
Maximum Inrush Current		2A for 10 ms
OFF to ON Response		≤ 1 ms
ON to OFF Response		≤ 2 ms
Terminal Type (not included)		20 position removable terminal block
Status Indicators		Logic Side (16 points)
Commons		2 Isolated (8 points / common)

WARNING: Explosion hazard – Substitution of components may impair suitability for Class I, Division 2.

AVERTISSEMENT: Risque d'explosion : la substitution de composants peut compromettre la convenance pour la Classe I, Zone 2 ou pour la Classe I, Division 2.

Warranty: Thirty-day money-back guarantee. Two-year limited replacement. (See www.automationdirect.com/P3000 for details).

Document Name	Edition/Revision	Date
P3-16TD2-M	1st Ed. Rev. D	03/03/2020

Copyright 2017, AutomationDirect.com Incorporated/All Rights Reserved Worldwide

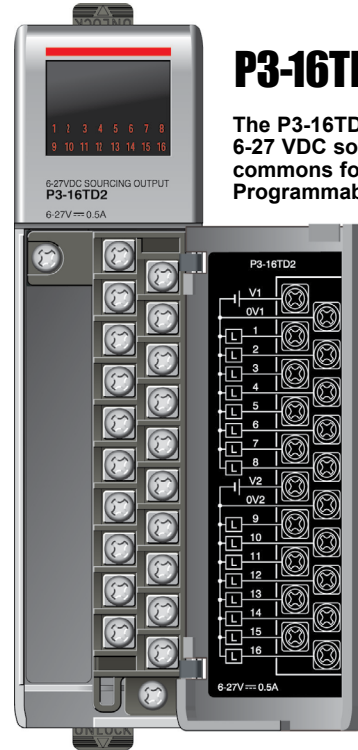

P3-16TD2 Sourcing Output

The P3-16TD2 DC Output Module provides 16 6-27 VDC sourcing outputs with 2 isolated commons for use with the Productivity3000 Programmable Automation Controller.

- Input Specifications 1
- Module Installation Procedure 2
- Terminal Block Removal 2
- Hot Swap Information 2
- Wiring Options 3
- Schematic and Wiring Diagram 3
- Safety Information 4
- Removable Terminal Block Specifications 4
- General Specifications 4

Terminal Block sold separately, Terminal Block Cover included (see wiring options on page 3).

Module Installation Procedure

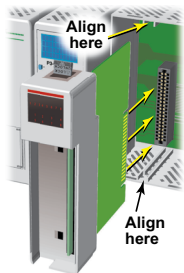

WARNING: Do not apply field power until the following steps are completed. See hot-swapping procedure for exceptions.

AVERTISSEMENT: Ne pas appliquer la puissance de champ avant l'exécution des étapes qui suivent. Consultez la procédure de remplacement à chaud pour les exceptions.

Step One: Align circuit card with slot and press firmly to seat module into connector.

Step Two: Pull top and bottom locking tabs toward module face. Click indicates lock is engaged.

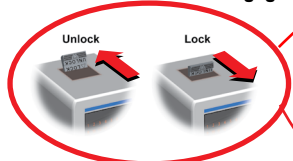

Step Three: Attach field wiring using optional terminal block or ZIPLink wiring system and install cover.

To install or remove terminal block cover, press middle to flex cover.

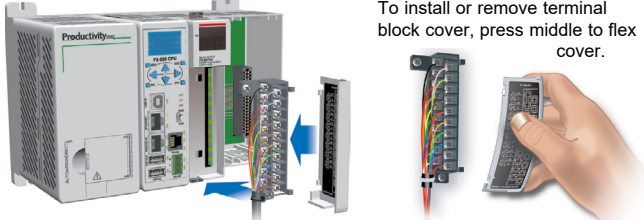

WARNING: Explosion hazard – Do not connect or disconnect connectors or operate switches while circuit is live unless the area is known to be non-hazardous. Do not hot-swap modules unless the area is known to be non-hazardous.

AVERTISSEMENT: Risque d'explosion : ne pas connecter ou déconnecter les connecteurs ni actionner les commutateurs alors que le circuit est sous tension, à moins que la zone ne soit reconnue non dangereuse. Ne pas remplacer à chaud les modules à moins que la zone ne soit reconnue non dangereuse.



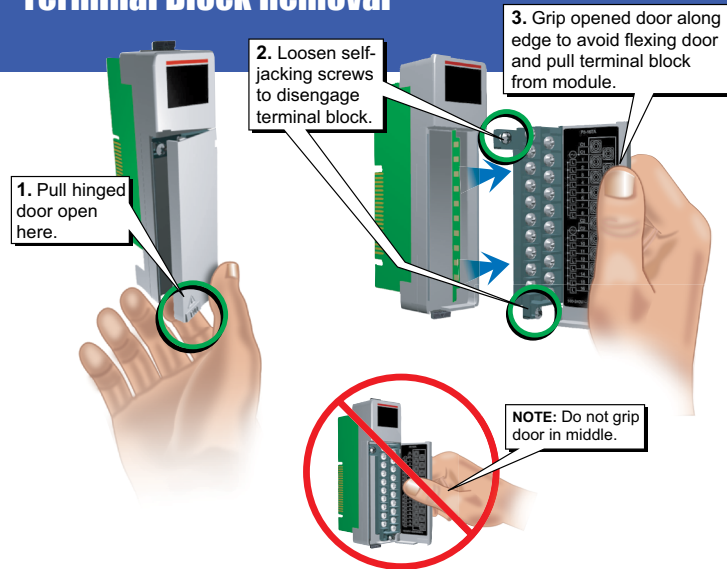



Terminal Block Removal

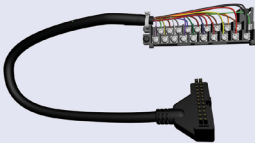

Important Hot-Swap Information

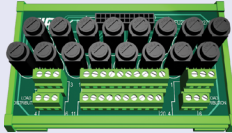
The Productivity3000 PAC supports hot-swap! Individual modules, expansion bases, and entire remote base groups can be taken offline, removed, and replaced while the rest of the PAC system continues controlling your process. Before attempting to use the hot-swap feature, be sure to read the hot-swap topic in the programming software's help file or our online documentation at AutomationDirect.com for details on how to plan your installation for use of this powerful feature.

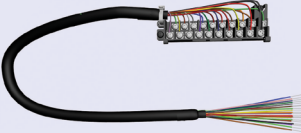
Wiring Options

<p>1 ZIPLink Connection System Cable + ZIPLink Module = Complete System</p> <p>ZIPLink pre-wired terminal block cables</p>  <p>0.5m (1.6FT) cable 1.0m (3.3FT) cable 2.0m (6.6FT) cable</p> <p>ZIPLink Modules</p> <p>Feedthrough</p>  <p>Remote Fuse</p> 	 <p>ZL-P3-CBL20 ZL-P3-CBL20-1 ZL-P3-CBL20-2</p> <p>ZL-RTB20</p> <p>ZL-RFU20</p>
<p>2 Terminal Block with pigtail cable</p>  <p>0.5m (1.6FT) cable 1.0m (3.3FT) cable 2.0m (6.6FT) cable</p>	 <p>ZL-P3-CBL20-P ZL-P3-CBL20-1P ZL-P3-CBL20-2P</p>
<p>3 Terminal Block only</p> 	<p>P3-RTB (Quantity 1)</p>

Schematic and Wiring Diagrams

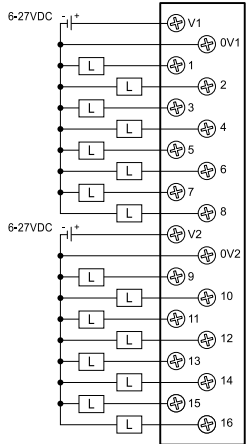
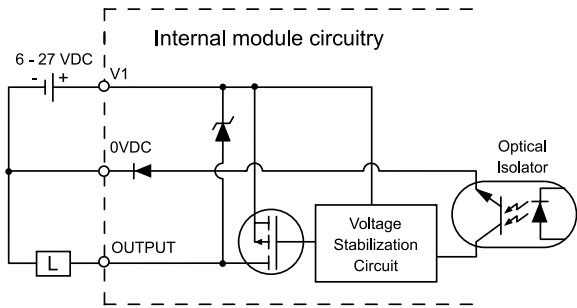

To minimize the risk of potential safety problems, you should follow all applicable local and national codes that regulate the installation and operation of your equipment. These codes vary from area to area and it is your responsibility to determine which codes should be followed, and to verify that the equipment, installation, and operation are in compliance with the latest revision of these codes.

Equipment damage or serious injury to personnel can result from the failure to follow all applicable codes and standards. We do not guarantee the products described in this publication are suitable for your particular application, nor do we assume any responsibility for your product design, installation, or operation.

If you have any questions concerning the installation or operation of this equipment, or if you need additional information, please call Technical Support at 770-844-4200.

This publication is based on information that was available at the time it was printed. At AutomationDirect.com® we constantly strive to improve our products and services, so we reserve the right to make changes to the products and/or publications at any time without notice and without any obligation. This publication may also discuss features that may not be available in certain revisions of the product.

Removable Terminal Block Specifications

Number of Positions	20 Screw Terminals
Wire Range	22-14 AWG (0.324 to 2.08 sq. mm) Solid / Stranded Conductor 3/64 in. (1.2 mm) insulation maximum "USE COPPER CONDUCTORS , 60°C" or equivalent.
Screw Driver Width	1/4 inch (6.5 mm) maximum
Screw Size	M3 size
Screw Torque	Field Terminals – 7- 9 in./lb (.0882 - 1.02 Nm) Self-jacking Screws – 2.7 - 3.6 in./lb (0.3 - 0.4 Nm). Do not overtighten screws when installing terminal block.

General Specifications

Operating Temperature	0° to 60°C (32° to 140°F),
Storage Temperature	-20° to 70°C (-4° to 158°F)
Humidity	5 to 95% (non-condensing)
Environmental Air	No corrosive gases permitted
Vibration	IEC60068-2-6 (Test Fc)
Shock	IEC60068-2-27 (Test Ea)
Field to Logic Side Isolation	1500VAC applied for 1 minute
Insulation Resistance	>10MΩ @ 500 VDC
Heat Dissipation	5.38W
Enclosure Type	Open Equipment
Agency Approvals	UL508 file E157382, Canada & USA UL1604 file E200031, Canada & USA CE (EN61131-2*) This equipment is suitable for use in Class 1, Division 2, Groups A, B, C and D or non-hazardous locations only.
Module Keying to Backplane	Electronic
Module Location	Any I/O slot in any local, expansion, or remote base in a Productivity3000 System.
Field Wiring	Removable Terminal Block (not included). Use ZIPLink Wiring System or optional terminal block. See "Wiring Options" on page 3.
Weight	120g (4.23 oz)

*Meets EMC and Safety requirements. See the D.O.C. for details.