

Input Specifications

Inputs per Module		64 (sinking / sourcing)
Operating Voltage Range (Tolerance)	CE	24 VDC (± 10%)
	UL	24 VDC (± 10%)
Peak Voltage		26.4 VDC
Input Current (Typical)		2.7 mA @ 24 VDC
Maximum Input Current @ Temp		3.5 mA @ 60° C (26.4 VDC)
Input Impedance		8.2k Ω @ 24 VDC
ON Voltage Level		> 18 VDC
OFF Voltage Level		< 8 VDC
Minimum ON Current		2 mA
Maximum OFF Current		1.1 mA
OFF to ON Response		Max. 2 ms Typical 1ms
ON to OFF Response		Max. 2 ms Typical 1ms
Status Indicators		Logic Side (32 points x 2)
Connector Type		Two 40-pin IDC
Commons		8 Isolated (8 points / common)

WARNING: Explosion hazard – Substitution of components may impair suitability for Class I, Division 2.

AVERTISSEMENT: Risque d'explosion : la substitution de composants peut compromettre la convenance pour la Classe I, Zone 2 ou pour la Classe I, Division 2.

Document Name	Edition/Revision	Date
P3-64ND3-M	1st Ed. Rev E	03/06/2020

Copyright 2017, AutomationDirect.com Incorporated/All Rights Reserved Worldwide

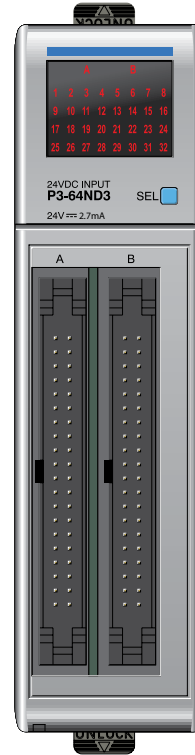

P3-64ND3 Sinking/ Sourcing Input

The P3-64ND3 DC Input Module provides 64 24 VDC sinking or sourcing inputs with 8 isolated commons for use with the Productivity3000 Programmable Automation Controller.

Input Specifications	1
Module Installation Procedure	2
Wiring Options	2
Schematic and Wiring Diagrams	3
Hot Swap Information	3
Safety Information	4
Connector Specifications	4
General Specifications	4

Warranty: Thirty-day money-back guarantee. Two-year limited replacement. (See www.automationdirect.com/P3000 for details).

Module Installation Procedure

WARNING: Do not apply field power until the following steps are completed. See hot-swapping procedure for exceptions.
AVERTISSEMENT: Ne pas appliquer la puissance de champ avant l'exécution des étapes qui suivent. Consultez la procédure de remplacement à chaud pour les exceptions.

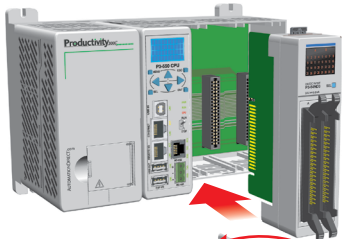

Step One:
 Align circuit card with slot and press firmly to seat module into connector.

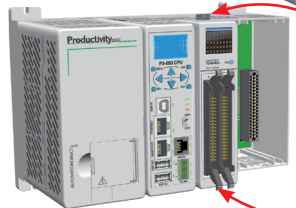

Step Two
 Pull top and bottom locking tabs toward module face. Click indicates lock is engaged.

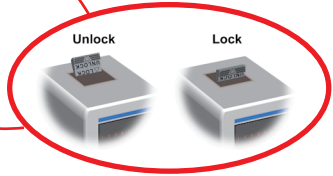

Step Three
 Attach field wiring using the ZIPLink wiring system.

WARNING: Explosion hazard – Do not connect or disconnect connectors or operate switches while circuit is live unless the area is known to be non-hazardous. Do not hot-swap modules unless the area is known to be non-hazardous.
AVERTISSEMENT: Risque d'explosion : ne pas connecter ou déconnecter les connecteurs ni actionner les commutateurs alors que le circuit est sous tension, à moins que la zone ne soit reconnue non dangereuse. Ne pas remplacer à chaud les modules à moins que la zone ne soit reconnue non dangereuse.

Wiring Options

ZIPLink Connection System
Cable + ZIPLink Module = Complete System

NOTE: The P3-64ND3 module requires 2 ZIPLink modules and 2 ZIPLink cables.



ZIPLink pre-wired cables

- 0.5m (1.6FT) cable ZL-CBL40
- 1.0m (3.3FT) cable ZL-CBL40-1
- 2.0m (6.6FT) cable ZL-CBL40-2

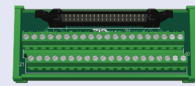

ZIPLink Modules

Feed through ZL-RTB40



LED Sensor Input ZL-LTB32-24

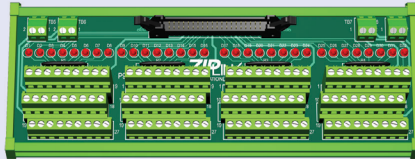

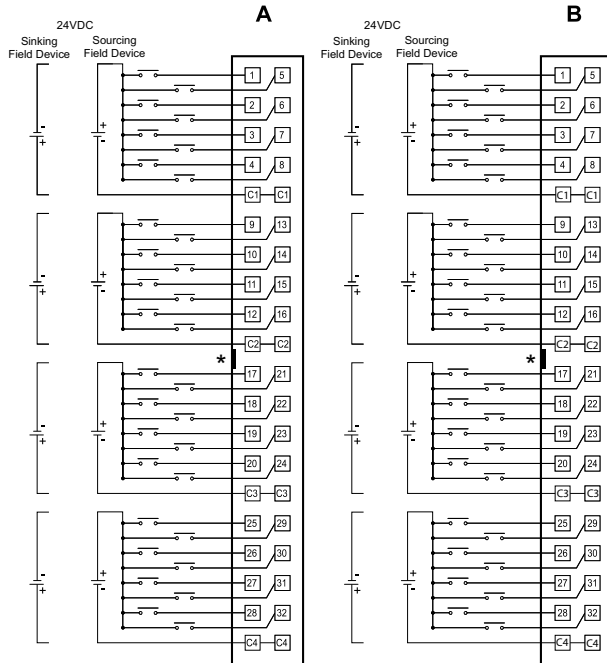

*Denotes key location of all associated ZIPLink cables

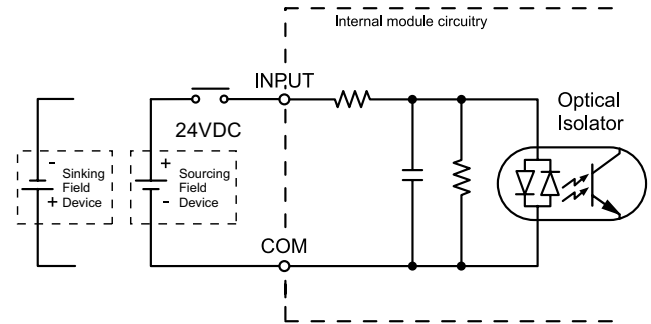

Important Hot-Swap Information

The Productivity3000 PAC supports hot-swap! Individual modules, expansion bases, and entire remote base groups can be taken offline, removed, and replaced while the rest of the PAC system continues controlling your process. Before attempting to use the hot-swap feature, be sure to read the hot-swap topic in the programming software's help file or our online documentation at AutomationDirect.com for details on how to plan your installation for use of this powerful feature.

To minimize the risk of potential safety problems, you should follow all applicable local and national codes that regulate the installation and operation of your equipment. These codes vary from area to area and it is your responsibility to determine which codes should be followed, and to verify that the equipment, installation, and operation are in compliance with the latest revision of these codes.

Equipment damage or serious injury to personnel can result from the failure to follow all applicable codes and standards. We do not guarantee the products described in this publication are suitable for your particular application, nor do we assume any responsibility for your product design, installation, or operation.

If you have any questions concerning the installation or operation of this equipment, or if you need additional information, please call Technical Support at 770-844-4200.

This publication is based on information that was available at the time it was printed. At AutomationDirect.com® we constantly strive to improve our products and services, so we reserve the right to make changes to the products and/or publications at any time without notice and without any obligation. This publication may also discuss features that may not be available in certain revisions of the product.

Connector Specifications

Connector Type	IDC style header with latch, Omron XG4A-4034
Number of Pins	40 point x 2
Pitch	0.1 in. (2.54 mm)

General Specifications

Operating Temperature	0° to 60°C (32° to 140°F),
Storage Temperature	-20° to 70°C (-4° to 158°F)
Humidity	5 to 95% (non-condensing)
Environmental Air	No corrosive gases permitted
Vibration	IEC60068-2-6 (Test Fc)
Shock	IEC60068-2-27 (Test Ea)
Field to Logic Side Isolation	1500VAC applied for 1 minute
Insulation Resistance	>10MΩ @ 500 VDC
Heat Dissipation	6.91W
Enclosure Type	Open Equipment
Agency Approvals	UL508 file E157382, Canada & USA UL1604 file E200031, Canada & USA CE (EN61131-2*) This equipment is suitable for use in Class 1, Division 2, Groups A, B, C and D or non-hazardous locations only.
Module Keying to Backplane	Electronic
Module Location	Any I/O slot in any local, expansion, or remote base in a Productivity3000 System.
Field Wiring	Use ZIPLink Wiring System. See "Wiring Options" on page 2.
Weight	170g (6.00 oz)

*Meets EMC and Safety requirements. See the D.O.C. for details.