

Remote Slave Specifications (P3-550 Only)

Mounting Location	Controller slot in remote base
Communications - 4 Integrated Ports	REMOTE I/O: (10/100Mbps Ethernet) 1 P3-550 EXP I/O OUT: (2.0, Type A, Proprietary) 4 P3-EX Local Expansion Bases RS-232: (RJ12, 1200-115.2k Baud) ASCII (half & full duplex), Modbus RS-485: (Removable Terminal Included, 1200-115.2k Baud) ASCII, Modbus
Max. Number of Ethernet Remote I/O Bases	16
Max. Number of Expansion I/O Bases	68 (4 per CPU, 4 per Remote Base)
Max. Number of I/O per CPU System	59,840 (CPU Base with 4 Expansion Bases plus 16 Remote Bases with 4 Expansion Bases per Remote, with 11 64-point I/O modules per base)

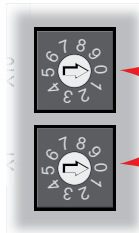

See Important Information on page 3 before installation.



Document Name	Edition/Revision	Date
P3-RX-M	1st Ed.Revision E	12/01/2017

Copyright 2017, AutomationDirect.com Incorporated/All Rights Reserved Worldwide

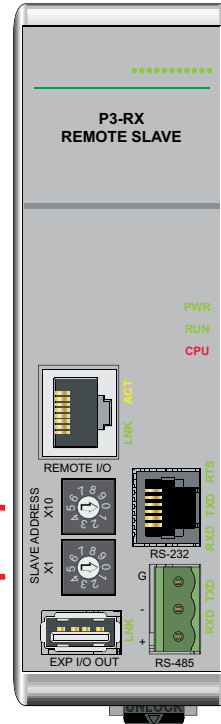

P3-RX Remote Slave

The P3-RX is a high-performance, Remote Slave module for use with the Productivity3000 Programmable Automation Controller. (P3-550 Only)

Remote Slave Specifications	1
Front Panel	2
Installation Procedure	2
Addressing Procedure	3
Remote I/O Port Specifications	4
Exp I/O Out Port Specifications	4
RS-232 Port Specifications	5
RS-485 Port Specifications	6
Product Comparison	6
Terminal Block Specification	6
Typical Remote I/O Configuration	7
Safety Information	8
Status Indicators	8
General Specifications	8
Hot Swap Information	8

Warranty: Thirty-day money-back guarantee. Two-year limited replacement. (See www.automationdirect.com/P3000 for details).

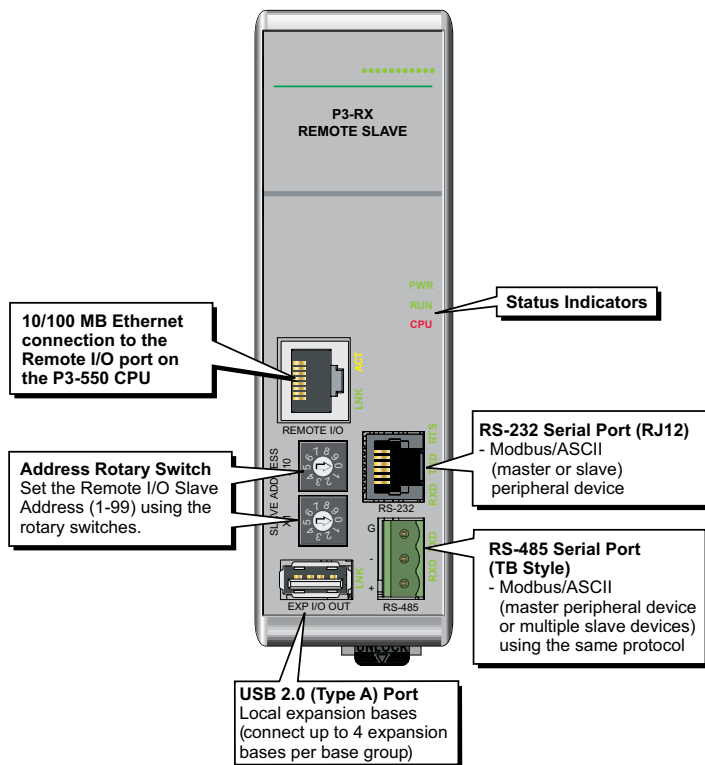

Step One:

Locate the two sockets next to the power supply; the P3-RX will be inserted into this location.

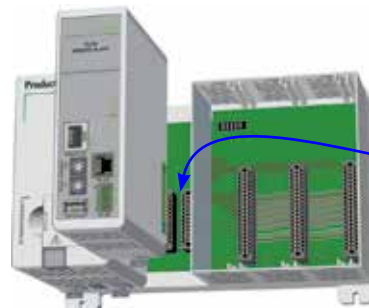

Step Two:

Insert P3-RX at a 45° angle into the notch located at the top of the base and rotate down until seated.



Step Three:

Snap retaining tab into the locked position.

WARNING: Explosion hazard – Do not connect or disconnect connectors or operate switches while circuit is live unless the area is known to be non-hazardous. Do not hot swap.

AVERTISSEMENT: Risque d'explosion: ne pas connecter ou déconnecter les connecteurs ni actionner les commutateurs alors que le circuit est sous tension, à moins que la zone ne soit reconnue non dangereuse. Ne pas remplacer à chaud.



Addressing Procedure

Setting the Remote Slave Address

Each Remote Slave (up to 32 total) must have a unique address between 1 and 99. The address is set using the two rotary switches located on the face of the module, X10 for setting the tens units and X1 for setting the ones unit.

For example, to set a remote slave address to 21, turn the X10 arrow until it points at number 2 and the X1 arrow until it points at number 1.

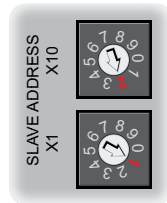

IMPORTANT:

- The factory setting of 00 is not a valid address.
- Address selection must be set prior to power-up.
- Slave addresses are only read on power-up.
- If there are duplicate P3-RX slave addresses on the same network, a critical error will be displayed on the CPU.

It is also necessary to configure the remote addresses using the Productivity Suite Programming Software. If connected online to a Productivity3000 system with slave installed, go to *Hardware Configuration* and select the *Read Configuration (1)* button. The CPU will automatically read the addresses of the remote slaves and add them to the configuration.

If setting up offline, go to *Hardware Configuration*, select *PAC Base Groups (2)*, and then select *Remote Base Group (3)*. In the *Add Remote Base Group (4)* window, select the same Remote Base Number as set on the rotary switches.

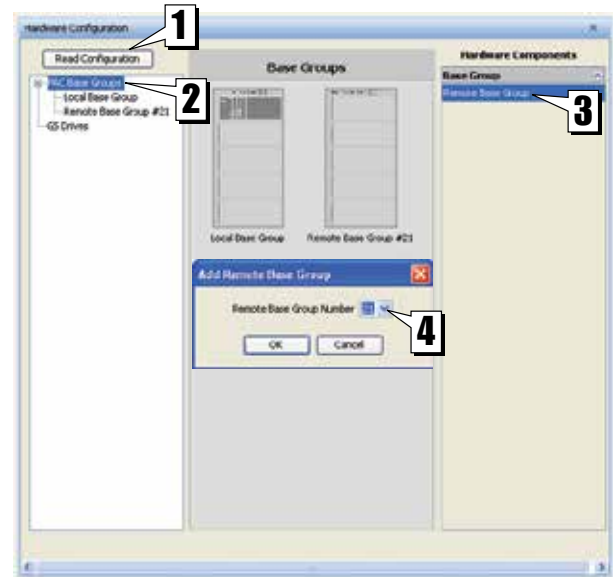

Remote I/O Port Specifications

Description	Proprietary transformer isolated Ethernet Port with built-in surge protection for connection to CPU Remote I/O Master port.
Transfer Rate	10/100 Mbps
Port Status LEDs	Green LED is illuminated when network LINK is established. Yellow LED backlit when port is active (ACT).
Cables	Use a Patch (straight through) cable when a switch or hub is used. Use a Crossover cable when a switch or hub is not used.

EXP I/O OUT Specifications

Description	Proprietary USB 2.0 (Type A) Master output for connection for up to four P3-EX local expansion bases, with built-in surge protection.
Transfer Rate	480 Mbps
Port Status LED	Green LED is illuminated when LINK is established to connected device
Cables	USB Type A to USB Type B. The P3-EX Expansion Module includes a 6 foot USB cable, part number P3-EX-CBL6.

Crossover Cable

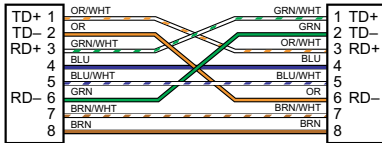

RJ45

RJ45

Patch (Straight-through) Cable

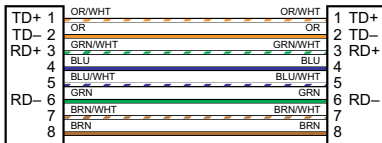

RJ45

RJ45

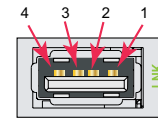
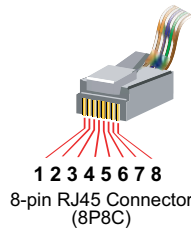
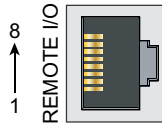

Mating face of USB type A female

Pin #	Signal
1	Reset
2	- Data
3	+ Data
4	GND

RS-232 Specifications

Description	Non-isolated RS-232 DTE port connects the P3-RX as a Modbus or ASCII master or slave to a peripheral device. Includes ESD and built-in surge protection.
Data Rates	Selectable, 1200, 2400, 9600, 19200, 33600, 38400, 57600, and 115200.
+5V Cable Power Source	210mA maximum at 5V, +/- 5%. Limited by self-resetting current limiting device. Reverse polarity protected.
TXD	RS-232 Transmit output
RXD	RS-232 Receive input
RTS	Handshaking output for flow control.
GND	Logic ground
Maximum Output Load (TXD/RTS)	3K Ω , 1,000pf
Minimum Output Voltage Swing	+/-5V
Output Short Circuit Protection	+/-15mA
Port Status LED	Green LED is illuminated when active for TXD, RXD and RTS



6-pin RJ12 Female Modular Connector

Pin #	Signal
1	GND Logic Ground
2	+5V 210 mA Maximum
3	RXD RS-232 Input
4	TXD RS-232 Output
5	RTS RS-232 Output
6	GND Logic Ground

RS-485 Specifications

Description	Non-isolated RS-485 port connects the P3-RX as a Modbus or ASCII master or slave to a peripheral device. Includes ESD/EFT protection and automatic echo cancellation when transmitter is active.
Data Rates	Selectable, 1200, 2400, 9600, 19200, 33600, 38400, 57600, and 115200.
TXD+/RXD+	RS-485 transceiver high
TXD-/RXD-	RS-485 transceiver low
GND	Logic ground
Input Impedance	19 k Ω
Maximum load	50 transceivers, 19k Ω each, 60 Ω termination
Output Short Circuit Protection	+/- 250mA, thermal shut-down protection
Electrostatic Discharge Protection	+/-8KV per IEC1000-4-2
Electrical Fast Transient Protection	+/-2KV per IEC1000-4-4.
Minimum Differential Output Voltage	1.5V with 60 Ω load
Fail safe inputs	Logic high input state if inputs are unconnected
Maximum Common Mode Voltage	-7.5V to 12.5V.
Port Status LED	Green LED is illuminated when active for TXD and RXD
Cable Options	L19827-100, L19827-500, L19827-1000 or Belden 9841 equivalent

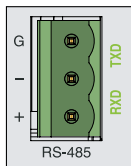
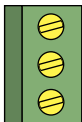

Pin #	Signal
G	GND
-	TXD-/RXD-
+	TXD+/RXD+

Removable connector included.
Spare connectors available
(part no. P3-RS485CON).

Product Comparison

	P3-RS	P3-RX
LCD Display		
USB Prog/Mon Port		
Remote Port (in)		
USB Local Expansion Port		
RS232 RJ12 Port		
RS485 Port		

Terminal Block Specifications

Number of Positions	3
Pitch	5 MM
Wire Range	28-12AWG Solid Conductor 30-12AWG Stranded Conductor
Screw Driver Width	1/8 inch (3.175mm) maximum
Screw Size	M2.5
Screw Torque	4.5 Lb-in

Typical Remote I/O Configuration

Add up to 16 Remote Base Groups using P3-RX Remote Slave modules and up to 32 GS Drives on the Remote I/O Ethernet Network. (P3-550 Only)

Add up to 4 bases to each group using P3-EX expansion modules with USB connections.

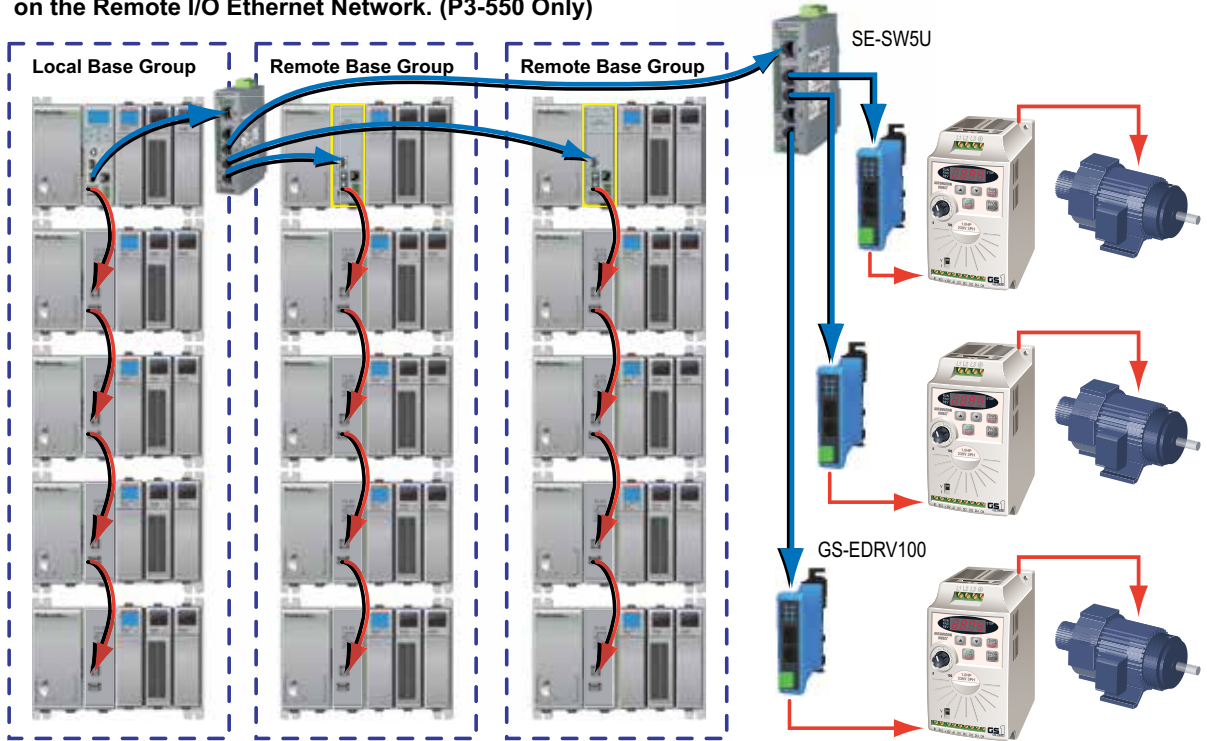

To minimize the risk of potential safety problems, you should follow all applicable local and national codes that regulate the installation and operation of your equipment. These codes vary from area to area and it is your responsibility to determine which codes should be followed, and to verify that the equipment, installation, and operation are in compliance with the latest revision of these codes.

Equipment damage or serious injury to personnel can result from the failure to follow all applicable codes and standards. We do not guarantee the products described in this publication are suitable for your particular application, nor do we assume any responsibility for your product design, installation, or operation.

If you have any questions concerning the installation or operation of this equipment, or if you need additional information, please call Technical Support at 770-844-4200.

This publication is based on information that was available at the time it was printed. At AutomationDirect.com® we constantly strive to improve our products and services, so we reserve the right to make changes to the products and/or publications at any time without notice and without any obligation. This publication may also discuss features that may not be available in certain revisions of the product.

General Specifications

Operating Temperature	0° to 60°C (32° to 140°F)
Storage Temperature	-20° to 70°C (-4° to 158°F)
Humidity	5 to 95% (non-condensing)
Environmental Air	No corrosive gases permitted
Vibration	IEC60068-2-6 (Test Fc)
Shock	IEC60068-2-27 (Test Ea)
Heat Dissipation	4W
Enclosure Type	Open Equipment
Agency Approvals	UL508 file E157382, Canada & USA UL1604 file E200031, Canada & USA CE (EN61131-2*) This equipment is suitable for use in Class 1, Division 2, Groups A, B, C and D or non-hazardous locations only.
Module Location	Controller slot in a remote base in a Productivity3000 System
EU Directive	See the "EU Directive" topic in the Productivity3000 Help File. Information can also be obtained at: www.automationdirect.com/P3000
Weight	260g (9 oz)

*Meets EMC and Safety requirements. See the D.O.C. for details.

RX Status Indicators

PWR	Green LED is backlit when power is on
RUN	Green LED is backlit to indicate when CPU has valid project file with RS configured.
CPU	Red LED is backlit during power on reset, power down, or watch-dog time-out.

PWR

RUN

CPU



Hot-Swapping Information

Note: This device cannot be Hot Swapped.

WARNING: Explosion hazard – Substitution of components may impair suitability for Class I, Division 2.

AVERTISSEMENT: Risque d'explosion : la substitution de composants peut compromettre la convenance pour la Classe I, Zone 2 ou pour la Classe I, Division 2.