

Panel Interface Connector Panel Cutout for Size 10 Housing

- Recommended mounting screw size: #8 or M4 screw. For typical 14 gauge steel enclosure, use #8 - 32 x 3/4" screw
- Recommended torque: 1.2 Nm (10.62 Lb-in)
- Product ships with gasket
- NEMA / UL Type rating (with gasket): 12, 4, and 4x.
- IP 65
- UL file E495019
- RoHS compliant
- Made in USA

Housing Dimensions

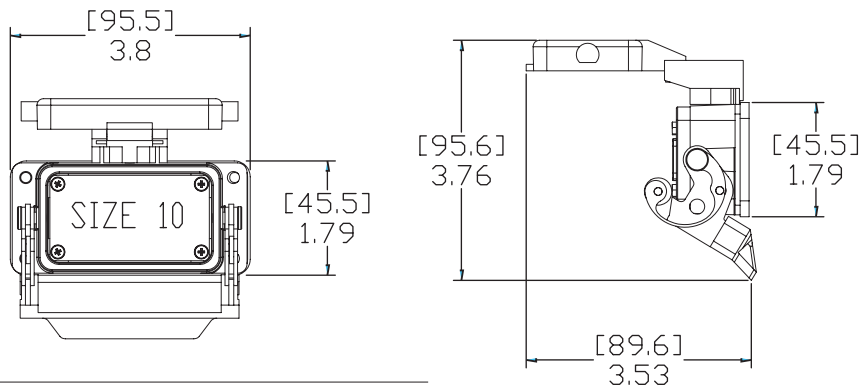

IMPORTANT: WHEN PRINTING THIS TEMPLATE, MAKE SURE YOUR PRINTER PAGE SCALING IS SET TO "NONE". (OTHER PRINT SETTINGS, SUCH AS "FIT TO PRINTABLE AREA", MAY ALTER THE TEMPLATE DIMENSIONS.) ALSO, MEASURE THE DIMENSIONS ON THE PRINTOUT TO VERIFY THAT THEY ARE CORRECT.

Note: All dimensions stated in inches [millimeters]

Panel Cutout Template

