

DL405 CPU Specifications

DL405 CPU Specifications	
D4-454	
System Capacity	
Total memory available (words)	46.8K
Ladder memory (words)	
built-in memory	31.5K
with memory cartridge	N/A
V-memory (words)	15.3K
Battery backup	Yes, MRAM*
Total CPU memory I/O pts. available	8192 (X+Y+GX+GY)
(actual I/O points depend on I/O configuration selected)	2/4/8/16/32/64
I/O module point density	4/6/8
I/O module slots per base	1024 in/1024 out
Local/local expansion	4224 max.
Serial Remote I/O (including local & exp. I/O)	3
Remote I/O Channels	512, 2048
I/O pts. per remote module	Yes, 8192 max.
Ethernet Remote I/O (including local/exp. I/O)	(Including local and exp. I/O)
discrete I/O pts.	Map into V-memory Limited by power budget 16,384 (16 fully expanded)
Analog I/O channels	H4-EBC Servers using
Remote I/O channels	V-memory and bit-of-word instructions)
I/O per remote channel	
Performance	
Contact execution (boolean)	0.96 μ s
Typical scan (1K boolean)	4–5 ms
Programming and Diagnostics	
RLL ladder style	Yes
RLL PLUS/flowchart style (Stages)	Yes/1024
Run time editing	Yes
Supports Overrides	Yes
Variable/fixed scan	Fixed or variable
Instructions	210
Control relays	2048
Timers	256
Counters	256
Immediate I/O	Yes
Subroutines	Yes
For/next loops	Yes
Timed interrupt	Yes
Integer math	Yes
Floating-point math	Yes
Trigonometric functions	Yes
Table instructions	Yes
PID	Yes
Drum sequencers	Yes
Bit of word	Yes
Real-time clock/calendar	Yes
Internal diagnostics	Yes
Password security	Multi-level
System and User error log	Yes
IBox instructions	Yes
CPU Ports Communications	
Built-in ports	4 ports
K-sequence (proprietary protocol)	Yes
DirectNET	Yes
Modbus Client/Server	Yes
ASCII out (Print)	Yes
Maximum baud rate	38.4K
*Battery used for Real Time Clock backup	

D4-454 Key Features

D4-454 CPU

D4-454 \$1,071.00

D4-454DC-1 \$1,232.00



D4-454 CPU*

The D4-454 CPUs provides tremendous capability using updated microprocessor technology allowing the D4-454 to be the CPU of choice for the DL405 family.

Built-in CPU Communications Ports

The D4-454 offers four built-in ports for extra convenience. The 15-pin port offers our proprietary K-sequence protocol and is primarily used for programming connections to a PC running DirectSOFT6 programming software (version 6.1 or later) or to a [D4-HPP-1](#) handheld programmer. It can also be used to connect to a **C-more** panel or other operator interfaces. The 6-pin phone jack supports K-sequence; DirectNET Client/Server, ASCII output and Modbus RTU Client/Server protocols. The bottom 25-pin port contains two logical ports with different pins for each port. It is primarily a networking port that supports DirectNET Client/Server or Modbus Client/Server protocols. The bottom port can be used as an ASCII output port for connections to devices that can accept ASCII input. It can also be used as a remote I/O Client. The Communications Ports table on the next page has a complete description of each port.

* The D4-454 CPU is a direct replacement for the retired D4-450 CPU.

16 PID Loops

The D4-454 CPU can process up to 16 PID loops directly in the CPU. You can select from various control modes including automatic control, manual control, and cascade control. There are a wide variety of alarms including Process Variable, Rate of Change, and Deviation. The various loop operation parameters are stored in V-memory, which allows easy access from operator interfaces. Setup is accomplished with our DirectSOFT6 Programming Software. An overview of the various loop specifications and features is on page tDL4-7.

Floating-point Math

The D4-454 CPU supports IEEE format floating-point math calculations. This feature means the D4-454 includes full trigonometric functions and various forms of integer/floating point number conversions.

Power Supplies

We offer a choice of two built-in power supplies for the D4-454 CPUs. Available choices are an AC source or DC source:

- 110/220 VAC version - [D4-454](#)
- 24VDC version - [D4-454DC-1](#)

D4-454 offers four built-in communication ports

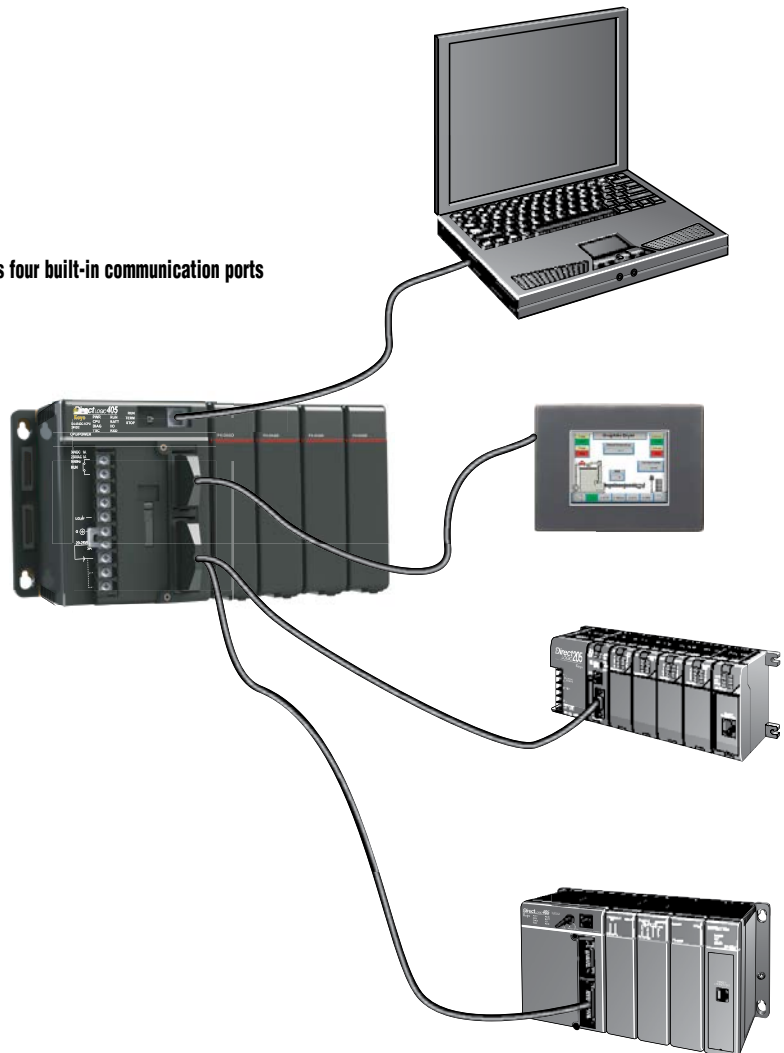

NOTE: Any hardware older than ten years old may not work with the [D4-454](#). We suggest that any hardware older than ten years and not currently sold on the [AutomationDirect.com](#) website be upgraded to a newer version.

D4-454 Features

The diagram on this page shows the various hardware features found on the D4-454 CPU.

D4-454 CPU Hardware Features

CPU Keyswitch																				
RUN	Forces CPU to RUN mode. Locks Comm port - will not receive incoming data.																			
TERM	Allows peripherals (HPP, DCM, DirectSOFT, etc.) to select operating mode																			
STOP	Forces CPU out of RUN																			
CPU Status Indicators																				
PWR	ON OFF	CPU power good CPU power failure																		
RUN	ON OFF	CPU is in RUN mode CPU is in STOP mode																		
CPU	ON OFF	CPU self-diagnostics error CPU self-diagnostics good																		
BATT	ON OFF	CPU battery is low CPU battery is good or disabled																		
DIAG	ON OFF	CPU diagnostics or local bus error CPU diagnostics or local bus good																		
I/O	ON OFF	I/O self-diagnostics error I/O self-diagnostics good																		
TXD	ON OFF	Data is being transmitted No data is being transmitted																		
RXD	ON OFF	Data is being transmitted No data is being transmitted																		
Communications Ports																				
Phone Jack Port 2	General purpose port for RS232. Baud rate is selectable up to 38.4Kb. Connects to DirectSOFT programming software, C-more panels, network, etc. Supports K-sequence protocol, DirectNET (Client or Server) protocol, Non-sequence (ASCII out), and Modbus RTU (Client or Server) protocol.																			
15-pin Port 0	Programming port, RS232, 9600 baud, connects to HPP, DirectSOFT, DV-1000, C-more panels, etc. K-sequence protocol (fixed station address=1)																			
25-pin Port 1 and Port 3	General purpose port for RS232 and RS422 (RS485 Remote I/O Client available on Port 3 only.) Baud rate selectable via software up to 38.4K baud. Connects to DirectSOFT, C-more panels, network, etc. Two logical ports (separate pins on connector). Software selectable protocol includes: <table border="1" style="margin-left: 20px;"> <thead> <tr> <th>Protocol</th> <th>Port 1</th> <th>Port 3</th> </tr> </thead> <tbody> <tr> <td>K-sequence 3</td> <td>3</td> <td></td> </tr> <tr> <td>DirectNET Client/Server</td> <td>3</td> <td>3</td> </tr> <tr> <td>Modbus Client/Server</td> <td>3</td> <td>3</td> </tr> <tr> <td>Remote I/O n/a</td> <td>3</td> <td></td> </tr> <tr> <td>ASCII Out</td> <td>3</td> <td>3</td> </tr> </tbody> </table>		Protocol	Port 1	Port 3	K-sequence 3	3		DirectNET Client/Server	3	3	Modbus Client/Server	3	3	Remote I/O n/a	3		ASCII Out	3	3
Protocol	Port 1	Port 3																		
K-sequence 3	3																			
DirectNET Client/Server	3	3																		
Modbus Client/Server	3	3																		
Remote I/O n/a	3																			
ASCII Out	3	3																		

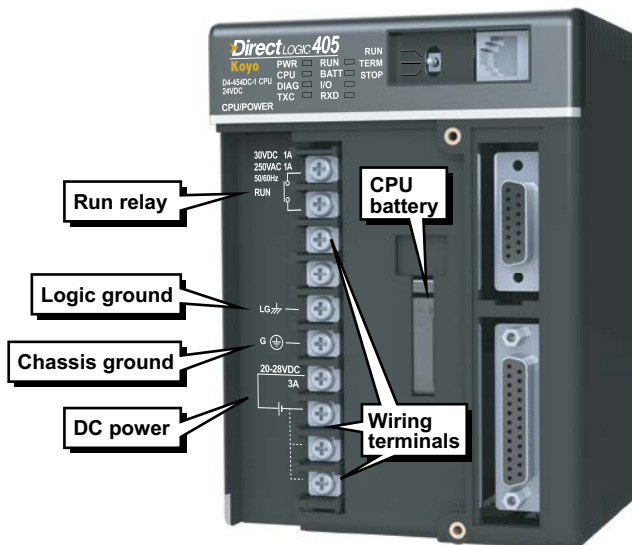

D4-454 communications ports pin-out

Phone jack

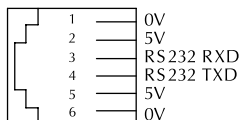

Port 2

15-pin connector

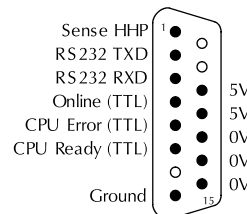

Port 0

25-pin connector

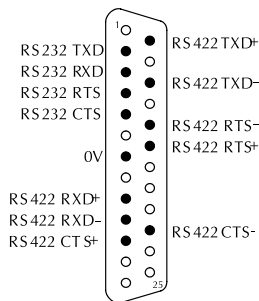

Port 1

25-pin connector

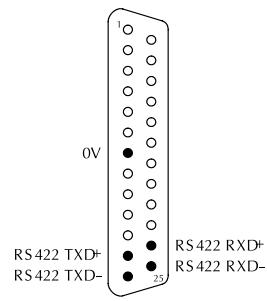

Port 3

D4-454 Features

D4-454 Scan control

The D4-454 CPU provides several scan control options, which are useful in some high-speed machine control applications.

Variable — The scan varies as necessary from scan to scan. The actual scan time depends on the instructions being executed.

Limited — This is similar to a variable scan in that the scan varies as necessary. However, if the actual scan time exceeds a specified target scan time, then a scan overrun condition is indicated.

Fixed — If the scan is finished before the time specified, idle time is added to ensure a fixed scan period. If the scan exceeds the time specified, the scan is extended to ensure all instructions are executed. A scan overrun condition is also reported.

Memory — *The memory of the D4-454 is fully contained in the CPU and stored in MRAM which is a non-volatile form of memory. No memory card is required. The battery is used for retention of the Real Time Clock.*

Full array of instructions

Imagine if someone asked you to write a book, but then told you that you could only use 50 different words? That would be a tough job! The same is true for writing a PLC program. The right instruction can greatly simplify your control program.

The D4-454 supports over 200 powerful instructions. These include:

- Four types of drum sequencers, each with 16 steps and up to 16 outputs
- Leading and trailing edge triggered oneshots
- Bit of word manipulation (bit set, reset, etc.)
- Trigonometric functions
- Floating point conversions
- Ibox instructions that simplify tasks such as configuring analog modules or performing complex math equations

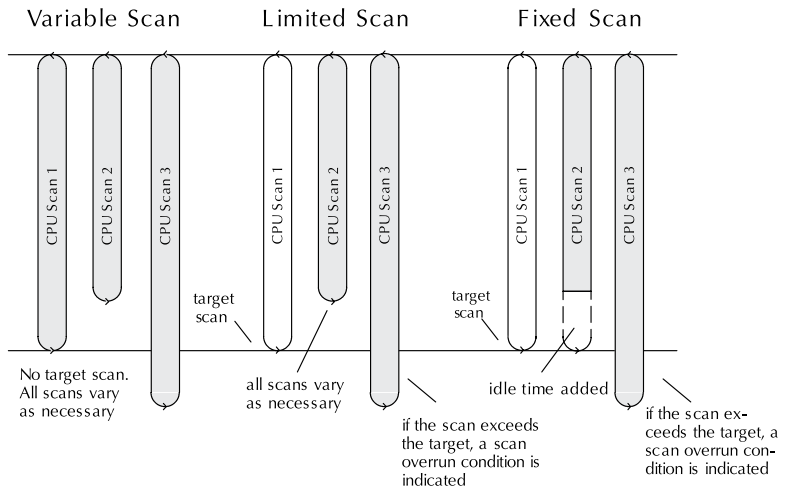

DirectSOFT 6.1 or later,
is required to program the D4-454.

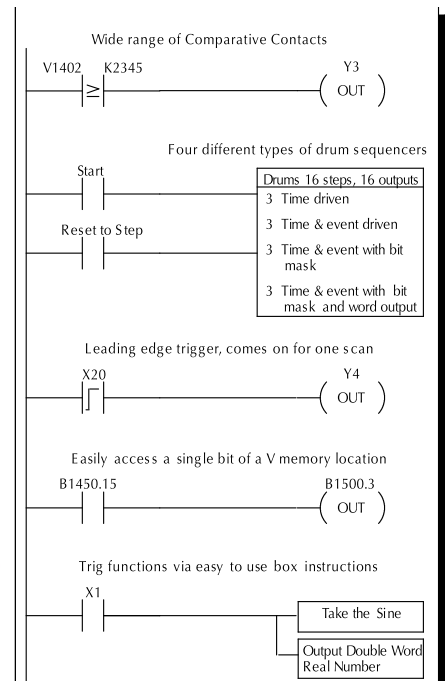

D4-454 PID loops

PID Loop Specifications and Key Features	
Number of Loops	Selectable, 16 maximum
CPU V-memory Required	32 V-memory locations per loop selected (An additional 32 V-memory locations per loop required if using Ramp/Soak)
PID Algorithm	Position or velocity form of the PID equation. Optionally specify direct or reverse acting, square root of the error and error squared control.
Auto Tuning	Open loop step response method and closed loop limit cycle method.
Sample Rate	Specify the time interval between PV samples, 0.05 to 99.99 in units of seconds or minutes. If using all 16 loops, the smallest sample rate is limited to either 0.2 seconds or (PLC scan time x number of loops).
Loop Operation Modes	Loop can be in automatic control, manual (operator) control, or cascade control. PV alarm monitoring continues when loops are in manual mode.
Ramp/Soak	Up to 16 steps (8 ramp, 8 soak) per loop, with indication of Ramp/Soak step.
Square Root PV	Specify a square root of the PV for a flow control application.
Limit SP	Specify a maximum and minimum value for allowable setpoint changes.
Limit OUT	Specify a maximum and minimum value for the output range.
Gain	Specify proportional gain of 0.01 to 99.99.
Reset	Specify integral time of 0.1 to 99.98 in units of seconds or minutes.
Rate	Specify the derivative time, 0.00 to 99.99 seconds.
Rate Limiting	Specify a derivative gain limiting coefficient to filter the PV used in calculating the derivative term (0 to 20).
Bumpless Transfer I	Bias and setpoint are initialized automatically when the loop is switched from manual to automatic. This provides for a bumpless transfer, which reduces the chance of sharp changes in the output as a result of entering automatic mode.
Bumpless Transfer II	Bias is set equal to the Output when the module is switched from manual to automatic. This allows switching in and out of automatic mode without having to re-enter the setpoint.
Step Bias	Provides proportional bias adjustment for large setpoint changes. This may stabilize the loop faster and reduce the chance of the output going out of range. Step bias should be used in conjunction with the normal adjusted bias operation.
Anti-windup	If the position form of the PID equation is specified, the reset action is stopped when the PID output reaches 0 or 100%. Select adjusted bias or freeze bias operation.
Error Deadband	Specify an incremental value above and below the setpoint in which no change in output is made.
Error Squared	Squaring the error minimizes the effect a small error has on the Loop output, however, both Error Squared and Error Deadband control may be enabled.
Alarm Specifications	
Deadband	Specify 0.1% to 5% alarm deadband on all alarms except Rate of Change.
PV Alarm Points	Specify PV alarm settings for low-low, low, high, and high-high conditions. You can also specify a deadband to minimize the alarm cycles when the PV approaches alarm limits.
PV Deviation	Specify alarms to indicate two ranges of PV deviation from the setpoint value (yellow and red deviation).
Rate of Change	Specify a rate-of-change limit for the PV.
<p>Need Temperature Control? If you're only interested in controlling temperature, then there may be a better solution than the D4-454 CPU. Check out the F4-4LTC module. This module has the capabilities of our single loop controllers built into one economical module! Detailed specifications can be found later in this section. This module can directly control up to four loops and it even includes built-in relay outputs for heater or chiller control! If you use the built-in PID capability of the D4-454 CPU, you still have to purchase the analog input modules and the output modules (either discrete or analog) in order to complete the loop. This can result in a much higher overall cost when compared to the F4-4LTC.</p>	

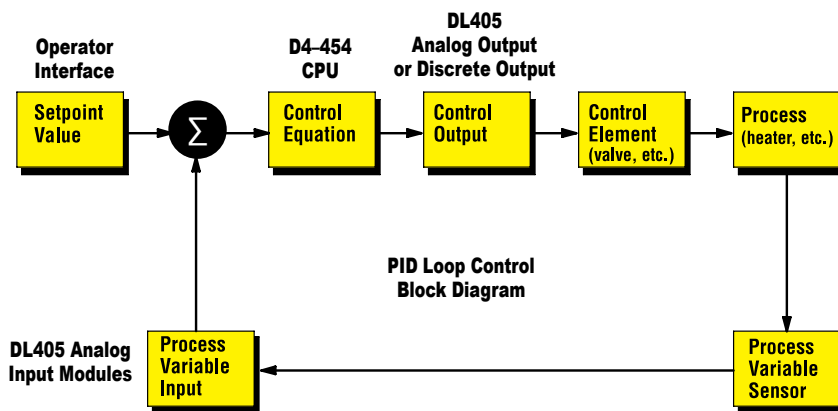

DL405 Programming Tools and Cables

Select a programming device

There are two tools for programming the DL405 CPUs: DirectSOFT PC-based programming software and the D4-HPP-1 handheld programmer.

DirectSOFT programming software

Our powerful Windows-based programming packages make it easy for you to program and monitor your DL405 PLC system. The version of the software that supports the DL405 CPUs is described in the table below. See the DirectLOGIC Overview Section DL in this catalog for detailed information on DirectSOFT.

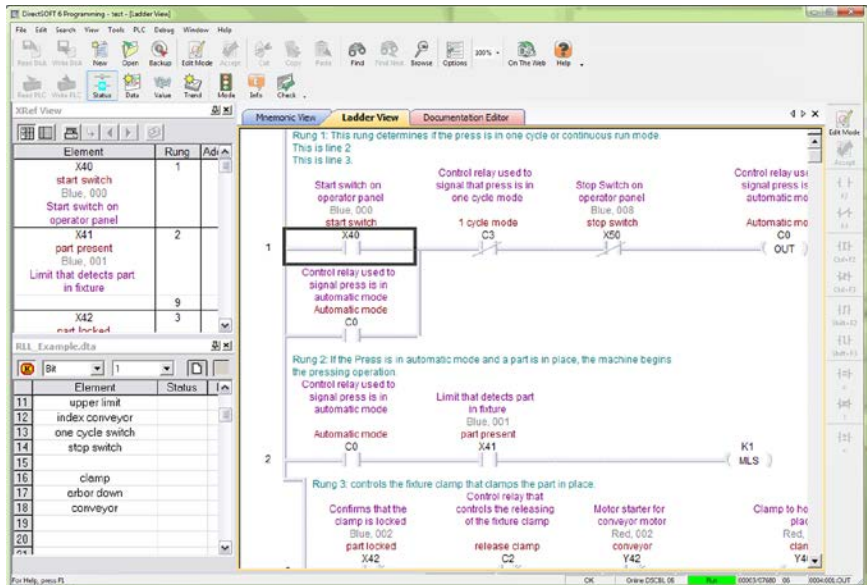

Direct Soft Part Number	Price	Description
D4-HPP-1	Retired	Handheld Programmer
PC-D5OFT6	\$462.00	Programs all PLC families DL05/06/105/205/305/405
PC-DS100	Free	Free version of DirectSOFT; programs all DirectLOGIC PLC CPUs; limited to 100 word program

DL405 programming cables

Choose the proper cable to connect the DL405 CPU to your PC running DirectSOFT.

CPU	Price	Port	Cable	Price
D4-454	\$1,071.00	Top port (15 pin)	D4-DSCBL	\$74.00
		Lower port (25pin)	D3-DSCBL-2	\$66.00
		Phone jack (RJ12)	D2-DSCBL	\$35.00

Pin labeling conforms to IBM DTE and DCE standards

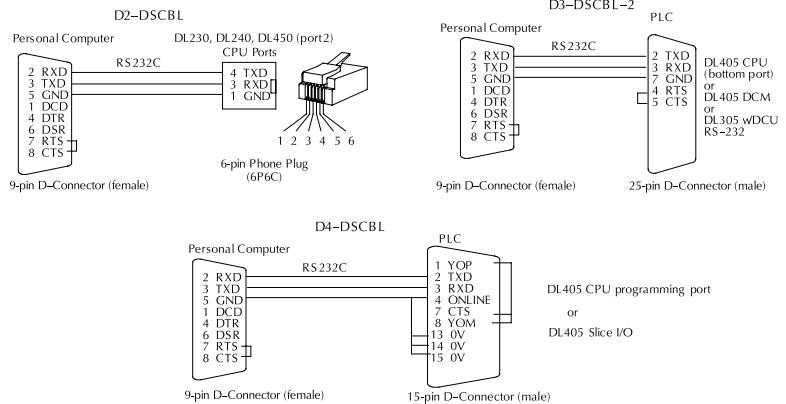

Handheld programmer

The D4-HPP-1 handheld programmer connects to the 15-pin port on any of the DL405 CPUs. A memory cartridge is located on the side of the handheld programmer. This slot allows you to copy memory cartridges (including UV PROMs) and transfer data/programs between the CPU and a memory cartridge.

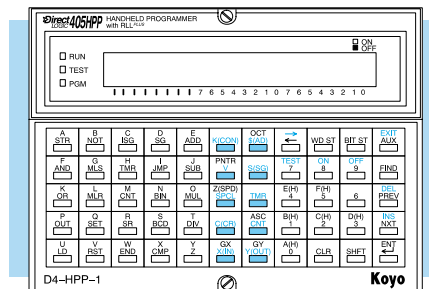

Need Additional Communications Ports?

Do you need communications ports in addition to the built-in CPU communications ports to connect to an operator interface or HMI? Would you like to connect to a network of other AutomationDirect products, or a Modbus RTU or Ethernet network? If yes, then choose between the [H4-ECOM100](#) Ethernet communications module or the [D4-DCM](#) serial data communications module. Both modules' specifications and communications details are covered later in this section.



Note: The D4-454 CPU also supports a Modbus RTU Client module for connection to a Modbus RTU network. This module is listed later in this section.

Ethernet networking with the H4-ECOM100

All DL405 CPUs support the [H4-ECOM100](#) module, which makes Ethernet networking a snap. The [H4-ECOM100](#) module supports industry-standard 10/100Base-T networking with an RJ45 port. The ECOM100 module works with standard cables, switches and repeaters. A virtually unlimited number of PLCs can be connected to an Ethernet network using ECOM modules. This is the fastest data transfer rate we offer for your HMI or other Windows-based software. Use DirectSOFT to program any PLC on the network, and when monitoring your operating PLC, you will see much faster updates with Ethernet and the ECOM modules.

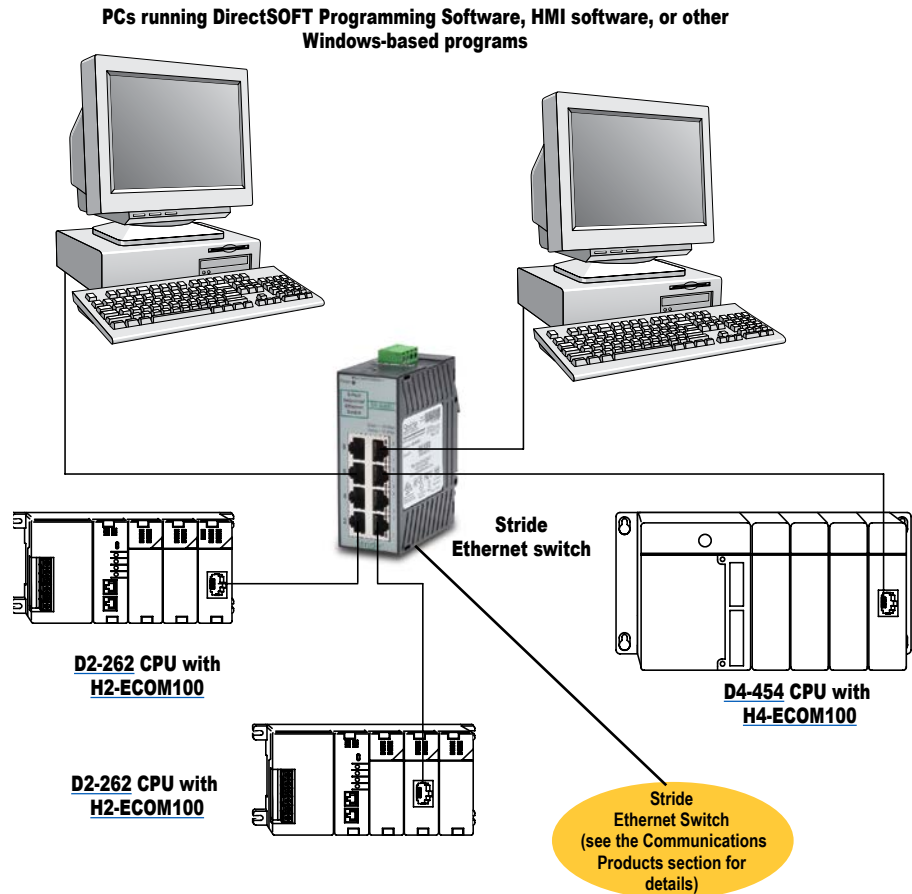

Serial networking with the D4-DCM

All DL405 CPUs support the [D4-DCM](#) Data Communications Module that can serve as a DirectNet Client/Server, DirectNet peer, or a Modbus RTU Server. The D4-DCM supports RS-232 and RS-422 communications. You can program the CPU through the DCM locally, or if a PC is the RS-422 Client, you can use DirectSOFT to program any PLC on the network.

NOTE: Any hardware with a date code less than 09X0 or with a first digit that is not 0, 1, or 2 may not work with the D4-454. We suggest that any hardware older than ten years and not currently sold on the AutomationDirect.com website be upgraded to a newer version.

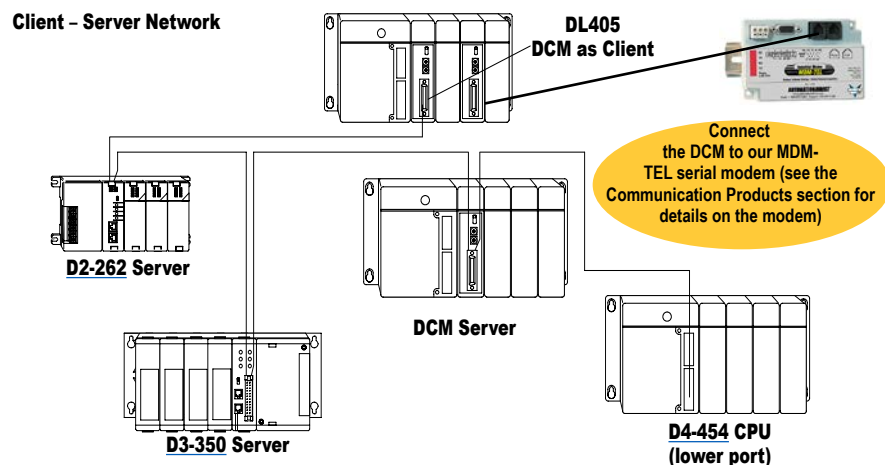

Select the I/O Modules

There are several factors you should consider when choosing an I/O module.

- 1. Environmental specifications:** To what environmental conditions will the I/O modules be subjected?
- 2. Hardware specifications:** Does this product have the right features, performance, and capacity to adequately serve your application?
- 3. Field termination:** How does this module connect to your field devices? For DC modules, do you need a sinking or sourcing module?
- 4. Power budget:** It is very important that your module selections operate within the base power budget. Refer to the power budget description later in this section.

Check the environmental specifications

The following table lists environmental specifications that globally apply to the DL405 system (CPU, Expansion Unit, Bases, and I/O modules). Be sure the modules you choose are operated within these environmental specifications.

Specification	Rating
Storage Temperature	-4°F - 158°F (-20°C to 70°C)*
Ambient Operating Temperature	32°F - 140°F (0° to 60°C)*
Ambient Humidity	5% - 95% relative humidity (non-condensing)**
Vibration Resistance	MIL STD810C, Method 514.2
Shock Resistance	MIL STD810C, Method 516.2
Noise Immunity	NEMA(ICS3-304)
Atmosphere	No corrosive gases

*Storage temperature for the Handheld Programmer is 14° to 149°F (-10° to 65°C).
**Ambient humidity for the Handheld Programmer is 20% to 90% non-condensing.

Review hardware specifications

The hardware specifications for every DL405 module are described later in this section. Discrete module specifications are in a format similar to the example shown. Take time to understand the specification chart, the derating curve, and the wiring diagram. The specialty modules specifications are shown in a format relevant for each module. All of these module specifications should help you determine if the module is right for your application.

Understand the factors affecting field termination

Physical wire terminations: In general, DL405 modules use four types of field terminations. They include: removable terminal blocks (included on all 8 and 16 point modules), specialty D-sub connectors (used on 32 and 64 point modules), standard D-sub connectors (used on most specialty intelligent modules), and phone jack style (used on some specialty modules and included in the universal cable kit).

High-density modules do not come with connectors. To create a custom cable, solder or ribbon-style connectors are sold two per pack, and must be ordered separately. See the individual I/O specification sheets for the part numbers. The easiest way to wire high-density modules is with pre-wired **ZIPLink** cables and connector modules.

Sinking and sourcing for DC field devices: If you are using a DC-type of field device, you should determine whether the device is a sinking or sourcing configuration. This may affect your module selection since it determines the manner in which the device must be wired to the module.

AutomationDirect offers both sinking and sourcing modules. Refer to the Appendix for a complete explanation on sinking and sourcing and how this could affect your system.

NOTE: Any hardware with a date code less than 09X0 or with a first digit that is not 0, 1, or 2 may not work with the D4-454. We suggest that any hardware older than ten years and not currently sold on the AutomationDirect.com website be upgraded to a newer version.

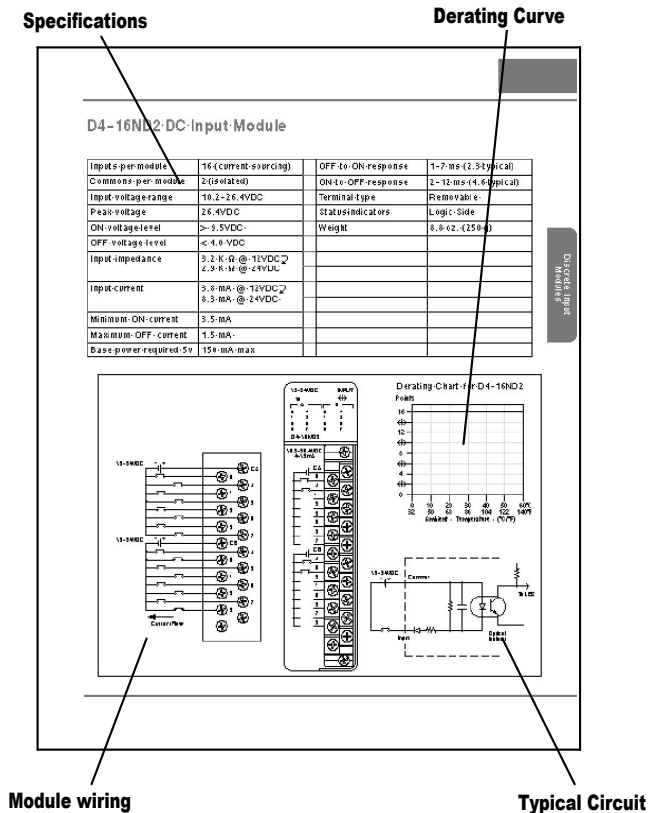

I/O Modules

H4-CTRIO high-speed counter module

Select the H4-CTRIO if your application requires:

- More than one quadrature encoder
- More than one single up counter
- Pulse outputs
- Output operations on the module based on counts, without interaction with the CPU scan

The CTRIO is configured using a Windows-based "Wizard" utility, eliminating the need for ladder logic programming to configure the module. Multiple CTRIO modules can be used in a base to support additional input/output pulse trains.

Analog module selection tips

If you're going to control the speed of an AC inverter or drive with a DL405 analog module, make sure you select the current sourcing F4-04DAS-1 isolated analog output module. Complete module specifications are listed later in this section.

ZIPLink connection systems

ZIPLinks consist of PLC interface cables and connector modules that offer "plug and play" capability by plugging one end of the ZIPLink cable into an I/O module and the other end into the ZIPLink connector module. This eliminates the tedious process of wiring PLC I/O to terminal blocks. For more information, refer to Wiring System for DL405 PLCs later in this chapter or the Wiring Solutions section in this catalog.

DINnectors terminal blocks

DINnectors are DIN rail mounted connectors or terminal blocks. All DINnectors are UL, CSA, VDE, SEV, RINA and IEC approved. Refer to the Terminal Blocks section of this catalog for details.

Need spare parts?

Sometimes it is helpful to have extra I/O module connectors or spare fuses. The DL405 spare parts and accessories are listed below:

• D4-FUSE-2 (\$23.00)	Fuses for F4-08TRS-2
• D4-FILL (\$27.00)	Filler module to cover empty I/O slots
• (retired)	16-pt. module terminal blocks
• D4-IOCVR (\$11.00)	Replacement terminal block covers
• ZL-D24-CON-R (Retired)	32/64-pt. ribbon-style connectors
• ZL-D24-CON-X (\$89.00)	32/64-pt. solder-style connectors

Next steps?

Now that you understand the factors affecting your choice of I/O modules, it's time to choose the ones that best fulfill your needs. Review the module specifications later in this section. If you have any questions, give us a call. When you have selected the modules you need, proceed to the next section to choose an I/O configuration scheme that best suits your application.

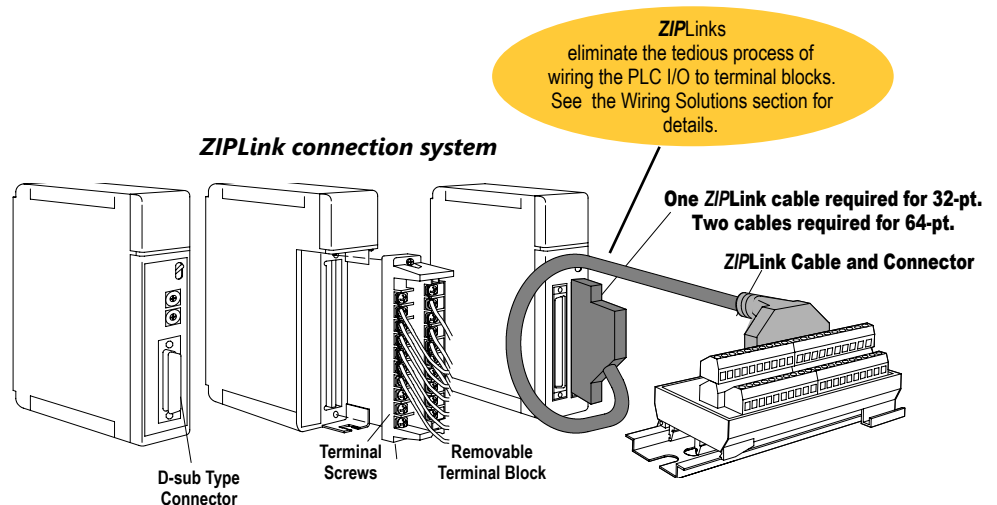

DINnectors terminal blocks

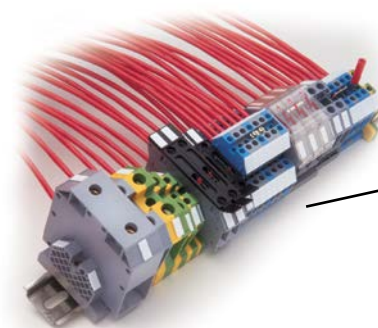

Select an I/O Configuration

Four configurations for system flexibility

The DL405 system offers four major configurations of I/O. The choices are described on the following two pages. Keep these choices in mind as you plan your I/O system.

Local I/O

The local base is the base that holds the CPU. The term "local I/O" refers to the modules that reside in the base with the CPU. Each local I/O point is updated on every CPU scan. Up to 512 points are available in the local base by using 64-point modules.

Expansion I/O

Expansion bases are commonly used when there are not enough I/O slots available in the local base, or when the power budget for the base will be exceeded with the addition of I/O. This configuration requires additional base(s), each of which require a D4-EX Local Expansion Unit in place of the CPU, and a cable to connect the expansion bases to the local CPU base. Up to three expansion bases can be connected to a local CPU base, for a total of four bases. The CPU updates expansion I/O points on every scan. The total number of local and expansion I/O points for the D4-454 is 2048 points.

Example of I/O system configuration

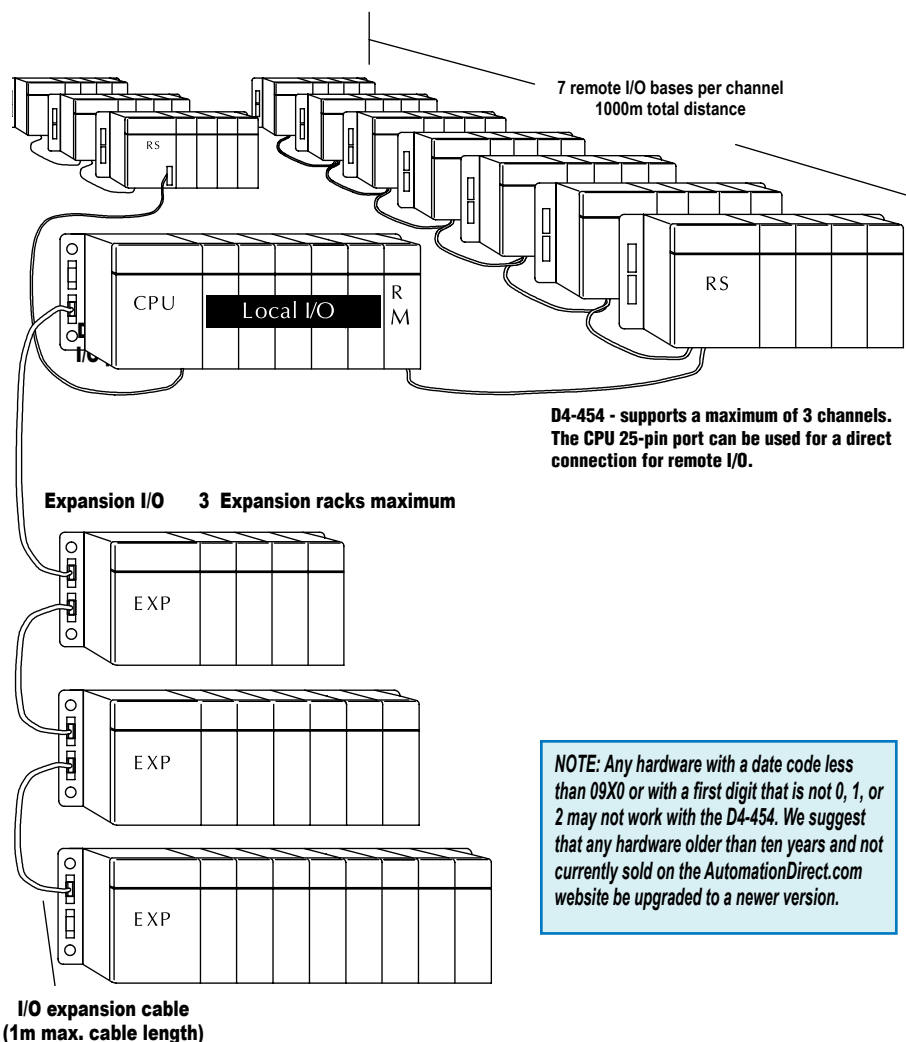

I/O Configurations

Ethernet remote I/O

The DL405 Ethernet Remote I/O system allows you to locate I/O bases at a remote distance from the CPU. For many applications, this can reduce wiring costs by allowing I/O points to be located near the devices they are controlling.

The Ethernet Remote Client module ([H4-ERM100](#)) is placed in an I/O slot of the local CPU base. Ethernet Base Controller (EBC) modules serve as the Remote Server Units and are placed in the CPU slot of one or more remote bases. You can use standard DL405 modules in the remote bases. The Remote Servers are connected to the Client using Category 5 UTP cables for cable runs up to 100 meters. Use repeaters to extend distances and hubs to expand the number of nodes.

Each [H4-ERM100](#) module can support up to 16 Servers: 16 H2-EBC systems, 16 Terminator I/O EBC systems, or 16 fully expanded H4-EBC systems.

The PLC, ERM and EBC Server modules work together to update the remote I/O points. These three scan cycles are occurring at the same time, but asynchronously. It is recommended that critical I/O points that must be monitored every scan be placed in the CPU base.

ERM Workbench is an easy-to-use Windows-based software utility that is used to configure the ERM and its remote Servers.

It is highly recommended that a dedicated Ethernet remote I/O network be used for the ERM and its Servers. While Ethernet networks can handle a very large number of data transactions, and normally handle them very quickly, heavy Ethernet traffic can adversely affect the reliability of the Server I/O and the speed of the I/O network. Keep ERM networks, multiple ERM networks and ECOM/office networks isolated from one another.

I/O Configuration Specifications		D4-454
Total Channels Available	Total number of Remote channels available	3
Remote I/O	Maximum number of D4-RM per system	2
	Number of Clients built into CPU port	1
	Maximum I/O points supported per channel	512
	Maximum I/O points supported	1536
	Maximum number of remote I/O bases per channel	7

Serial remote I/O

Remote I/O solutions allow you to place I/O points at some remote distance from the CPU. The remote I/O points are updated asynchronously to the CPU scan. For this reason, remote I/O applications should be limited to those that do not require the I/O points to be updated on every scan.

Remote I/O requires a remote Client to control the remote I/O channel. This Client can be a module ([D4-RM](#)) in the local CPU base, or the [D4-454](#) CPU (through the 25-pin port). For the D4-RM solution, the CPU updates the remote Client, then the remote Client handles all communication to and from the remote I/O base by communicating to the remote Server module ([D4-RS](#)) installed in each remote base. The [D4-454](#) CPU communicates directly with the [D4-RS](#).

The maximum distance between a Remote Client and a Remote Server is 3,300 feet (1000 meters).

Module Placement and I/O Usage Tables

I/O module placement restrictions

The most commonly used I/O modules for the DL405 system (AC, DC, AC/DC, Relay, and Analog) can usually be used in any base you have in your local, expansion or remote system. However, some specialty modules (and the 64pt discrete I/O modules) are limited to the CPU base, or our D4-xxB-1 bases. This table lists by category the valid locations for all modules/units in a DL405 system. Keep in mind the power budget may limit where some modules can be placed, since the necessary power may have been consumed.

I/O point usage table for modules

The bottom tables indicate the number of I/O points consumed by each module. Use this information to ensure you stay within the I/O count of the I/O configuration you have chosen. Remember, each CPU supports a different amount of I/O. Check the specifications to determine the I/O limits.

Module/Unit	Local CPU Base	Expansion Base 1	Remote Base
CPUs	CPU slot only		
Expansion Units		CPU slot only	
8/16/32pt DC Input	✓	✓	✓
64pt DC Input	✓ ²		
AC Input	✓		
AC/DC Input	✓	✓	✓
8/16/32pt DC Input	✓	✓	✓
64pt DC Output	✓ ²	✓	✓
DC Input	✓	✓	✓
Relay Output	✓	✓	✓
Analog Input and Output	✓	✓	✓
Thermocouple Input	✓	✓	✓
Remote I/O			
Remote Clients (serial / Ethernet)			
Remote Server Unit	✓	✓	CPU slot only
Communications and Networking Modules			
Coprocessor Modules	✓		
Specialty Modules	✓		
Interrupt w/D4-454			
PID	✓		
4-Loop Temp. Controller	✓		
High-speed Counter	✓	✓	
Simulator	✓	✓	✓
1 – H4-CTRIO may not be installed in a CPU expansion base. ✓			
2 – If you are using 64pt modules, you cannot install any specialty modules in slots 5,6, or 7 of the local base.			

I/O points required per module

DC Input	I/O pt.
D4-16ND2	16 in
D4-16ND2F	16 in
D4-32ND3-1	32 in
D4-64ND2	64 in
AC Input	
D4-08NA	8 in
D4-16NA	16 in
AC/DC Input	
D4-16NE3	16 in

DC Output	I/O pt.
D4-16TD1	16 out
D4-16TD2	16 out
D4-32TD1, (D4-32TD1-1)	32 out
D4-32TD2	32 out
D4-64TD1	64 out
AC Output	
D4-08TA	8 out
D4-16TA	16 out
Relay Output	
D4-08TR	8 out
F4-08TRS-1	8 out
F4-08TRS-2	8 out
D4-16TR	16 out

Analog	I/O pt.
F4-04AD	16 or 32 in
F4-04ADS	16 in
F4-08AD	16 in
F4-16AD-1, (-2)	16 in
F4-04DA-1, (-2)	16 out
F4-04DAS-1	32 out
F4-08DA-1, (-2)	16 out
F4-16DA-1, (-2)	32 out
F4-08RTD	32 in
F4-08THM-n	16 in
F4-08THM	32 in
Communications/Networking	
All modules	0
Coprocessors	
All modules	0

Remote I/O	I/O pt.
H4-ERM100	0
D4-RM	0
D4-RS	0
Specialty Modules	
H4-CTRIO	0
D4-16SIM	8 or 16 in
F4-4LTC	0

DL405 I/O Addressing

Many of our customers are familiar with other PLC systems prior to trying DirectLOGIC products. One of the key differences between various PLC systems is how they treat the I/O module addressing. This section will describe how we address the individual I/O points in a DL405 system.

Octal addressing

The DL405 uses octal addressing. That is, the I/O point addresses do not include any "8s" or "9s". The I/O points start at 0 and continue in increments of 8, 16, 32, or 64 points, depending on the modules being used. We use the designator "X" for inputs and "Y" for outputs.

Automatic addressing

The DL405 CPUs automatically examine any I/O modules in the local CPU and expansion bases to establish the correct I/O configuration and addressing on power-up. The modules don't have to be grouped by type and the discrete input and output modules can typically be mixed in any order. However, there may be restrictions placed on some specialty modules or combinations of modules (Check the Module Placement restrictions). The following diagram shows sample addresses for a simple system containing discrete I/O modules.

For most applications, you never have to change or adjust the configuration. However, if you use automatic addressing and you add modules in between existing modules, the I/O addresses may be subject to renumbering. If you want to add modules in the future, add them to the right of any existing modules to avoid any re-addressing of your I/O points, or use manual addressing.

Manual addressing

The D4-454 CPU allows you to manually assign I/O addresses for any or all I/O slots on the local or expansion bases. This feature is useful if you have a standard configuration that you must sometimes change slightly to accommodate special requests. It is also useful if you have to leave empty slots in between I/O modules and you do not want an added module to cause addressing problems. In automatic configuration, the addresses are assigned on 8-point boundaries. Manual configuration assumes that all modules are at least 16 points, so you can only assign addresses that are a multiple of 20 (octal). This does not mean you can only use 16, 32, or 64-point modules with manual configuration. You can use 8-point modules, however 16 addresses will be assigned and 8 are unused.

Remote I/O addressing

Remote I/O is very flexible when it comes to I/O addressing. For example, you specify the starting addresses, number of total points, etc. when you set up the system.

Manual addressing and choice of data type designators

With Remote I/O, you can choose the designator type that is used for the addresses. For example, you could choose to map the remote points into GX data types or GY data types or even into control relays. This can be very helpful in those situations where the local and expansion I/O have consumed all of the X inputs or Y outputs. You make these various choices when you define the setup logic for the remote I/O.

Automatically Assigned Module Addresses

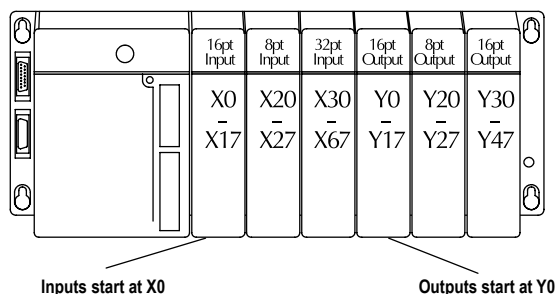

Manually Assigned Module Addresses

